

Coupling ANSA and META to LS-OPT

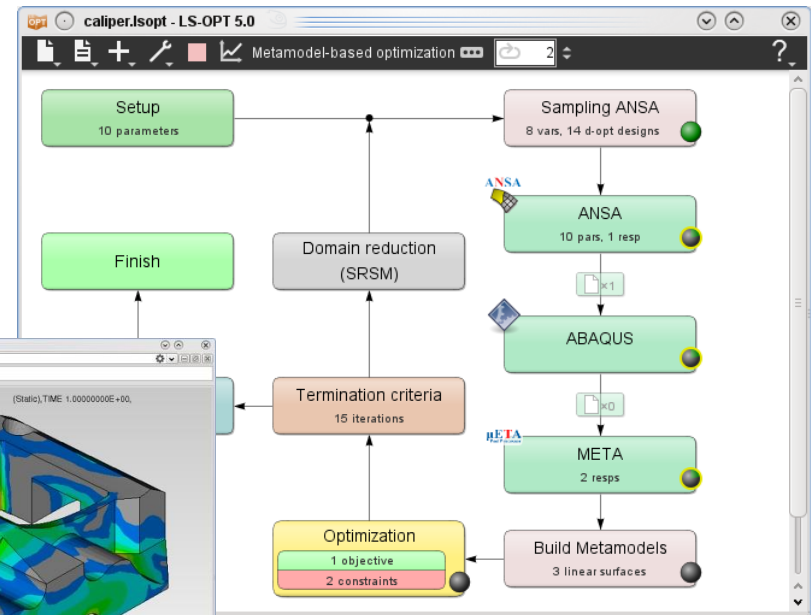
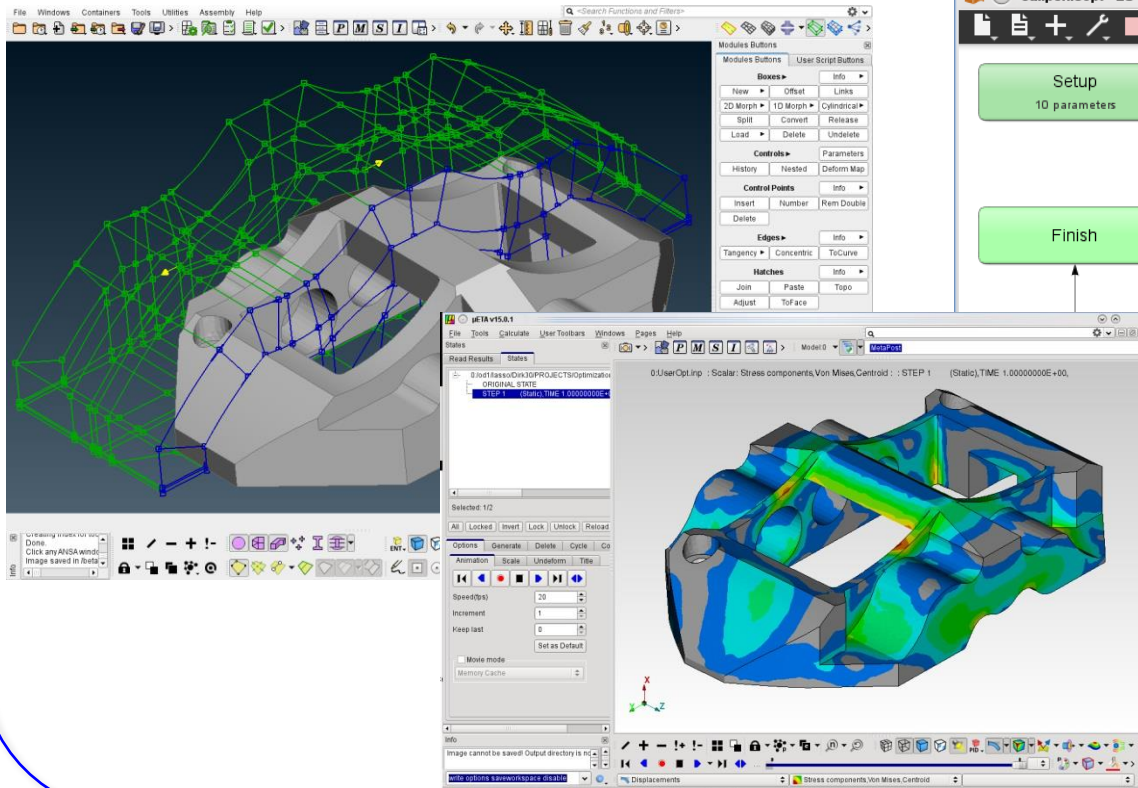

Dirk Dreißig
Mail: ansa@lasso.de

For what **ANSA** & **META**?

- **ANSA** for model/shape change according to design variables (parameters in text files can be handled directly from LS-OPT)
- **META** for results extraction of arbitrary solvers (LS-DYNA results or text files can be handled directly)
- **Setup phase**
 - design variables defined in **ANSA** → transfer to **LS-OPT**
 - histories and responses defined in **META** → transfer to **LS-OPT**
- **Optimization (Run) phase**
 - design variables controlled by **LS-OPT** → transfer to **ANSA**
 - histories and responses calculated by **META** → transfer to **LS-OPT**

Optimization Setup

ANSA → Solver → META → LS-OPT

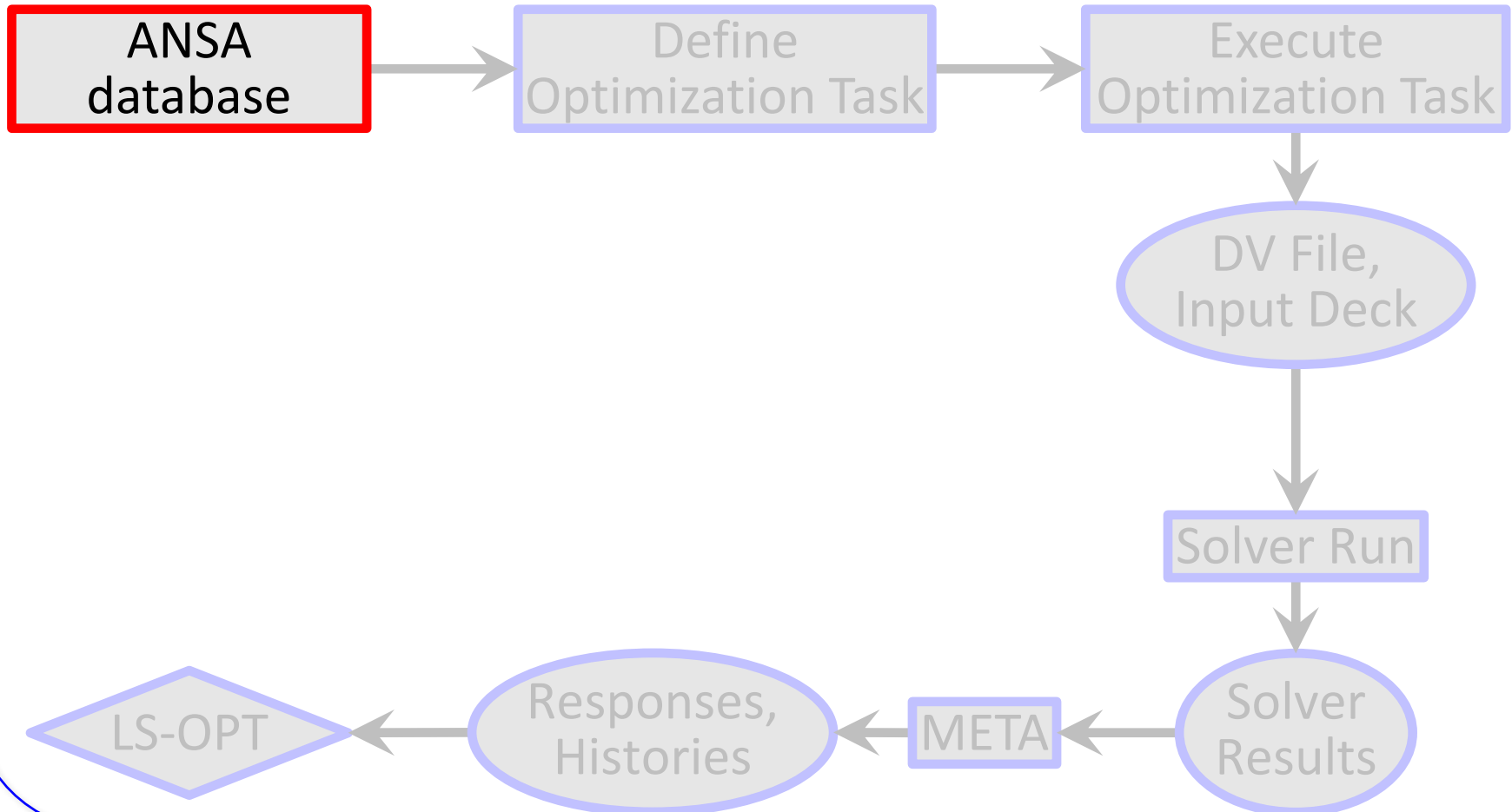

Optimization Setup

ANSA → Solver → META → LS-OPT

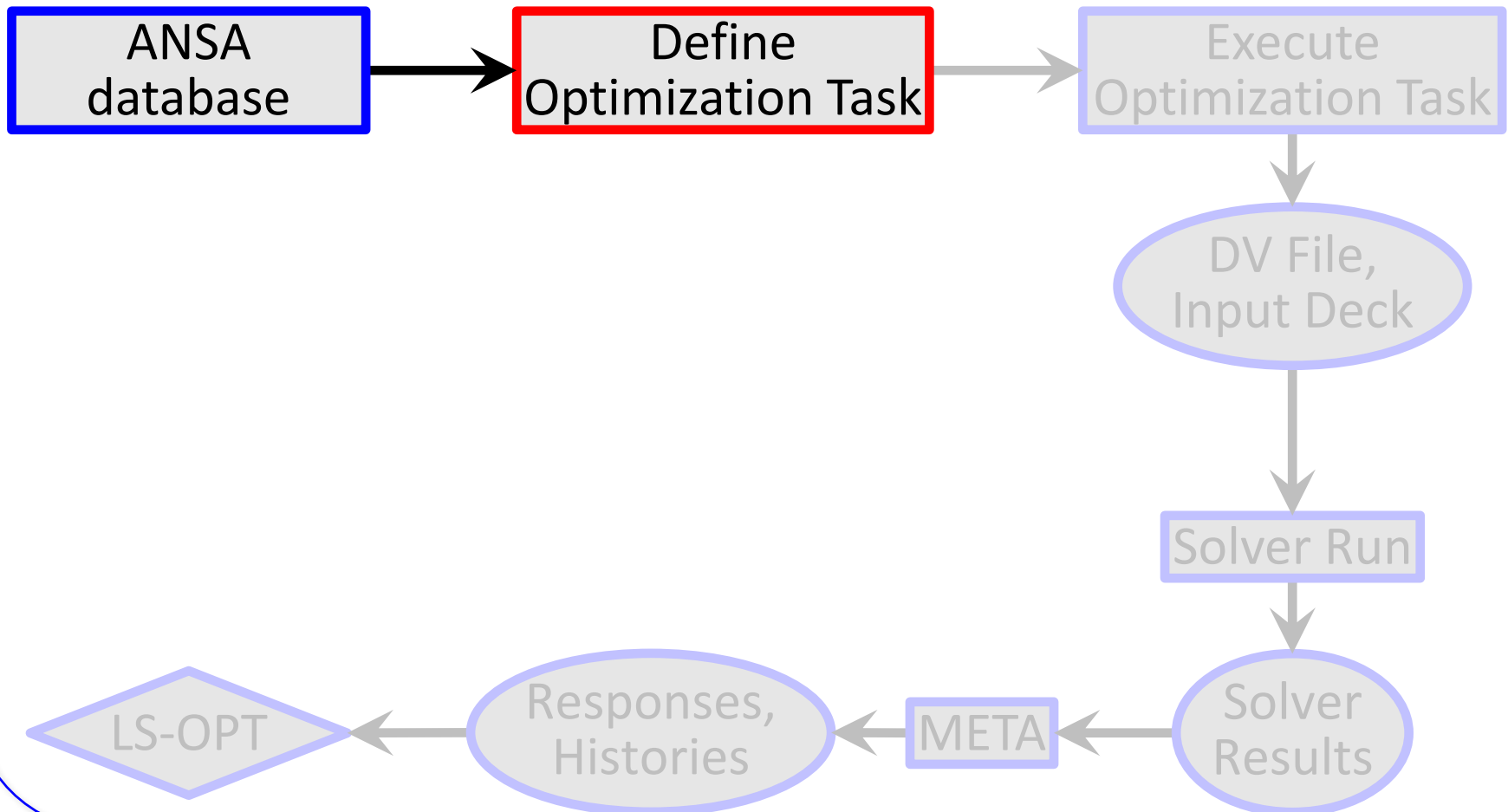

Optimization Setup

ANSA → Solver → META → LS-OPT

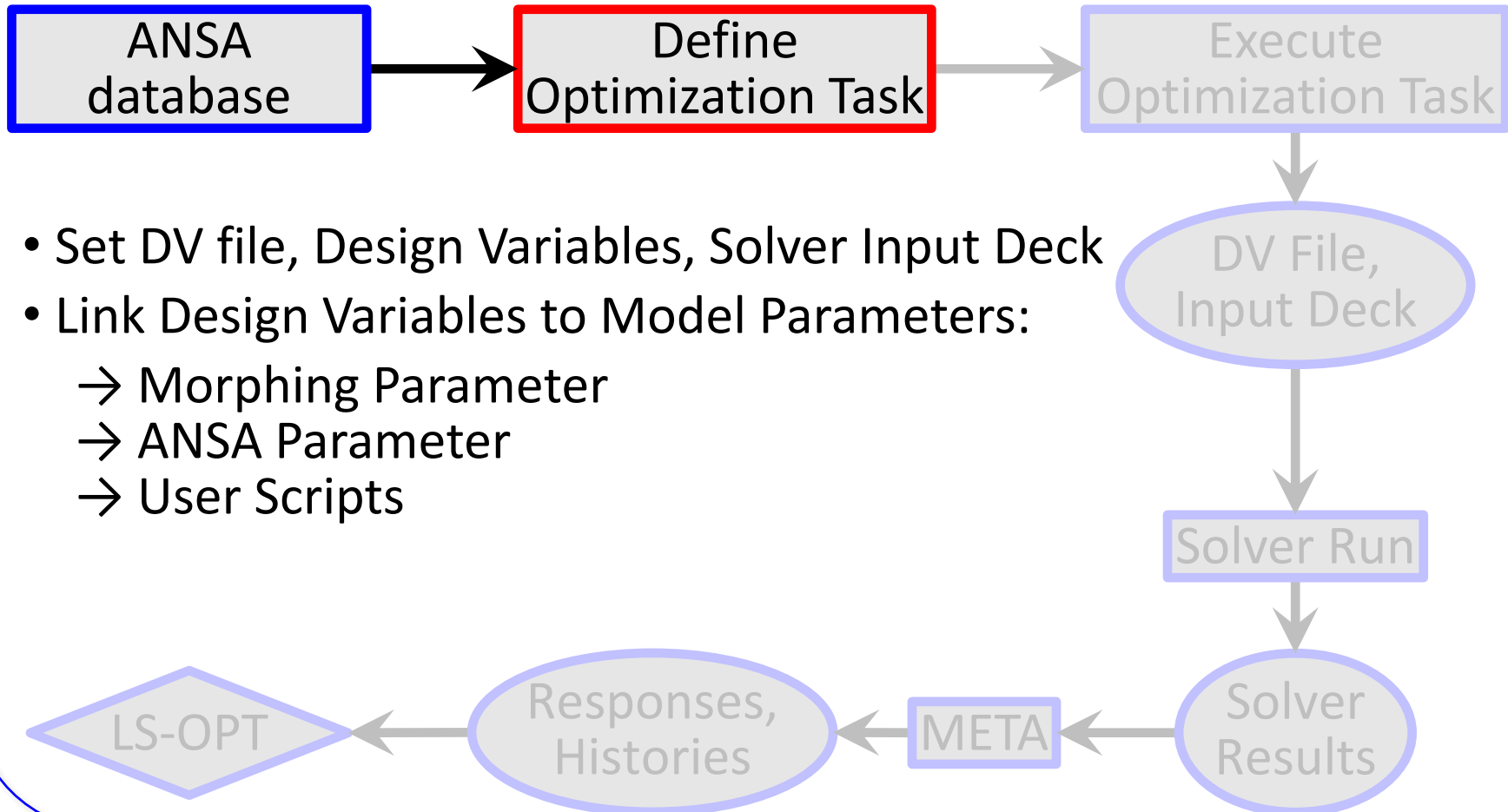

Optimization Setup

ANSA → Solver → META → LS-OPT

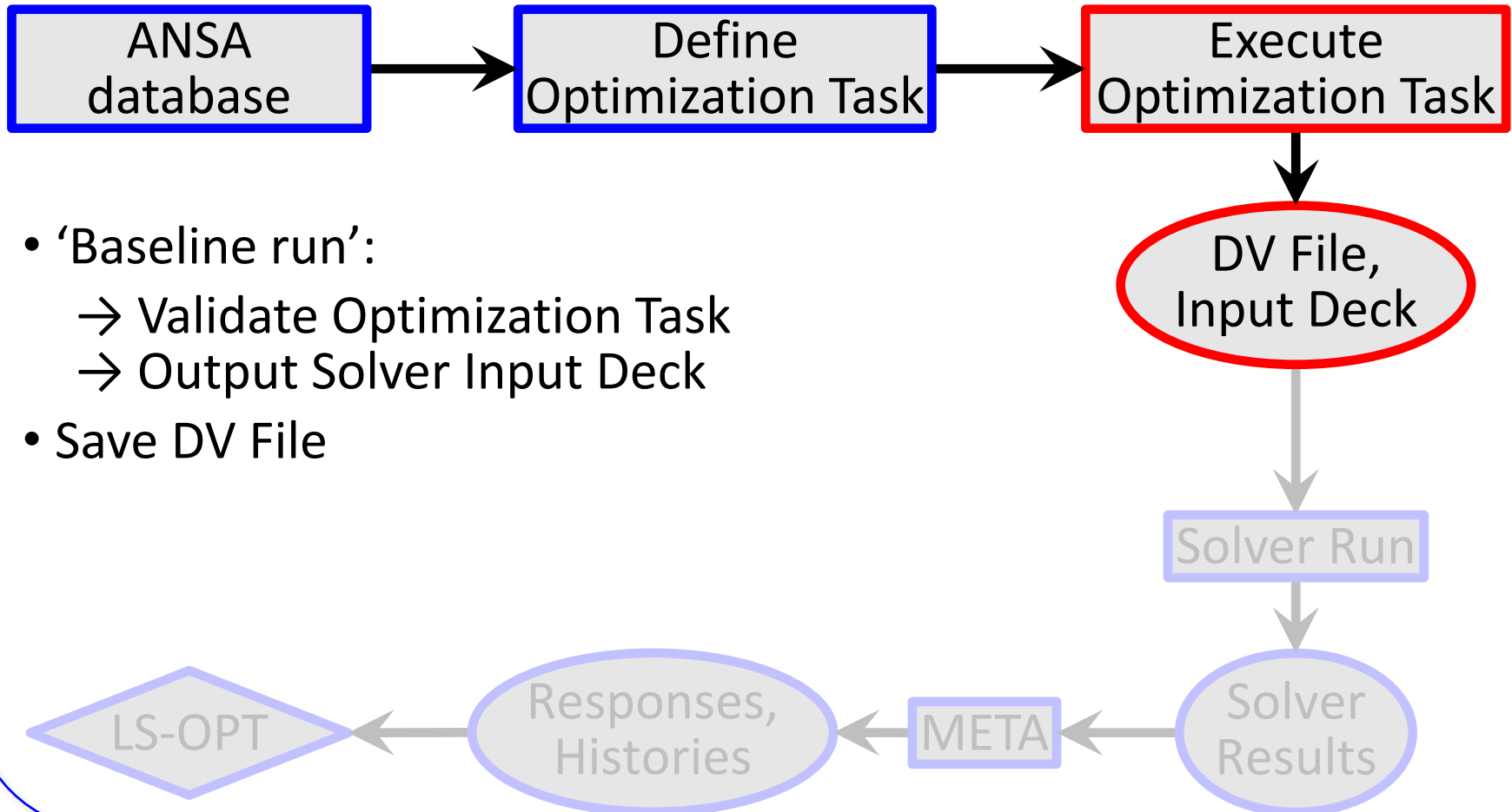

Optimization Setup

ANSA → **Solver** → META → LS-OPT

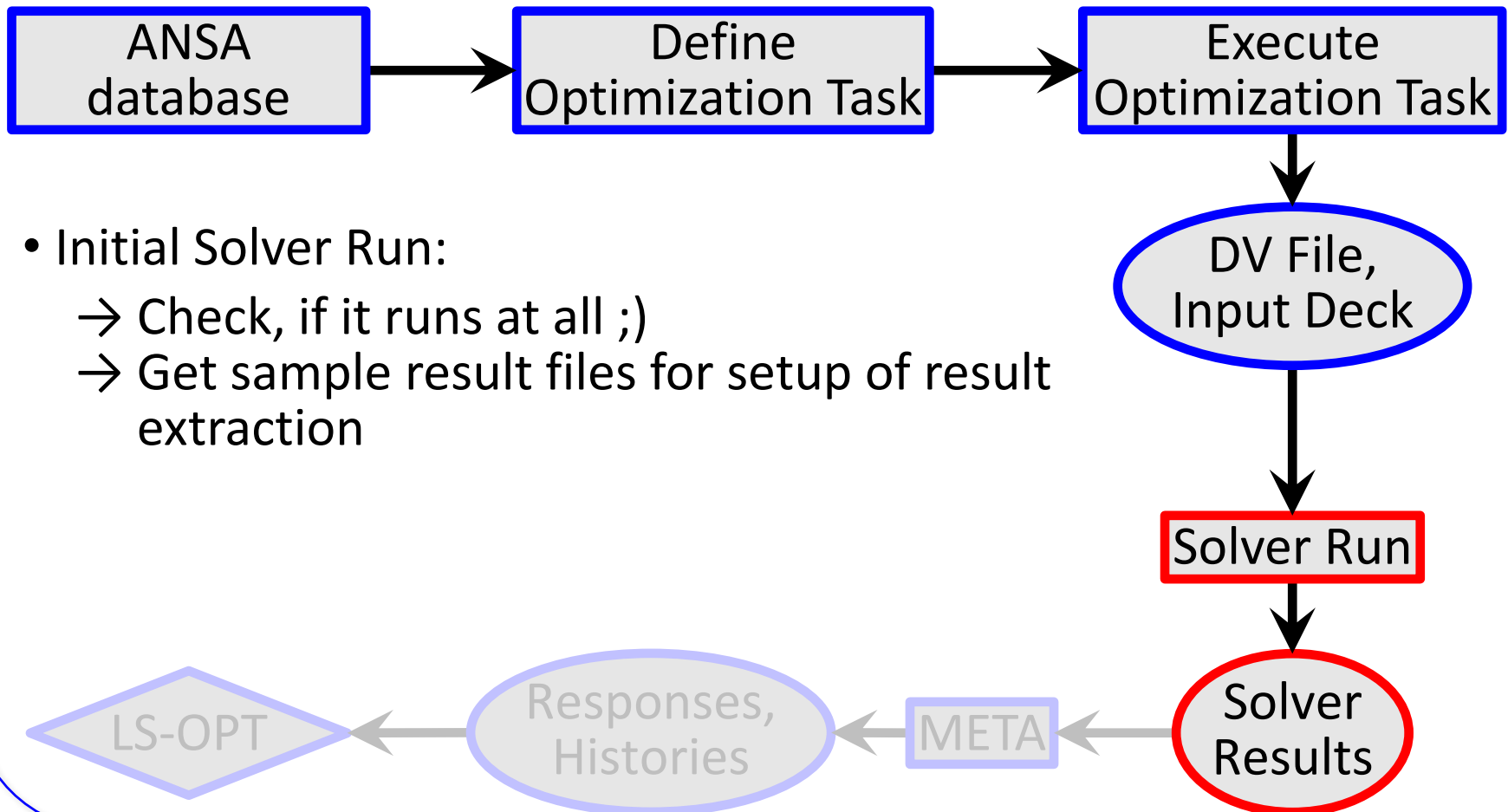

Optimization Setup

ANSA → Solver → **META** → LS-OPT

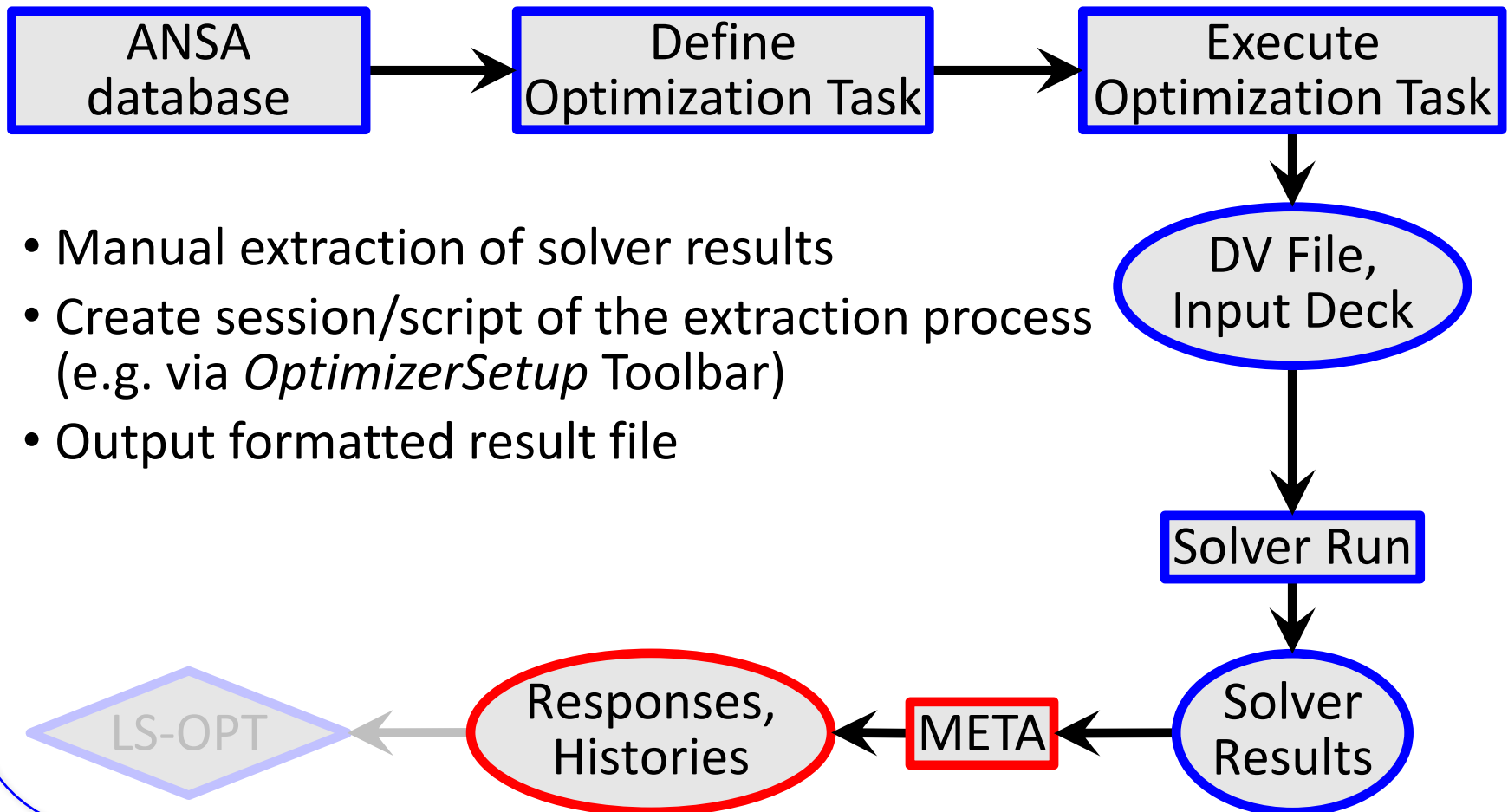

Optimization Setup

ANSA → Solver → META → **LS-OPT**

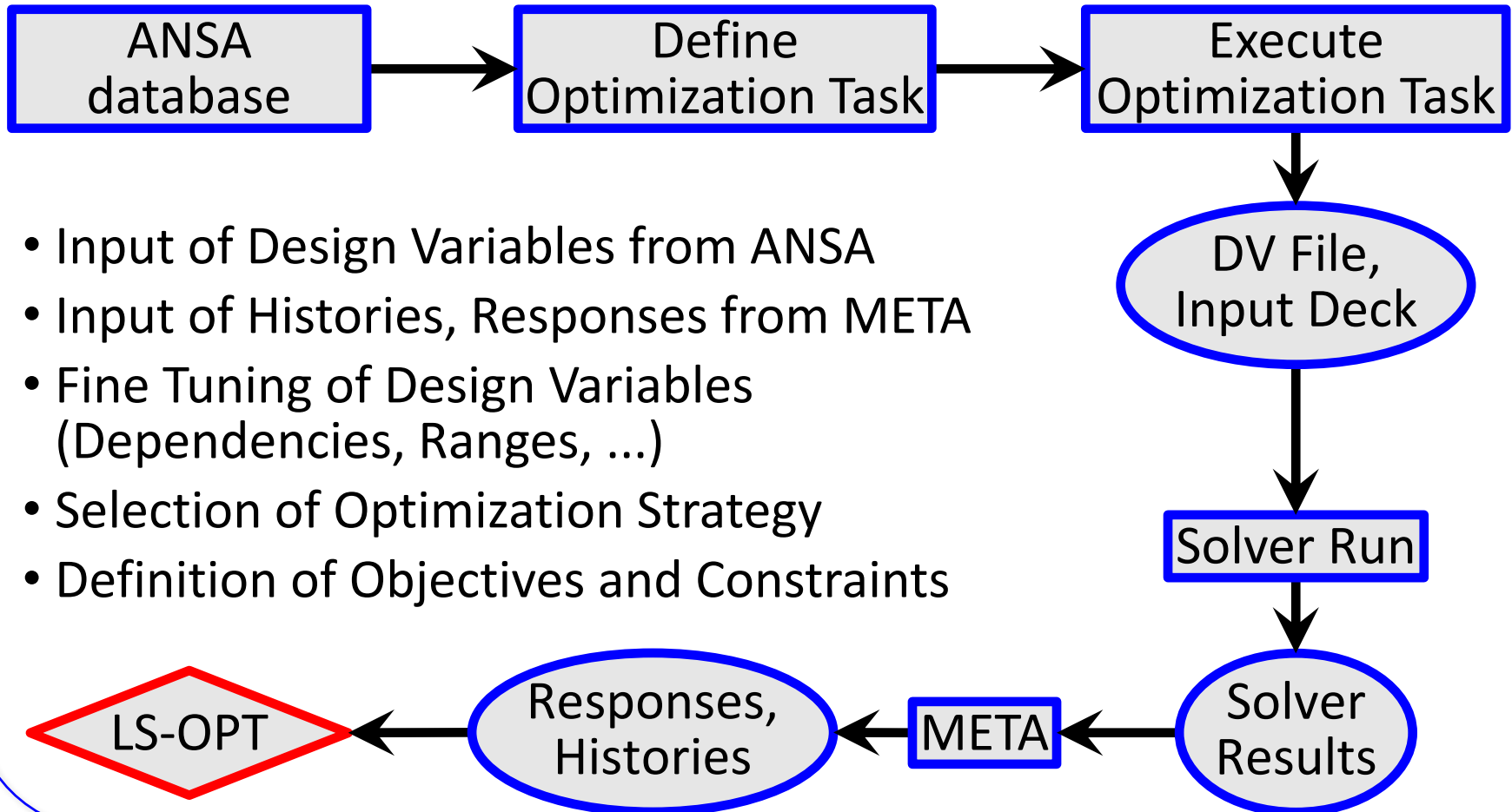

ANSA – Optimization Task

3 main task items

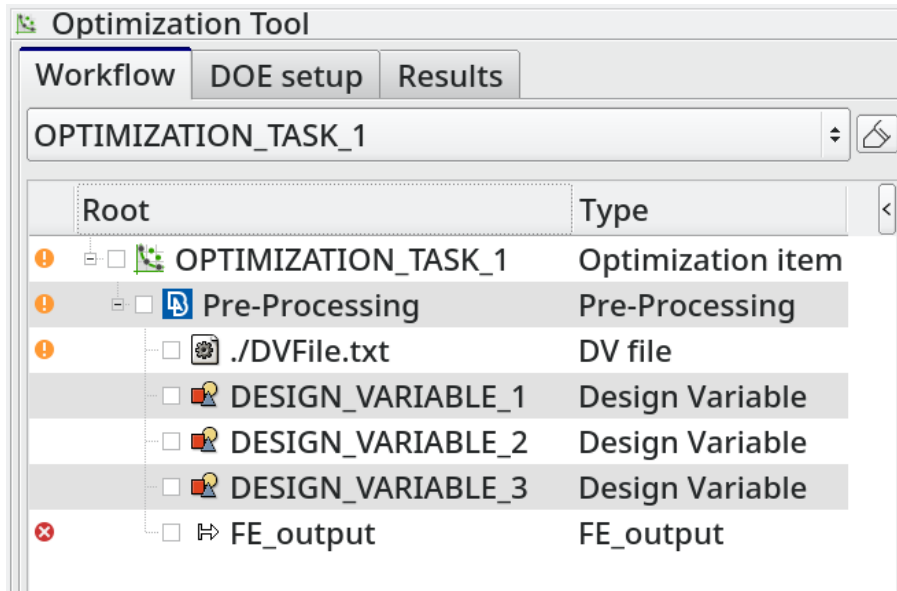

ANSA – Optimization Task

3 main task items

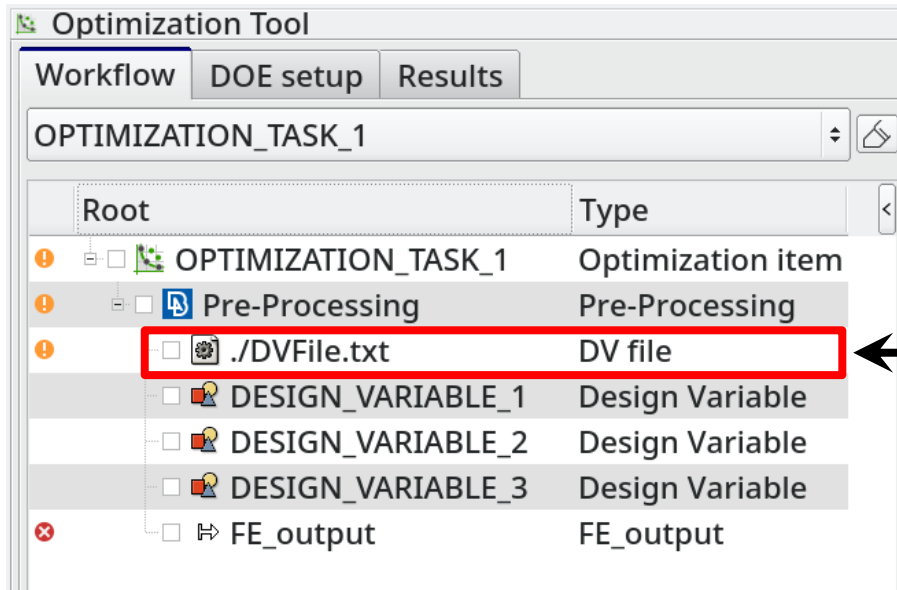

1. Design Variable File

ANSA – Optimization Task

3 main task items

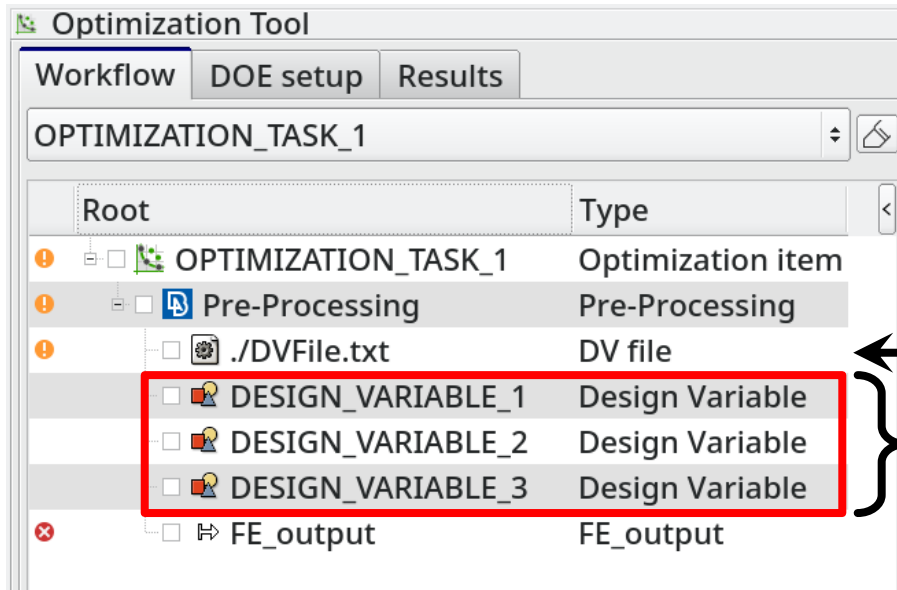

1. Design Variable File

2. Design Variables

ANSA – Optimization Task

3 main task items

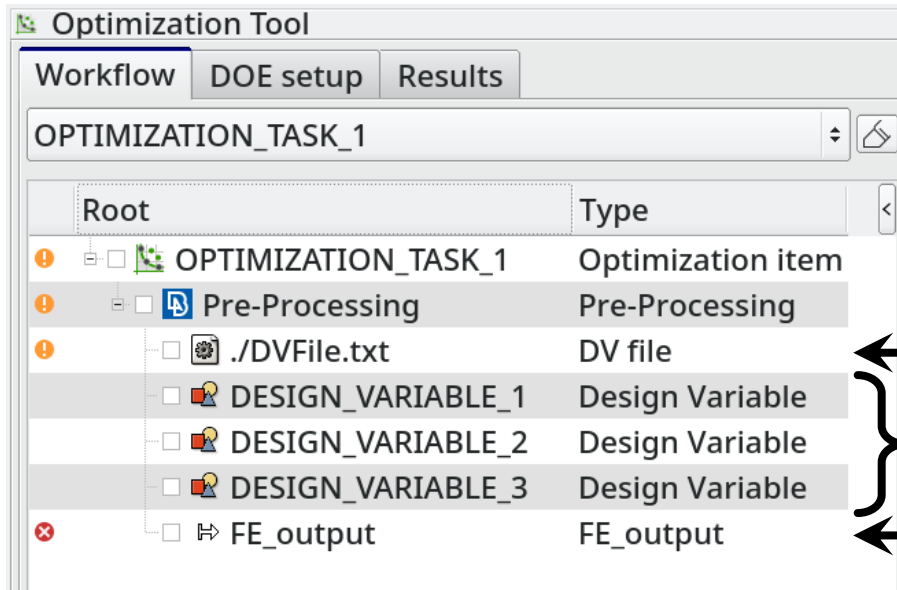

1. Design Variable File
2. Design Variables
3. Output Solver Deck

ANSA – Optimization Task

Design Variable File

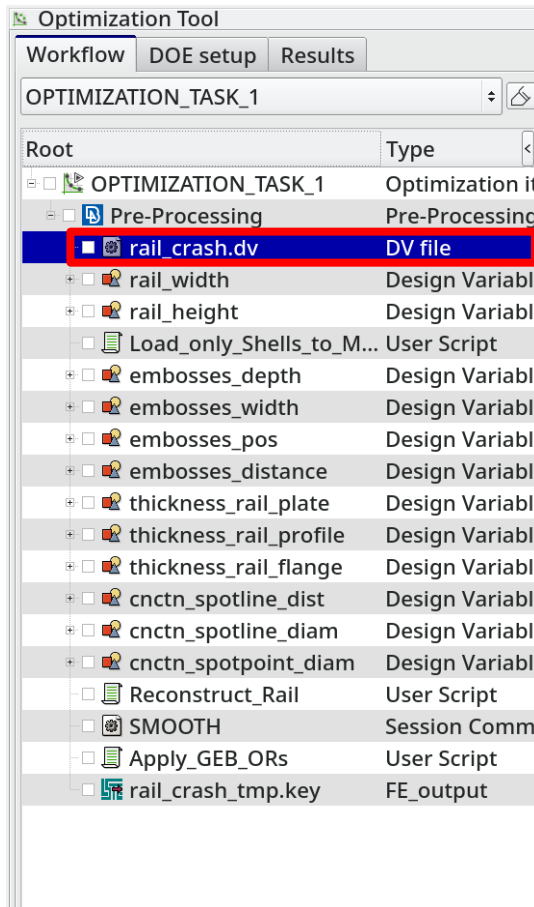

```
#
# ANSA_VERSION: 14.2.3
#
# file created by  A N S A  Mon Feb 17 17:13:25 2014
#
# Output from:
# /od1/lasso/Dirk30/PROJECTS/Optimierung_Rail_LS-OPT/Rail_MD0/rail_crash.ansa
#
# DESIGN VARIABLES
#-----
# ID | DESIGN VARIABLE NAME | TYPE | RANGE | CURRENT VALUE | MIN VALUE -->  MAX VALUE | STEP
#-----
10, rail_width, REAL, BOUNDS, 10., -20., 20.
11, rail_height, REAL, BOUNDS, 10., -20., 20.
1, embosses_depth, REAL, BOUNDS, 7., 0., 7.
3, embosses_width, REAL, BOUNDS, 10., -10., 10.
2, embosses_pos, REAL, BOUNDS, -15., -50., 20.
7, embosses_distance, REAL, BOUNDS, -15., -15., 50.
4, thickness_rail_plate, REAL, STEP, 1.5, 0.5, 2., 0.1
5, thickness_rail_profile, REAL, STEP, 1.5, 0.5, 2., 0.1
8, thickness_rail_flange, REAL, STEP, 1.5, 0.5, 3., 0.1
6, cnctn_spotline_dist, REAL, BOUNDS, 50., 20., 100.
9, cnctn_spotline_diam, REAL, STEP, 5., 2., 10., 1.
12, cnctn_spotpoint_diam, REAL, STEP, 5., 2., 10., 1.
#-----
```

Correctly formatted for
import in LS-OPT

ANSA – Optimization Task

Design Variables → Morphing Parameters

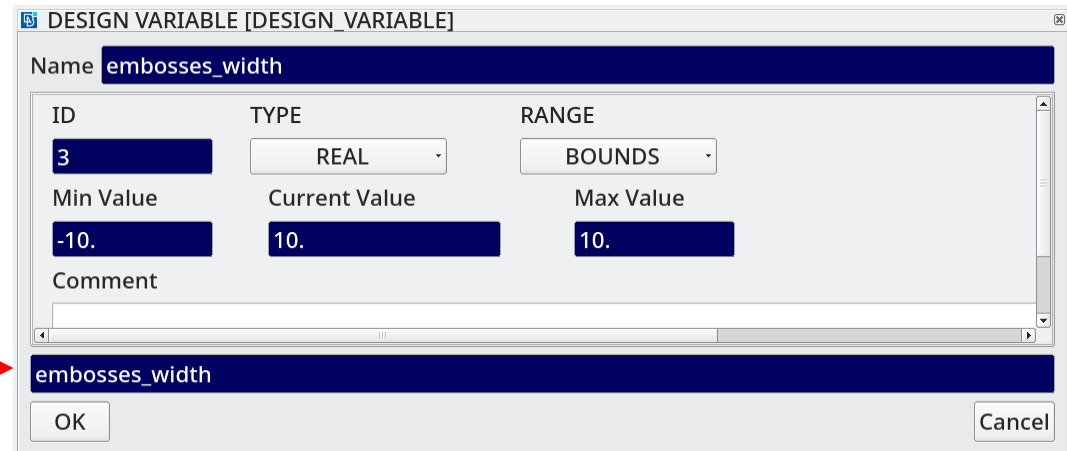
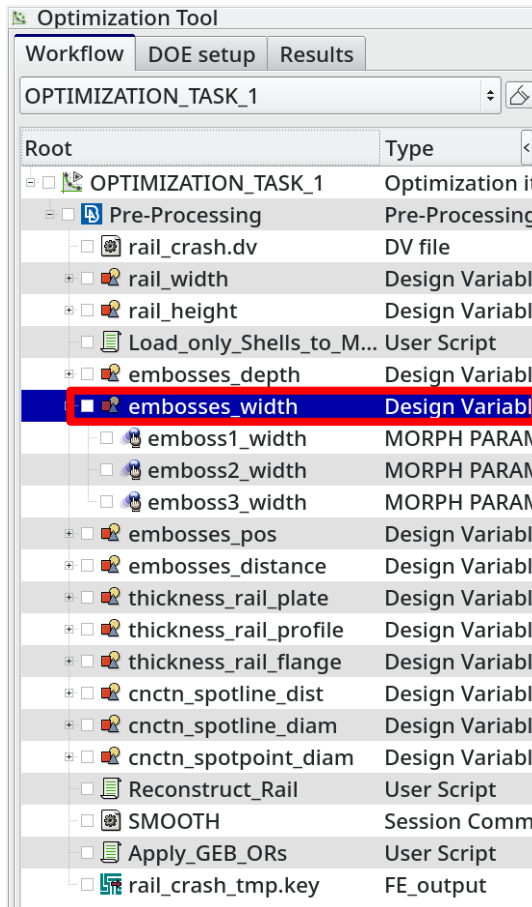

ANSA – Optimization Task

Design Variables → Morphing Parameters

Optimization Tool

Workflow DOE setup Results

OPTIMIZATION_TASK_1

Root	Type
OPTIMIZATION_TASK_1	Optimization it
Pre-Processing	Pre-Processing
rail_crash.dv	DV file
rail_width	Design Variabl
rail_height	Design Variabl
Load_only_Shells_to_M...	User Script
embosses_depth	Design Variabl
embosses_width	Design Variabl
emboss1_width	MORPH PARAM
emboss2_width	MORPH PARAM
emboss3_width	MORPH PARAM
embosses_pos	Design Variabl
embosses_distance	Design Variabl
thickness_rail_plate	Design Variabl
thickness_rail_profile	Design Variabl
thickness_rail_flange	Design Variabl
cnctn_spotline_dist	Design Variabl
cnctn_spotline_diam	Design Variabl
cnctn_spotpoint_diam	Design Variabl
Reconstruct_Rail	User Script
SMOOTH	Session Comm
Apply_GEB_ORs	User Script
rail_crash_tmp.key	FE_output

DESIGN VARIABLE [DESIGN_VARIABLE]

Name **embosses_width**

ID	TYPE	RANGE
3	REAL	BOUNDS
Min Value	Current Value	Max Value
-10.	10.	10.
Comment		

embosses_width

OK Cancel

Assign Parameter to DV

Parameters Select parameter to assign

Value	Id	Name	Used by DV
	10	emboss3_depth_ob	embosses_depth
	11	emboss3_depth unt	embosses depth
	13	emboss1_width	embosses_width
	14	emboss2_width	embosses_width
	15	emboss3_width	embosses_width
	16	embosses_pos	embosses_pos
	17	emboss12_distance	embosses_distance

ANSA – Optimization Task

Design Variables → Morphing Parameters

Shape modification

Design Variable = 10.0

Morphing Parameter

Width of depressions

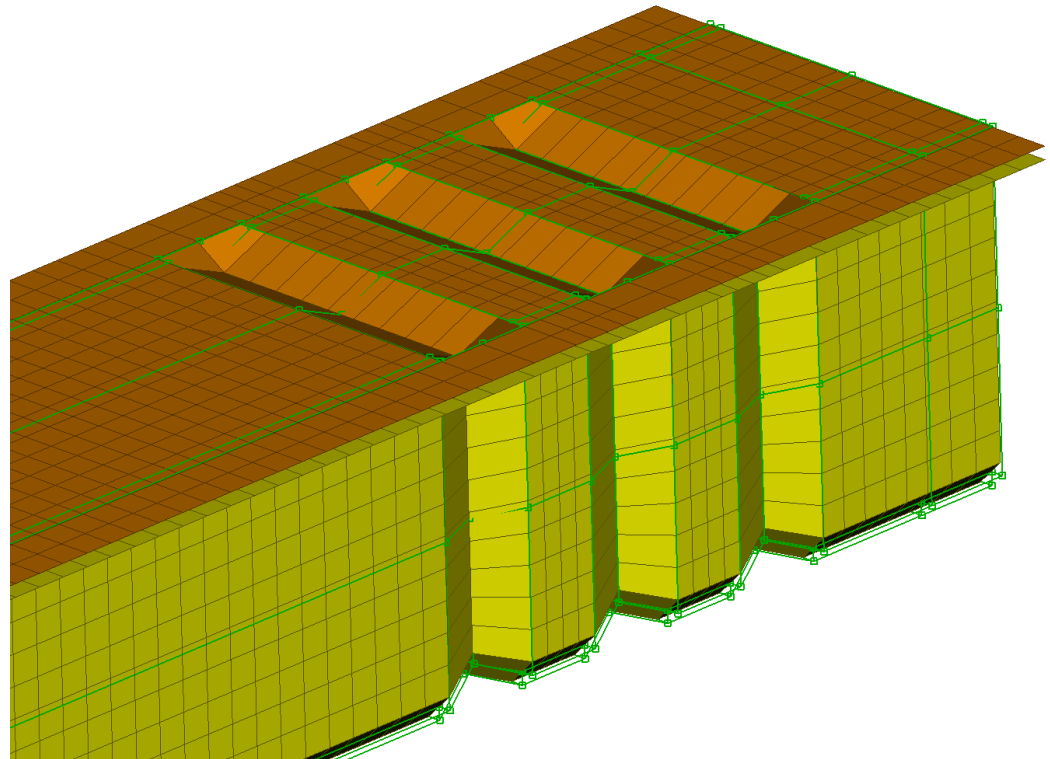

ANSA – Optimization Task

Design Variables → Morphing Parameters

Shape modification

Design Variable = -5.0

Morphing Parameter

Width of depressions

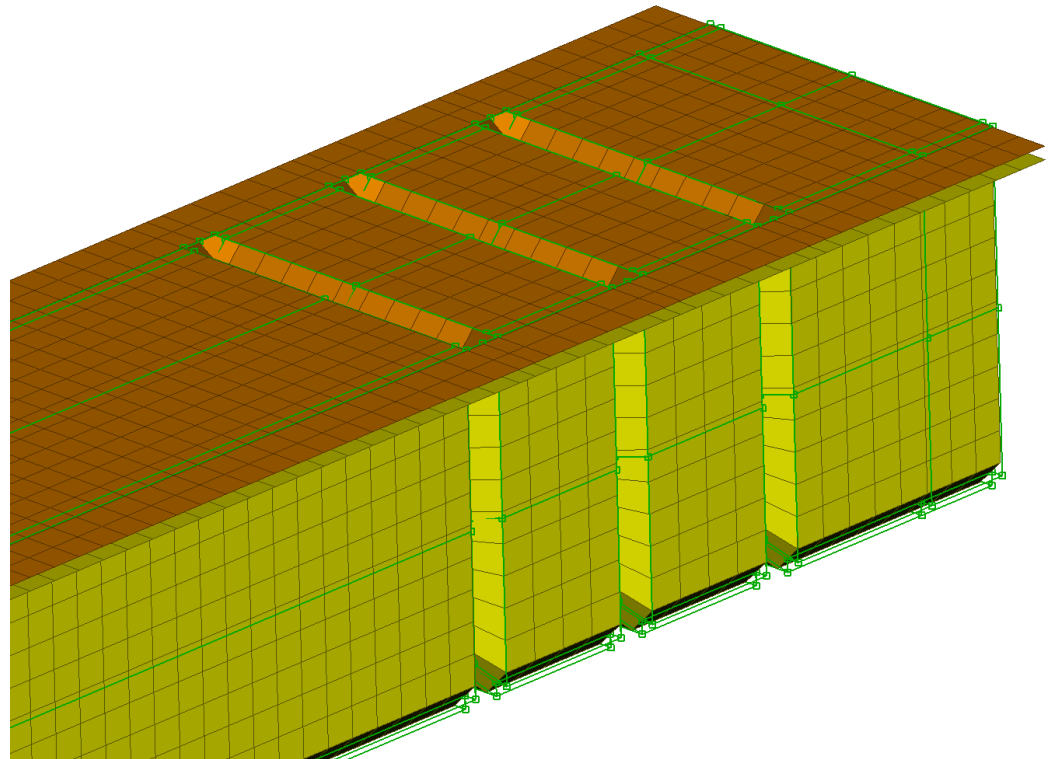

ANSA – Optimization Task

Design Variables → ANSA Parameters

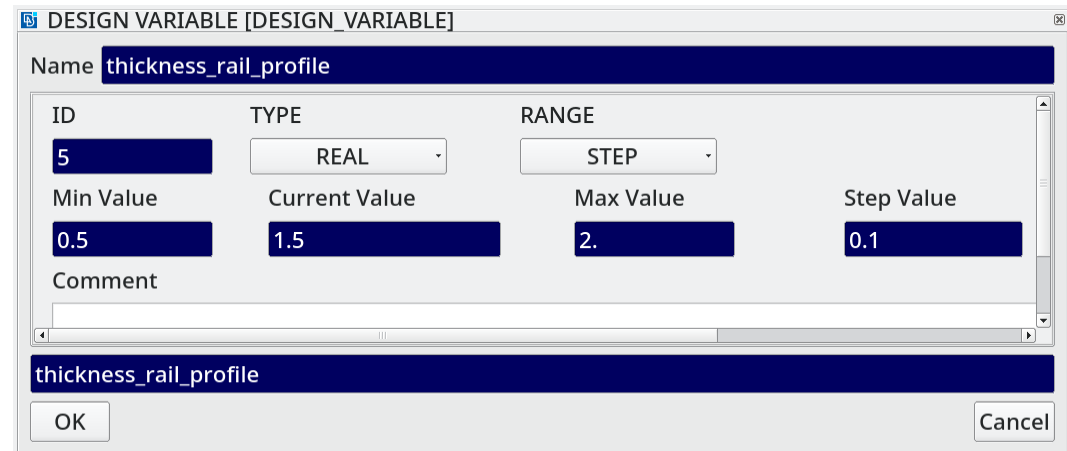
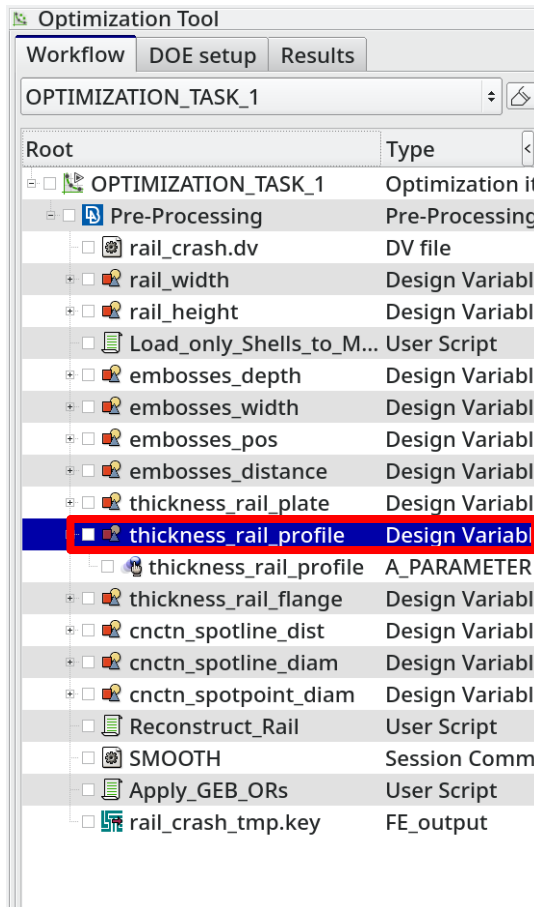

ANSA – Optimization Task

Design Variables → ANSA Parameters

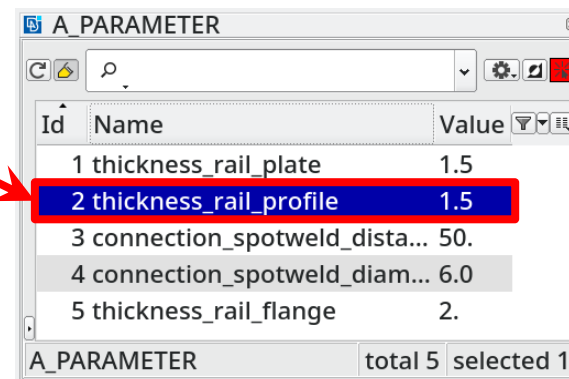
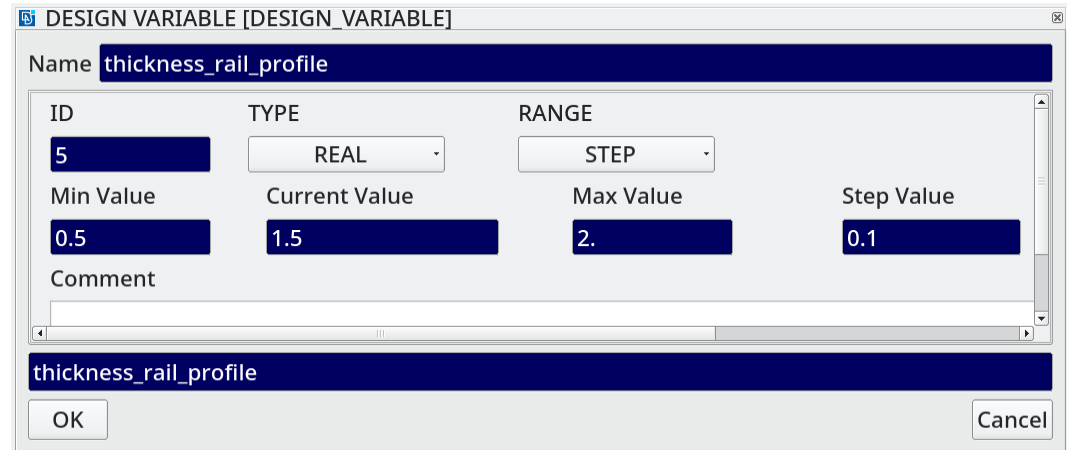
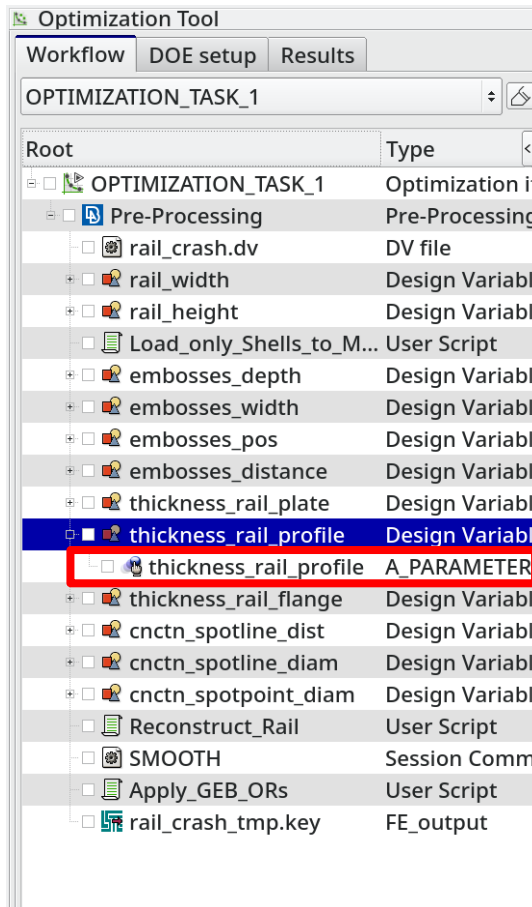

ANSA – Optimization Task

Design Variables → ANSA Parameters

Modification of shell thicknesses, materials, etc.

*PART & *SECTION_SHELL [SECTION_SHELL]

Name: rail_profile

FROZEN_ID: NO, FROZEN_DELETE: NO, DEFINED: YES, TRIM: NO, USE_IN_MODEL: YES

PID	SECID	MID	EOSID	HGID	GRAV	ADPOPT	TMID
3		2		3	0	0	
SECID	ELFORM	SHRF	NIP	PROPT	QR/IRID	QR	ICOMP
	16	1	2	1.0	QR	0.0	0
T1	T2	T3	T4	NLOC	MAREA	IDOF	EDGSET
1.5				0		0	

rail_profile

OK ColorEdit Cancel

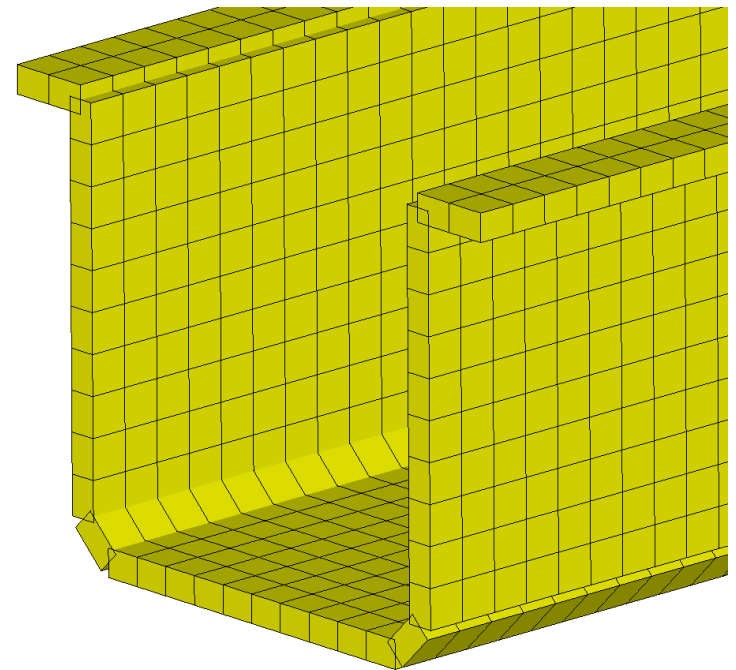

ANSA – Optimization Task

Design Variables → ANSA Parameters

Modification of shell thicknesses, materials, etc.

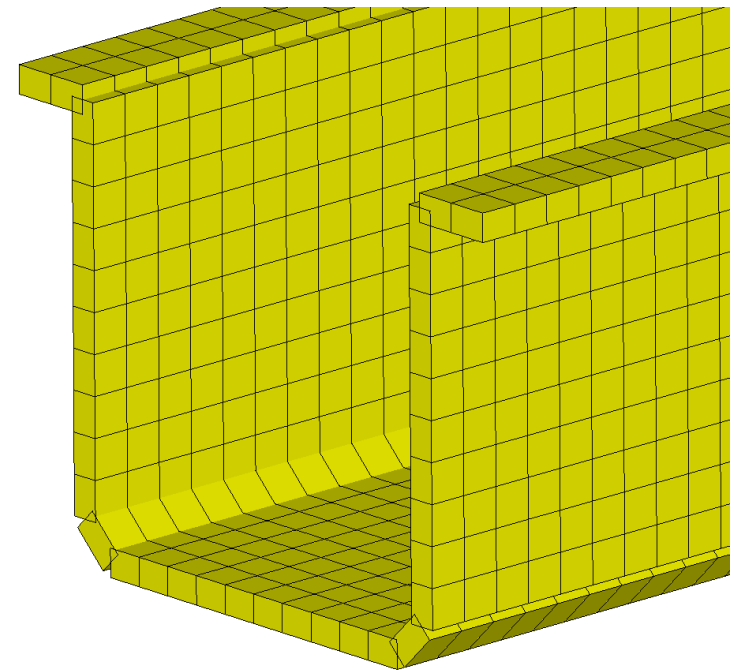
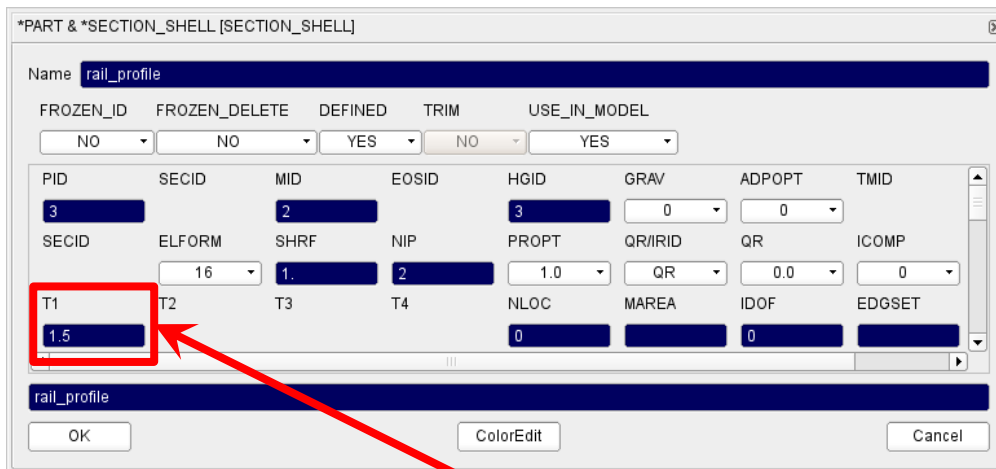

ANSA Parameter

Design Variable = 5.0

ANSA – Optimization Task

Design Variables → ANSA Parameters

Modification of shell thicknesses, materials, etc.

*PART & *SECTION_SHELL [SECTION_SHELL]

Name: rail_profile

FROZEN_ID: NO, FROZEN_DELETE: NO, DEFINED: YES, TRIM: NO, USE_IN_MODEL: YES

PID	SECID	MID	EOSID	HGID	GRAV	ADPOPT	TMID
3		2		3	0	0	
SECID	ELFORM	SHRF	NIP	PROPT	QR/IRID	QR	ICOMP
	16	1	2	1.0	QR	0.0	0
T1	T2	T3	T4	NLOC	MAREA	IDOF	EDGSET
1.5				0		0	

OK ColorEdit Cancel

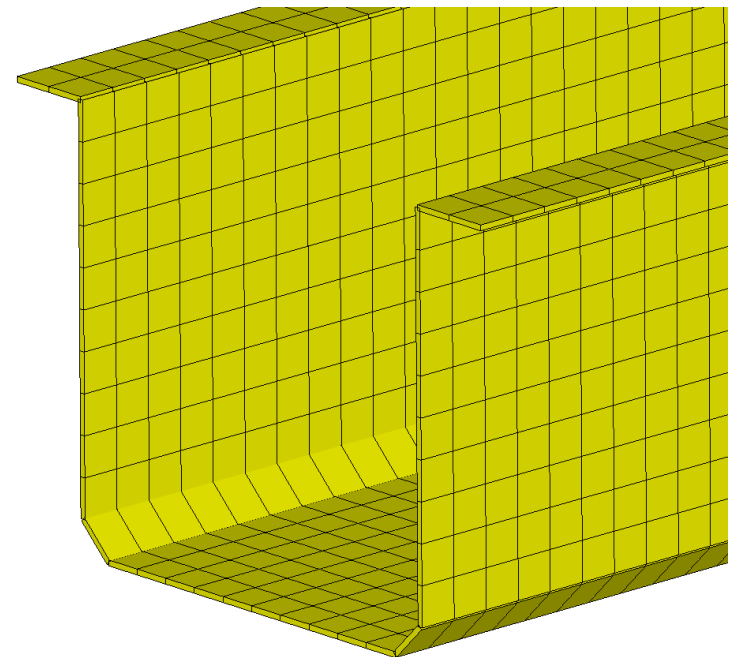

ANSA Parameter

Design Variable = 1.0

ANSA – Optimization Task

Design Variables → ANSA Parameters

Modification of connections (weld spot **distance**, diameter, etc.)

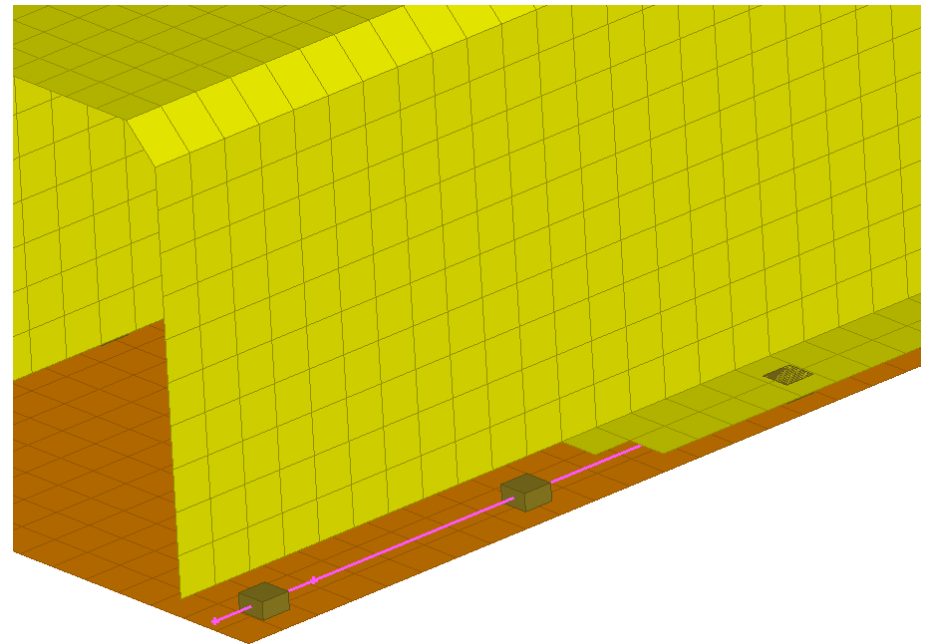
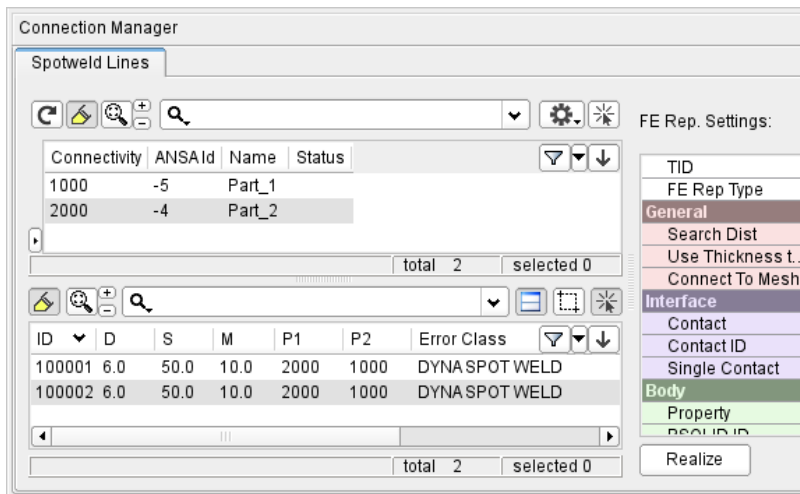

ANSA – Optimization Task

Design Variables → ANSA Parameters

Modification of connections (weld spot distance, diameter, etc.)

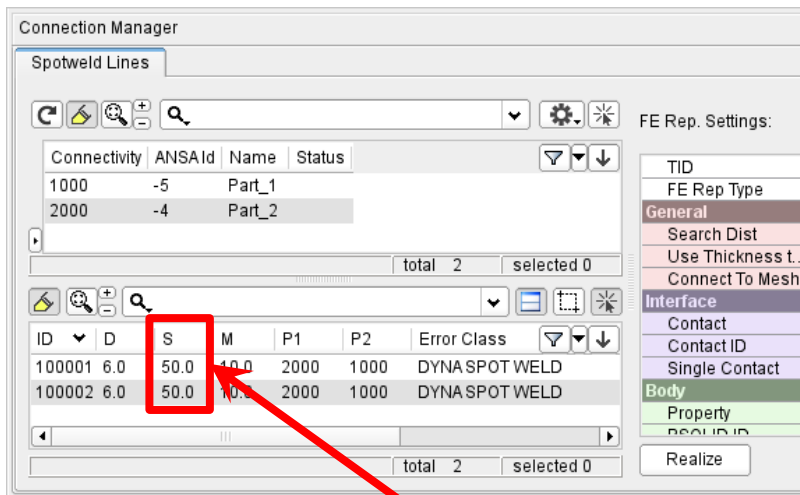

ANSA Parameter

Design Variable (weld spot distance) = 50

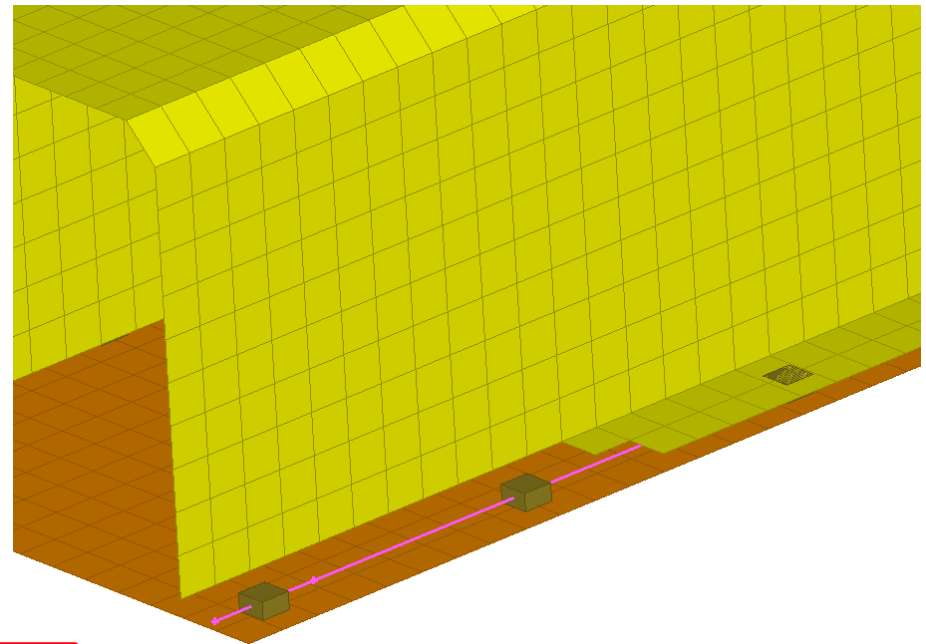

ANSA – Optimization Task

Design Variables → ANSA Parameters

Modification of connections (weld spot distance, diameter, etc.)

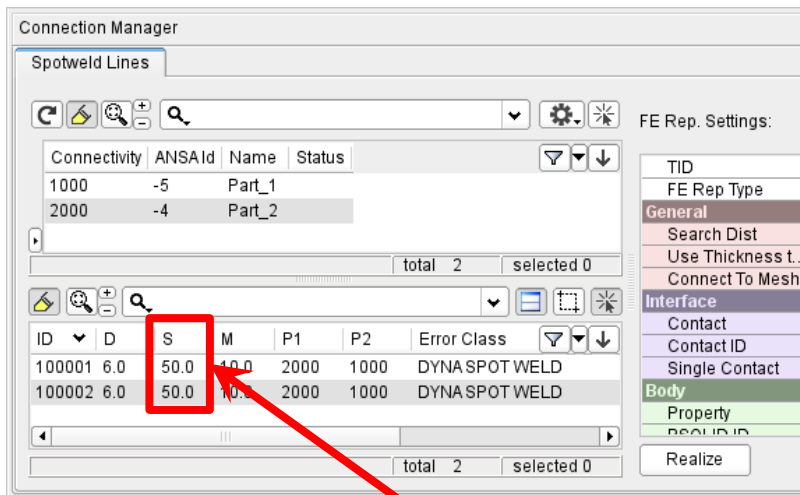

ANSA Parameter

Design Variable (weld spot distance) = 20

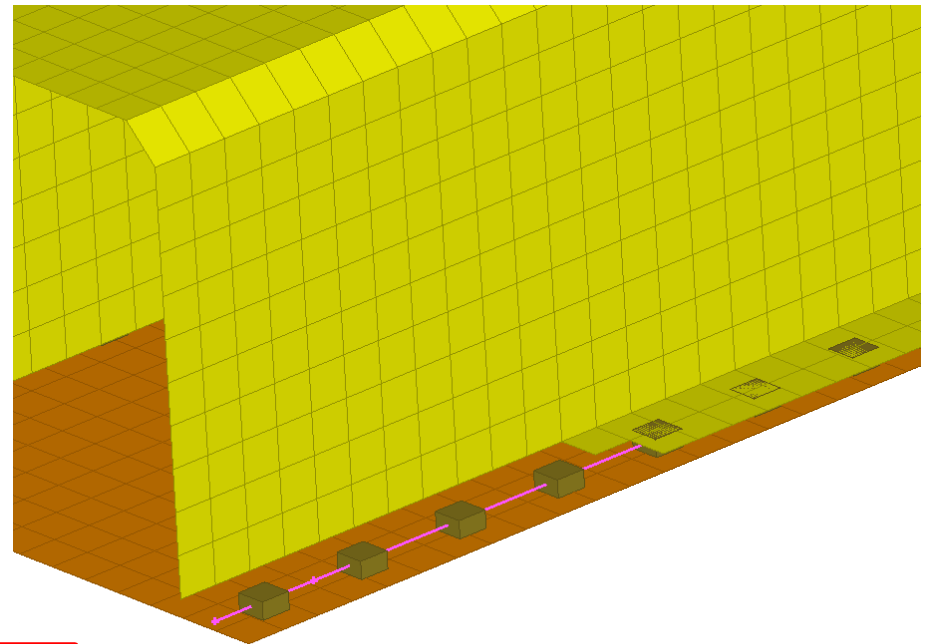

ANSA – Optimization Task

Design Variables → ANSA Parameters

Modification of connections (weld spot distance, diameter, etc.)

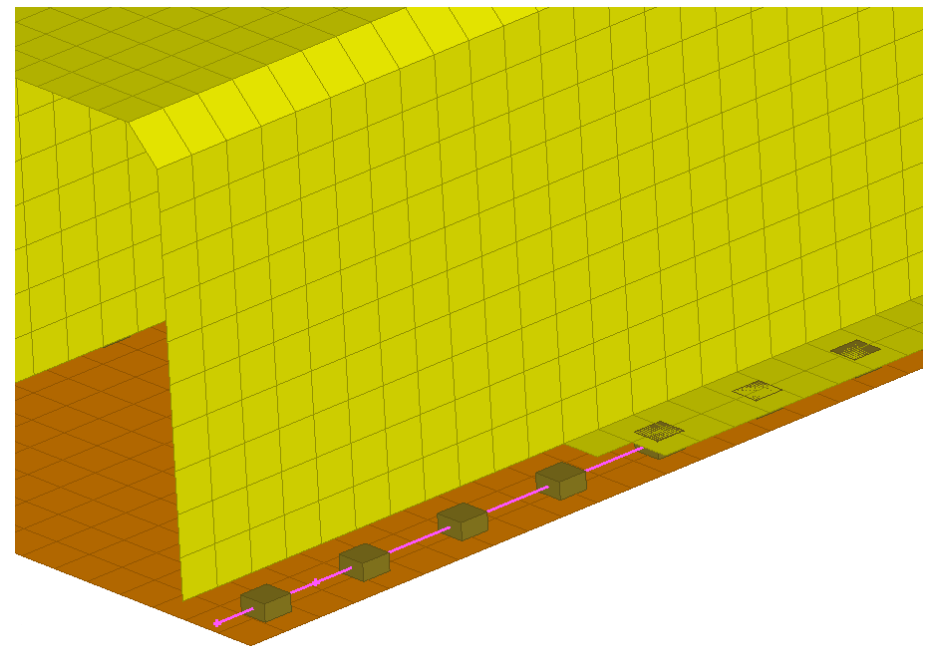
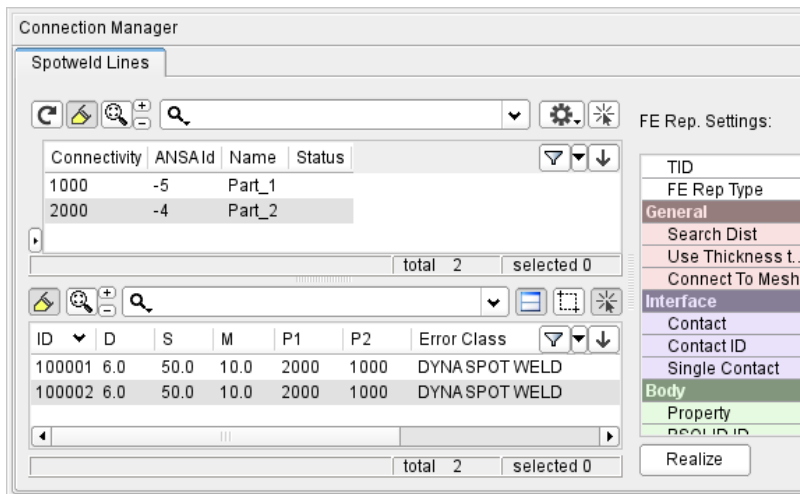

ANSA – Optimization Task

Design Variables → ANSA Parameters

Modification of connections (weld spot distance, diameter, etc.)

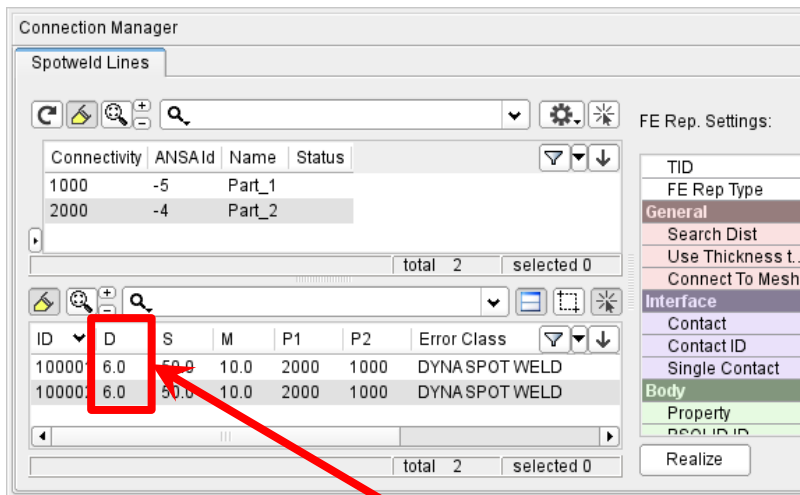

ANSA Parameter

Design Variable (weld spot diameter) = 6.0

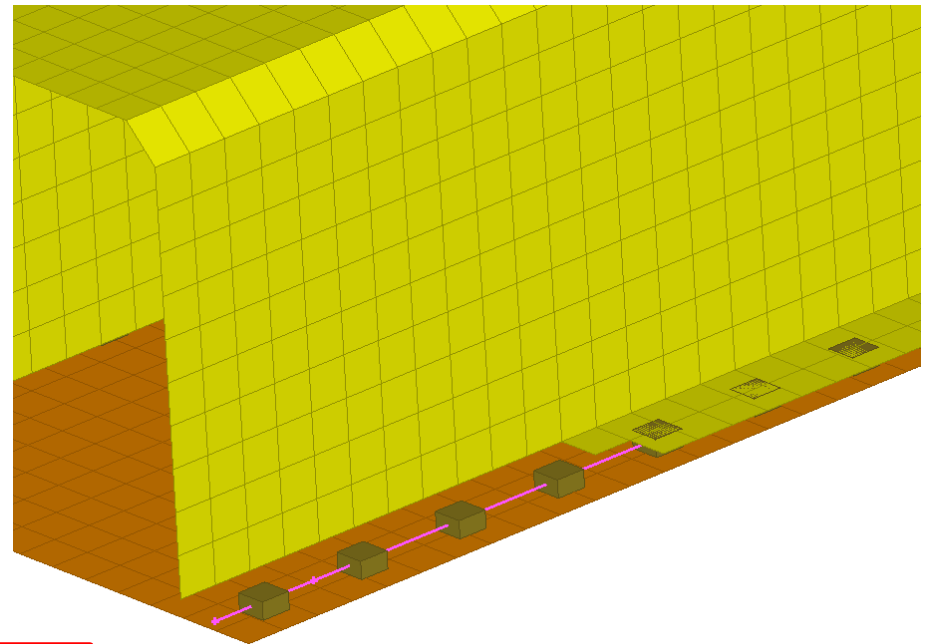

ANSA – Optimization Task

Design Variables → ANSA Parameters

Modification of connections (weld spot distance, diameter, etc.)

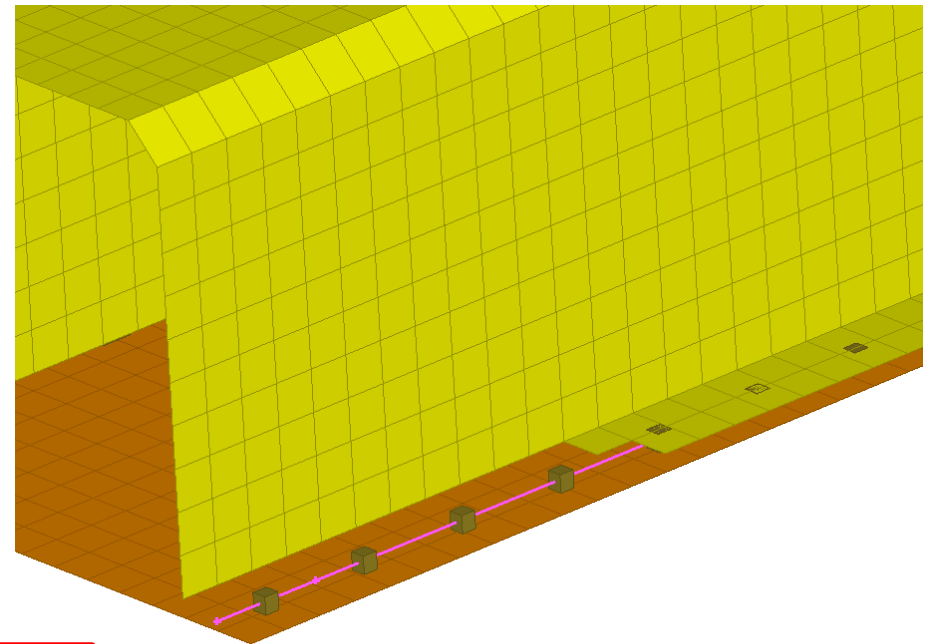
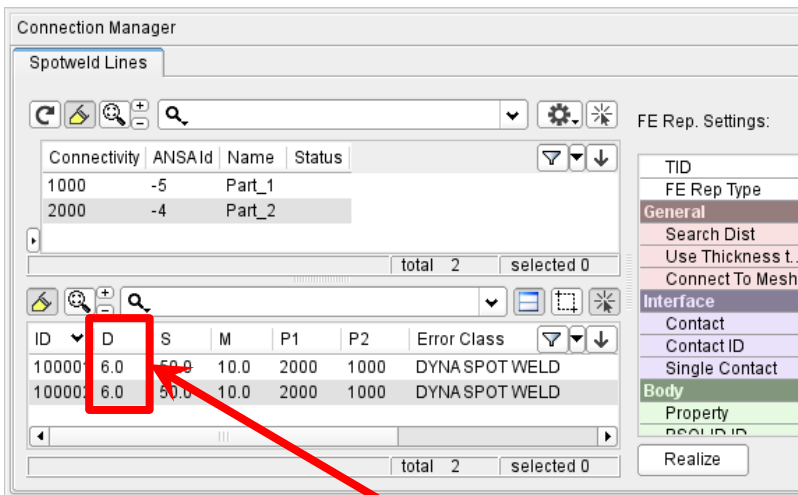

ANSA – Optimization Task

DOE → Simulate

- Checking DV combinations (e.g. Full Factorial) → Model Validity
- Checking Element Criteria

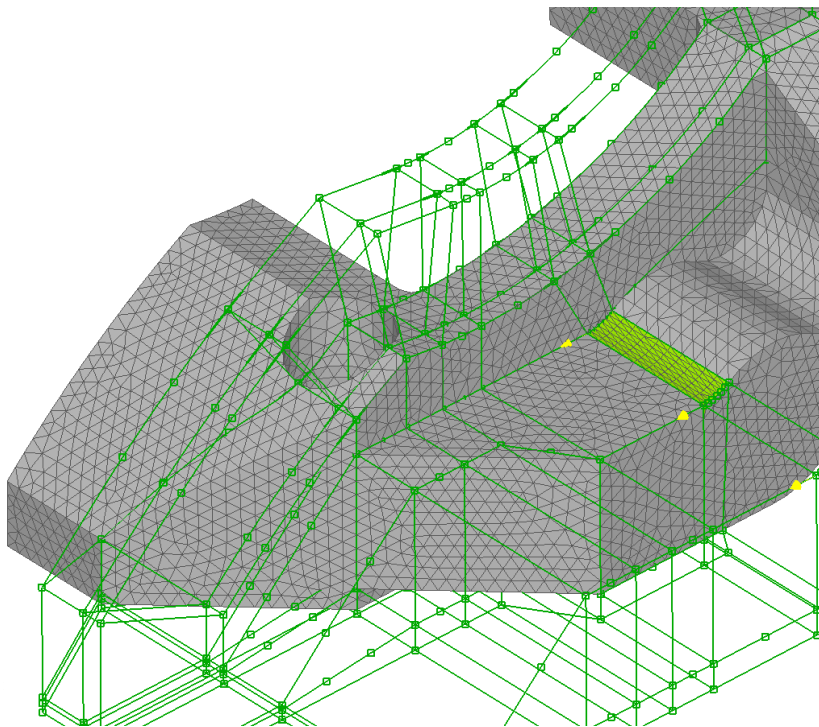

Optimization Tool			
Workflow DOE setup Results			
Design variables			
ID	Name	Min Value	Max Value
3	DV_Hoeh_e_Mittelsteg	-5.	12.
2	DV_Breite_Seitensteg	0	10.
1	DV_Breite_Flachsteg_oben	0.	20.
6	DV_Breite_Flachsteg_unten	0.	25.
9	DV_Hoeh_e_Nase	0.	10.
4	DV_Breite_Mittelsteg_ob_au	-20.	13.
7	DV_Breite_Mittelsteg_ob_in	-20.	13.
5	DV_Breite_Mittelsteg_un_au	-13.	10.
8	DV_Breite_Mittelsteg_un_in	-13.	10.
10	DV_Breite_Nase	0.	20.

Experiments			
	_breite_Seitensteg	_breite_Flachsteg	
1	0.	0.	
2	2.	5.	
3	4.	10.	
4	6.	15.	
5	8.	20.	
6	10.	25.	

ANSA – Optimization Task

DOE → Simulate

- Checking DV combinations (e.g. Full Factorial) → Model Validity
- Checking Element Criteria

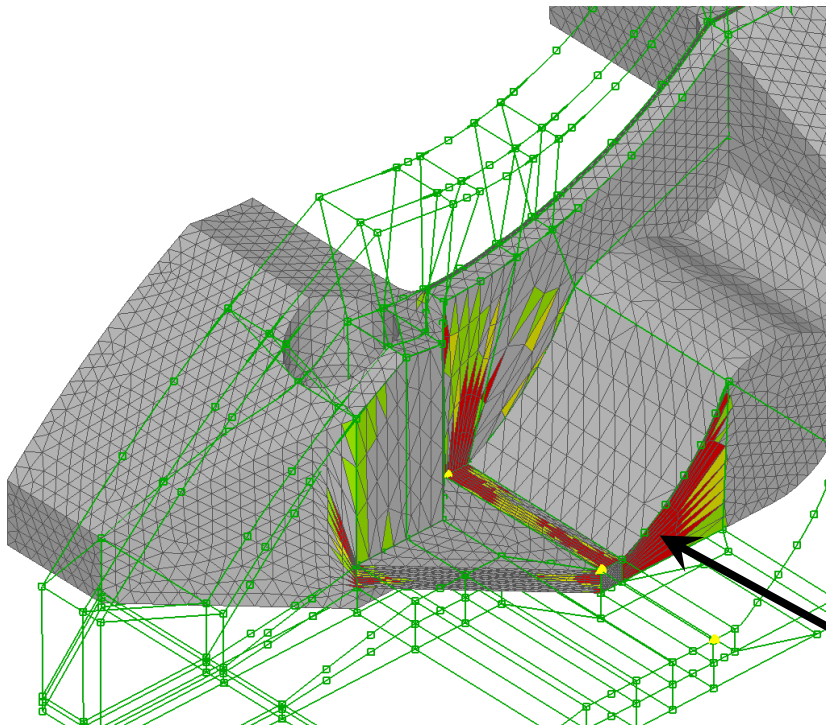

Optimization Tool				Experiments		
Workflow DOE setup Results						
Design variables						
ID	Name	Min Value	Max Value			
3	DV_Hoeh_e_Mittelsteg	-5.	12.	1	0.	0.
2	DV_Breite_Seitensteg	0	10.	2	2.	5.
1	DV_Breite_Flachsteg_oben	0.	20.	3	4.	10.
6	DV_Breite_Flachsteg_unten	0.	25.	4	6.	15.
9	DV_Hoeh_e_Nase	0.	10.	5	8.	20.
4	DV_Breite_Mittelsteg_ob_au	-20.	13.	6	10.	25.
7	DV_Breite_Mittelsteg_ob_in	-20.	13.			
5	DV_Breite_Mittelsteg_un_au	-13.	10.			
8	DV_Breite_Mittelsteg_un_in	-13.	10.			
10	DV_Breite_Nase	0.	20.			

Failed elements

ANSA – Optimization Task

User Scripts / User Actions

For improving mesh quality

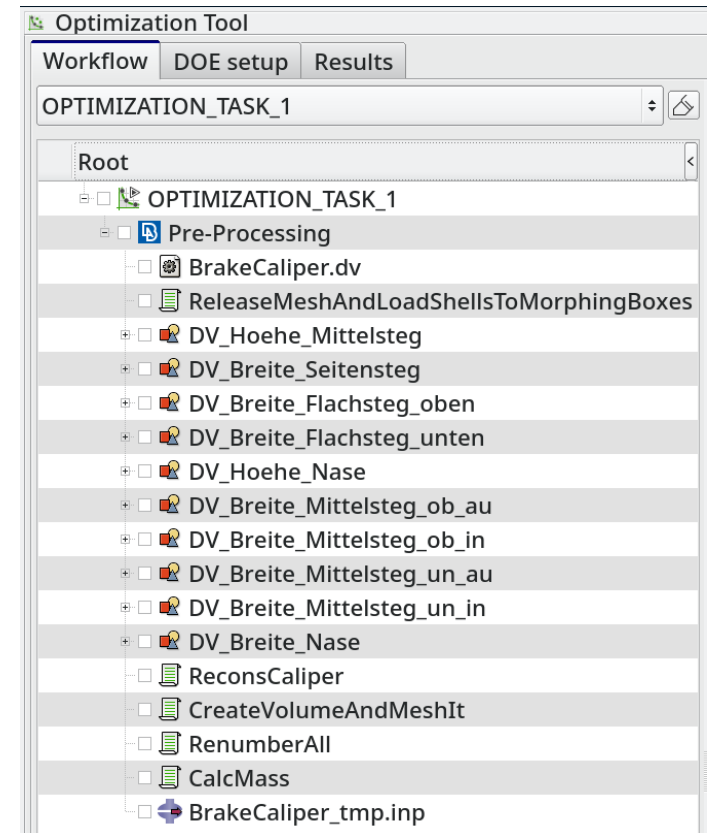
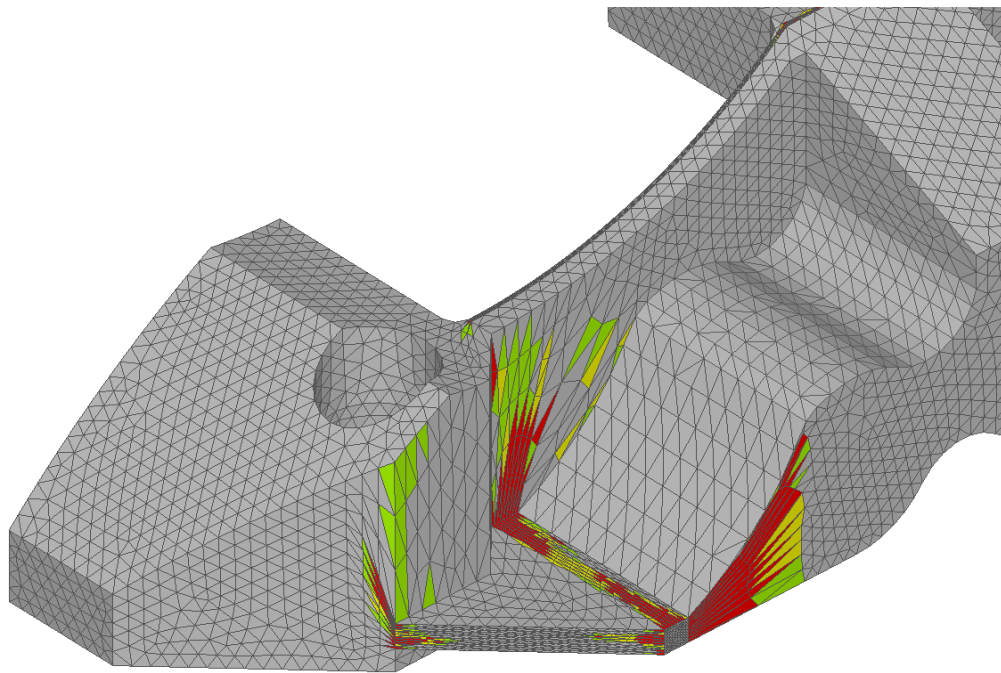

ANSA – Optimization Task

User Scripts / User Actions

For improving mesh quality

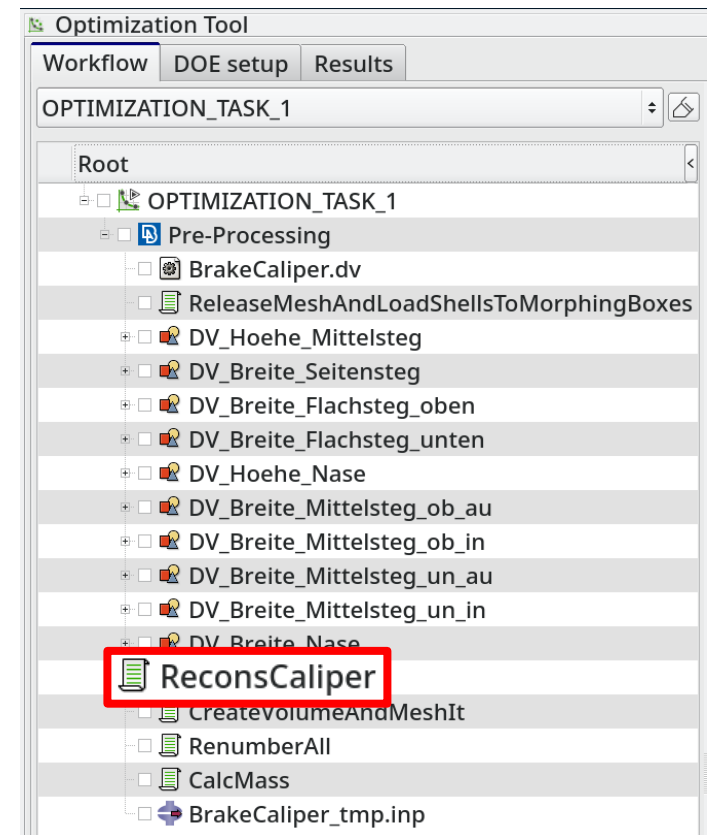
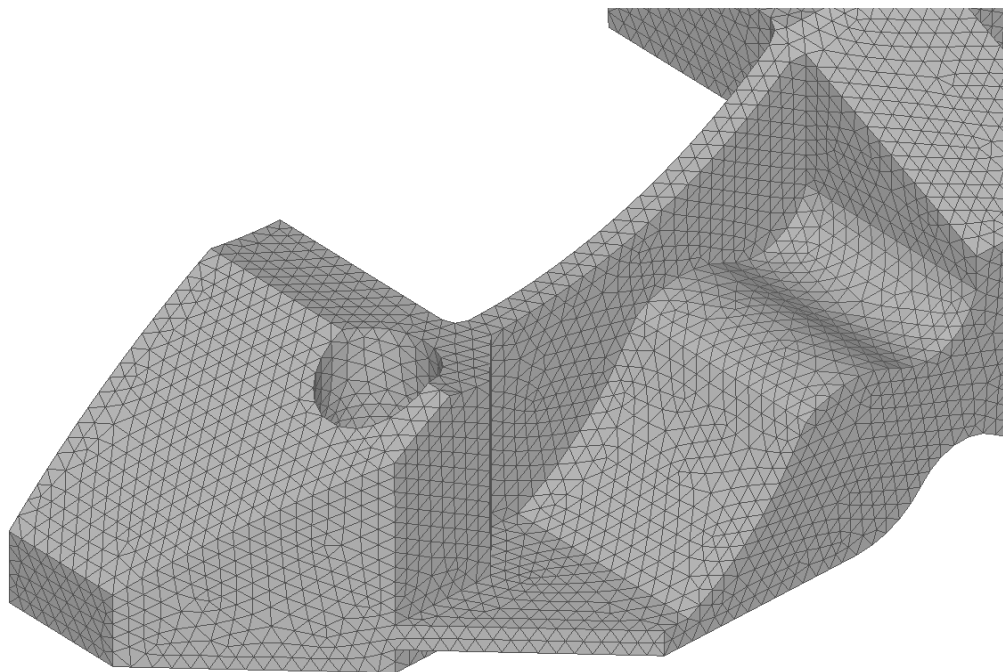

ANSA – Optimization Task

User Scripts / User Actions

For creating Volume Mesh, Renumber, ...

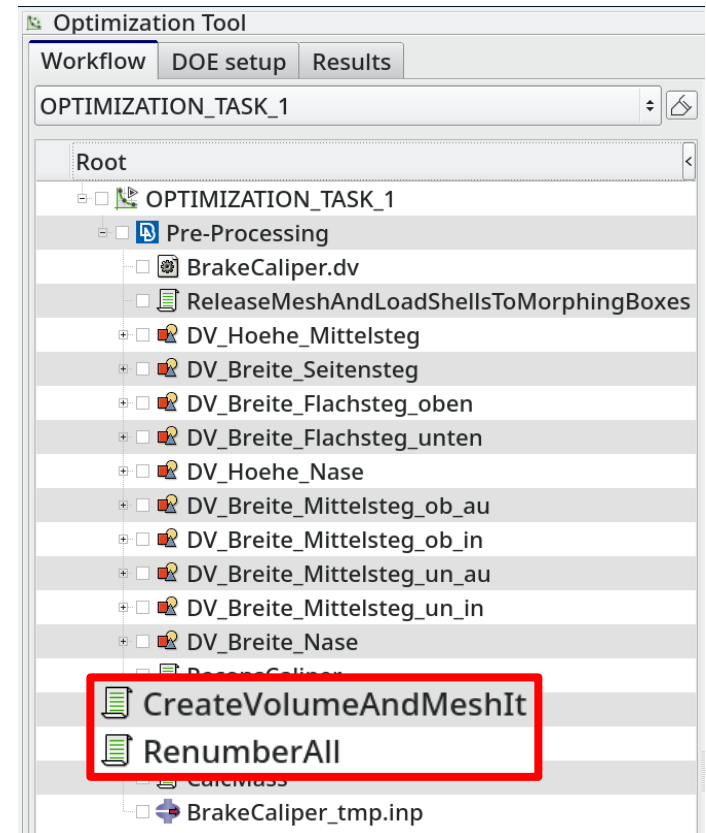
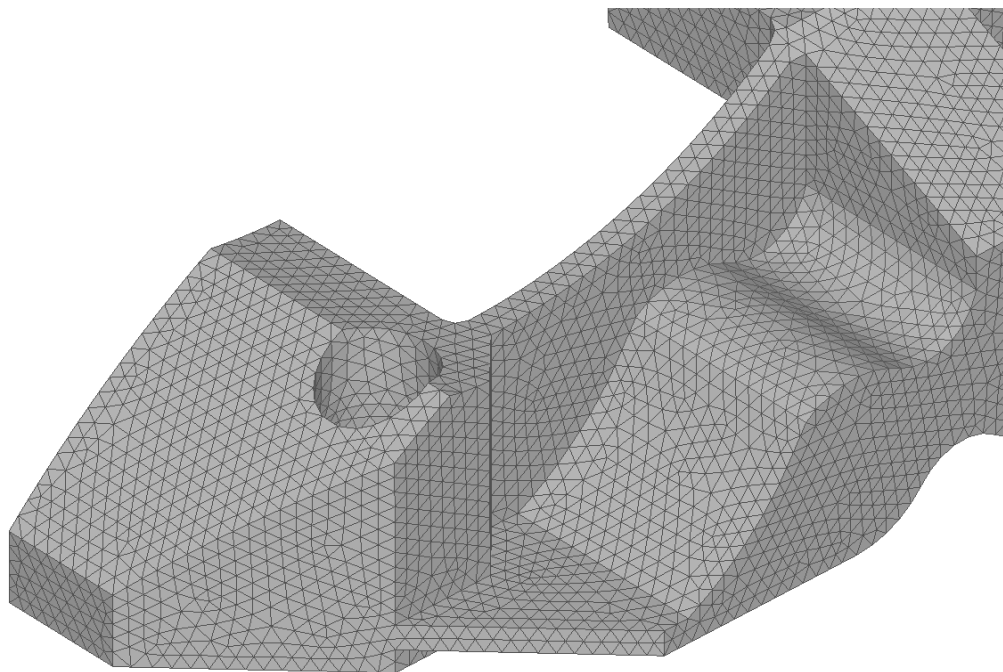

ANSA – Optimization Task Responses

From card values or measurements (e.g. mass, distances after morphing)

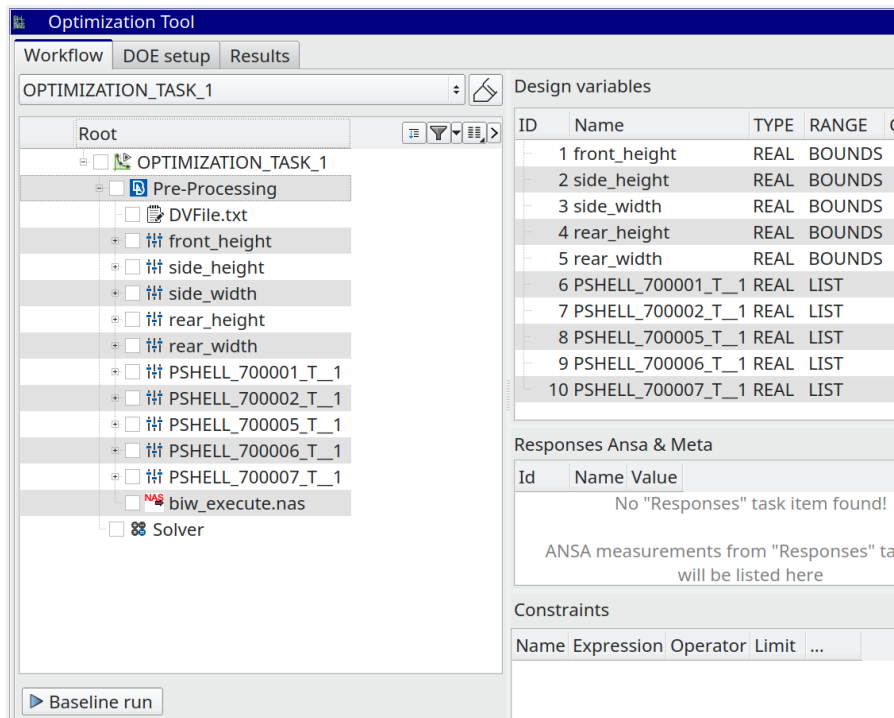

The screenshot shows the Optimization Tool interface with the following components:

- Workflow:** Workflow, DOE setup, Results
- Task Name:** OPTIMIZATION_TASK_1
- Design variables table:**

ID	Name	TYPE	RANGE	C
1	front_height	REAL	BOUNDS	
2	side_height	REAL	BOUNDS	
3	side_width	REAL	BOUNDS	
4	rear_height	REAL	BOUNDS	
5	rear_width	REAL	BOUNDS	
6	PSHELL_700001_T_1	REAL	LIST	
7	PSHELL_700002_T_1	REAL	LIST	
8	PSHELL_700005_T_1	REAL	LIST	
9	PSHELL_700006_T_1	REAL	LIST	
10	PSHELL_700007_T_1	REAL	LIST	
- Responses Ansa & Meta:**

Id	Name	Value
No "Responses" task item found!		
ANSA measurements from "Responses" ta: will be listed here		
- Constraints:**

Name	Expression	Operator	Limit	...
- Buttons:** Baseline run

ANSA – Optimization Task Responses

From card values or measurements (e.g. mass, distances after morphing)

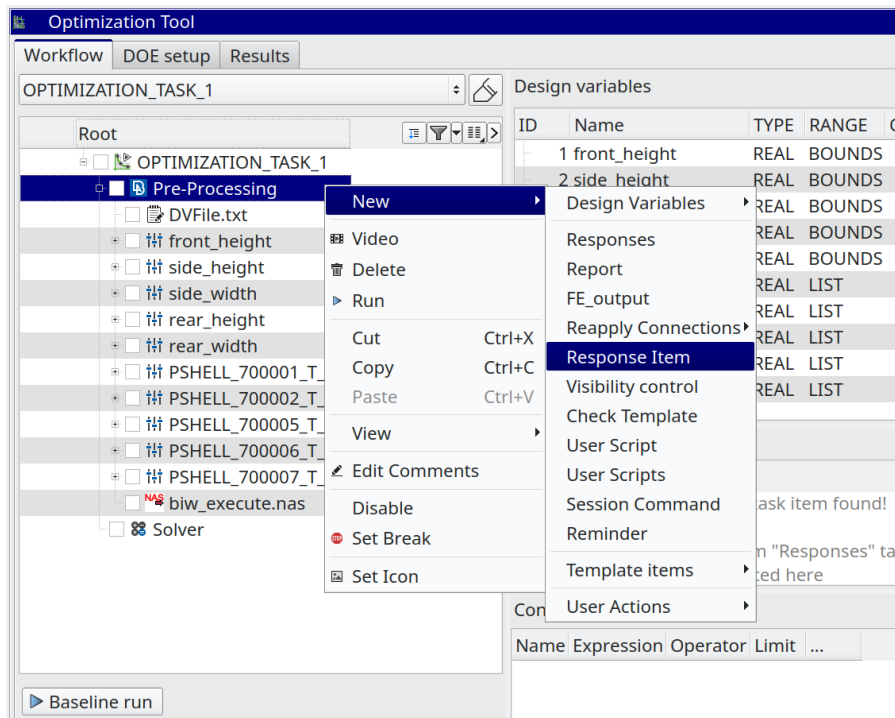

ANSA – Optimization Task

Responses

From card values or measurements (e.g. mass, distances after morphing)

The screenshot displays the ANSA Optimization Tool interface. The left pane shows a tree view of the optimization task 'OPTIMIZATION_TASK_1' with various design variables and responses. The right pane shows the 'Design variables' table and the 'Responses Ansa & Meta' table.

ID	Name	TYPE	RANGE	C
1	front_height	REAL	BOUNDS	
2	side_height	REAL	BOUNDS	
3	side_width	REAL	BOUNDS	
4	rear_height	REAL	BOUNDS	
5	rear_width	REAL	BOUNDS	
6	PSHELL_700001_T_1	REAL	LIST	
7	PSHELL_700002_T_1	REAL	LIST	
8	PSHELL_700005_T_1	REAL	LIST	
9	PSHELL_700006_T_1	REAL	LIST	
10	PSHELL_700007_T_1	REAL	LIST	

Id	Name	Value
1	MEASUREMENT_1_RESULT	72.6283
2	MEASUREMENT_2_RESULT	0.0025

ANSA – Optimization Task

Responses

From card values or measurements (e.g. mass, distances after morphing)

Optimization Tool

Workflow: DOE setup Results

OPTIMIZATION_TASK_1

Design variables

ID	Name	TYPE	RANGE	C
1	front_height	REAL	BOUNDS	
2	side_height	REAL	BOUNDS	
3	side_width	REAL	BOUNDS	
4	rear_height	REAL	BOUNDS	
5	rear_width	REAL	BOUNDS	
6	PSHELL_700001_T_1	REAL	LIST	
7	PSHELL_700002_T_1	REAL	LIST	
8	PSHELL_700005_T_1	REAL	LIST	
9	PSHELL_700006_T_1	REAL	LIST	
10	PSHELL_700007_T_1	REAL	LIST	

Responses Ansa & Meta

Id	Name	Value
1	MEASUREMENT_1_RESULT	72.6283
2	MEASUREMENT_2_RESULT	0.0025

Constraints

Name Expression Operator Limit ...

Baseline run

```
# RESPONSES
#-----
# Id | Name | Value
#-----
1 , MEASUREMENT_1_RESULT, 72.62835287236592
2 , MEASUREMENT_2_RESULT, 0.002545587278319321
#-----
#
```

Correctly formatted for
import in LS-OPT

META – OptimizerSetup Toolbar

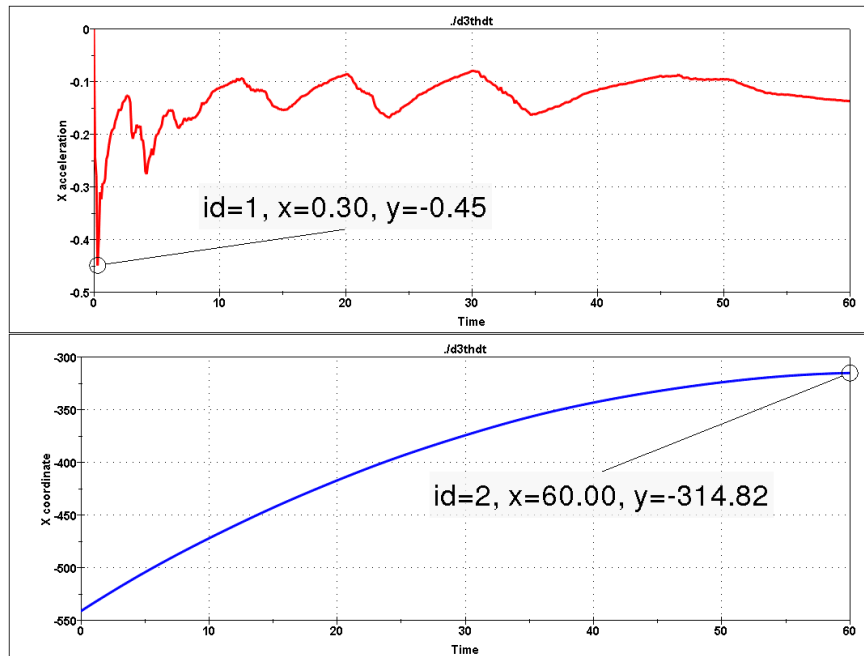

The screenshot shows the 'OptimizerSetup' dialog box. It is divided into two main sections: 'Response Variables' and 'History Variables'.
 Under 'Response Variables', there is a dropdown menu currently showing '1 acceleration'. Below it are buttons for 'Add', 'Print Response Values', 'Update Response Values' (with 'Current' and 'All' sub-buttons), 'Remove' (with 'Current' and 'All' sub-buttons), and 'Rename Response' (with a text input field and a dropdown arrow).
 Under 'History Variables', there is a dropdown menu currently showing an empty field. Below it are buttons for 'Add', 'Print History Values', 'Update History Values' (with 'Current' and 'All' sub-buttons), 'Remove' (with 'Current' and 'All' sub-buttons), and 'Rename History' (with a text input field and a dropdown arrow).
 At the bottom of the dialog is a button labeled 'Export Session'.

META – OptimizerSetup Toolbar

- Responses from annotations, variables, advanced expressions

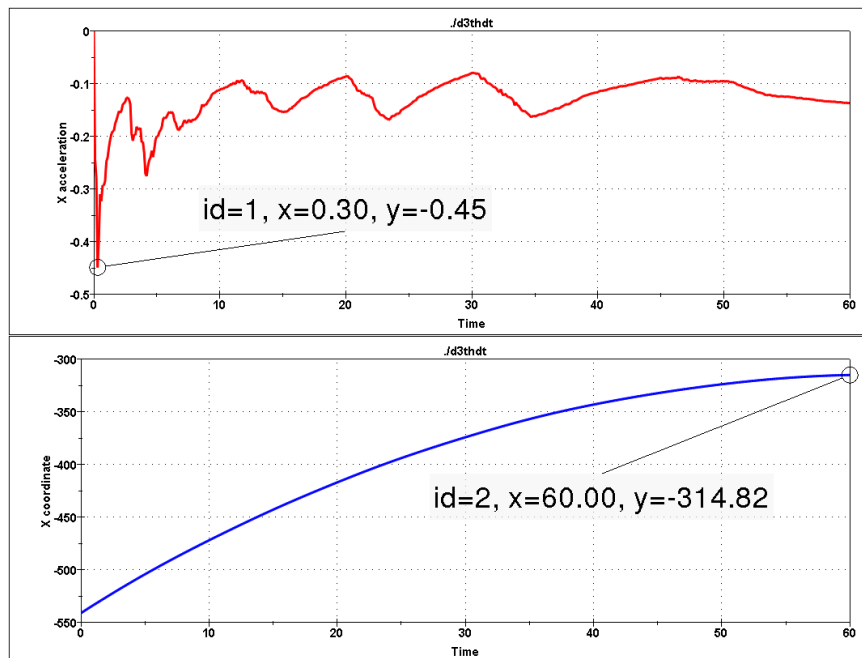

The screenshot shows the 'OptimizerSetup' dialog box. The 'Response Variables' section is active, showing '1 acceleration' selected. A context menu is open over the 'Add' button, listing the following options: 'Pick Annotations', 'Selected Annotations', 'Annotation List', 'From Variable Name', and 'From Advanced Expression'. Other buttons in the toolbar include 'Print Response Values', 'Update Response Values', 'Remove', 'Rename Response', 'History Variables', 'Print History Values', 'Update History Values', 'Remove', 'Rename History', and 'Export Session'.

META – OptimizerSetup Toolbar

- Responses from annotations, variables, advanced expressions
- Histories from 2D plot curves

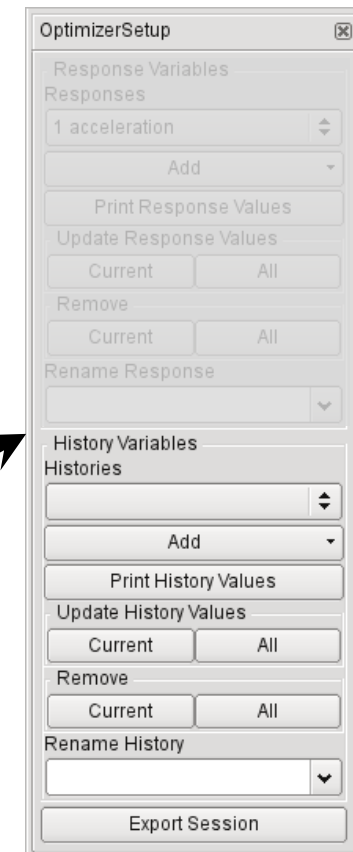
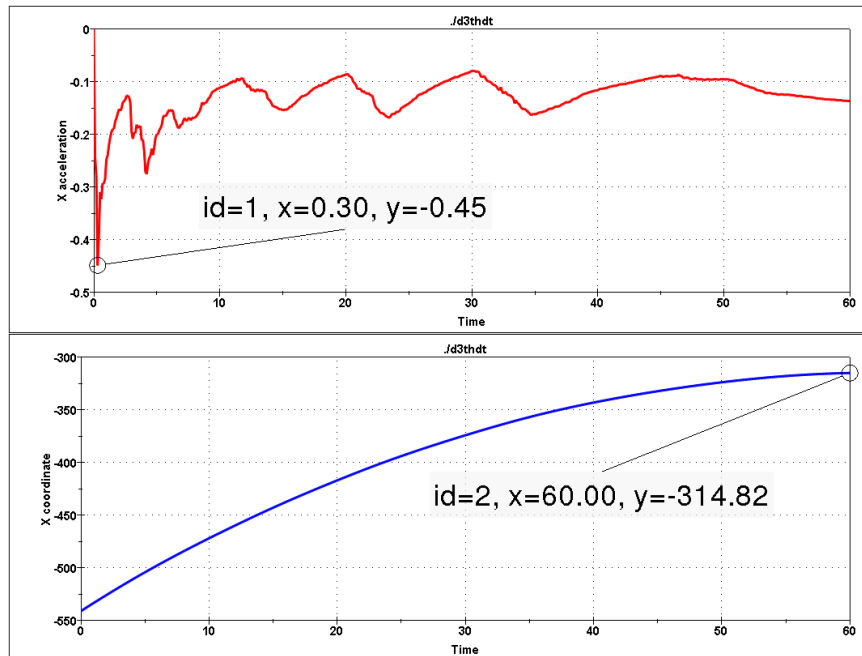

META – OptimizerSetup Toolbar

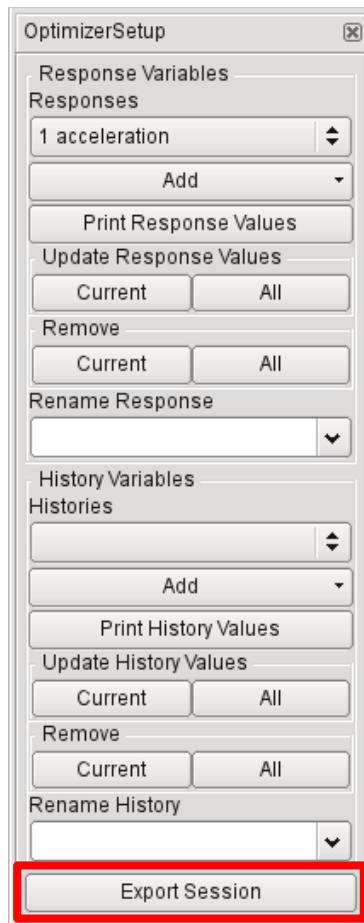

Exports:

- Session file (for reproduction of results extraction)
- Output file, containing responses and histories

```
#OptimizerSetup Response & history File created by META post  
RESPONSES  
1, acceleration, -1.18  
2, intrusion, -440.07  
END
```

Correctly formatted for
import in LS-OPT

Connecting ANSA to LS-OPT

Stage for ANSA

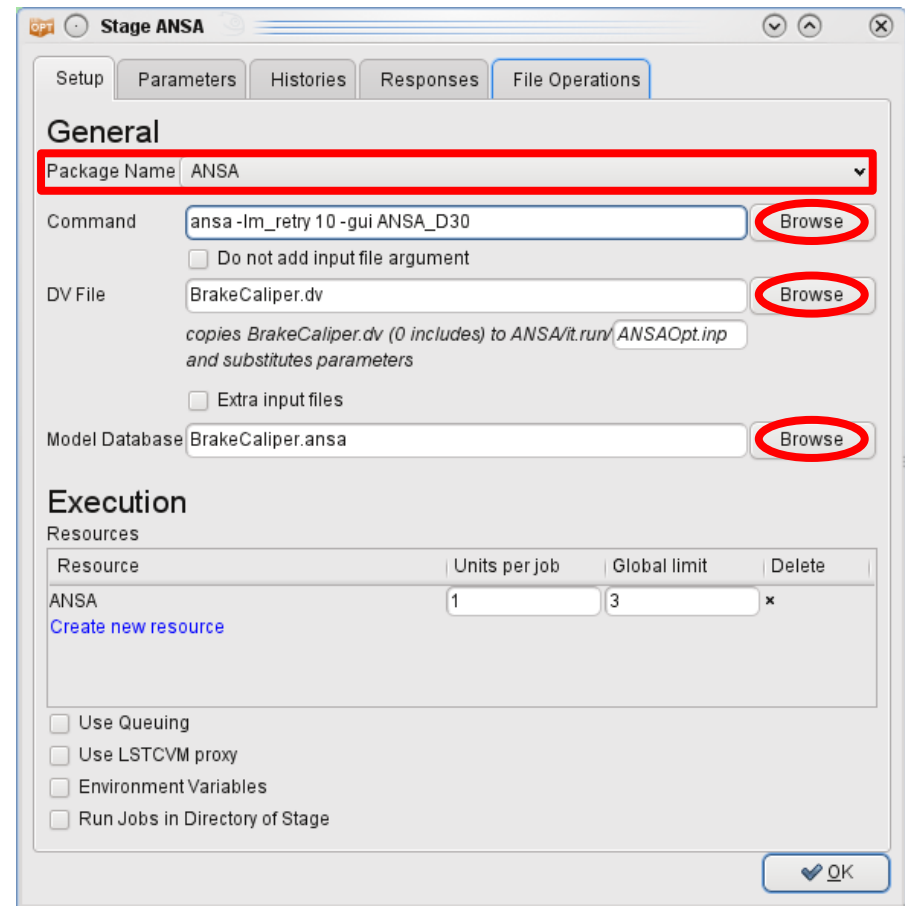
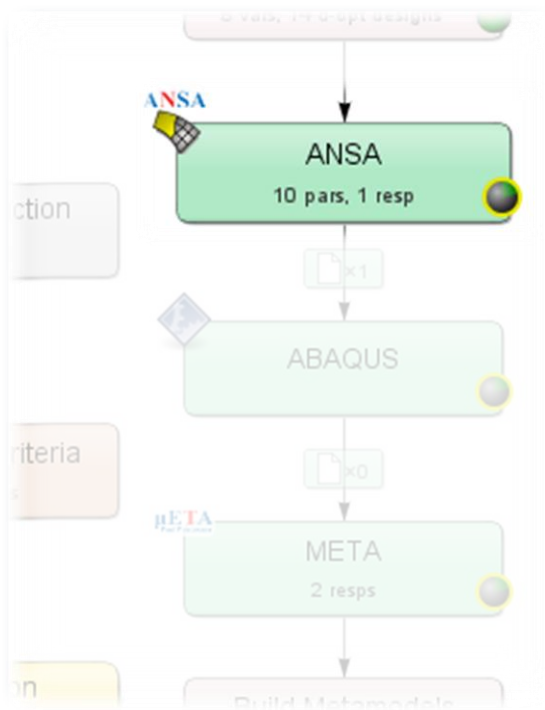

Connecting ANSA to LS-OPT

ANSA → DV file → Design Variables in LS-OPT

```
#
# ANSA_VERSION: 15.0.1
#
# file created by ANSA Fri Feb 14 15:49:00 2014
#
# Output from:
# ansaout.ansa
#
# DESIGN VARIABLES
#-----
# ID | DESIGN VARIABLE NAME | TYPE | RANGE | CURRENT VA
#-----
3, DV_Hoehe_Mittelsteg, REAL, BOUNDS, 0., -5.
2, DV_Breite_Seitensteg, REAL, BOUNDS, 0., -5.
1, DV_Breite_Flachsteg_oben, REAL, BOUNDS, 0.,
6, DV_Breite_Flachsteg_unten, REAL, BOUNDS,
9, DV_Hoehe_Nase, REAL, BOUNDS, 0., 0., 10.
4, DV_Breite_Mittelsteg_ob_au, REAL, BOUNDS,
7, DV_Breite_Mittelsteg_ob_in, REAL, BOUNDS,
5, DV_Breite_Mittelsteg_un_au, REAL, BOUNDS,
8, DV_Breite_Mittelsteg_un_in, REAL, BOUNDS,
10, DV_Breite_Nase, REAL, BOUNDS, 0., 0., 20.
#-----
```

Parameter Setup | Stage Matrix | Sampling Matrix | Resources | Features

Show advanced options

Type	Name	Starting	Init. Range	Minimum	Maximum
Continuous	DV_Breite_Flachsteg_oben	0		0	15
Continuous	DV_Breite_Flachsteg_unten	0		0	25
Continuous	DV_Breite_Mittelsteg_ob_au	0		0	13
Continuous	DV_Breite_Mittelsteg_ob_in	10		-20	13
Continuous	DV_Breite_Mittelsteg_un_au	0		0	10
Continuous	DV_Breite_Mittelsteg_un_in	5		-13	10
Continuous	DV_Breite_Nase	0		0	20
Continuous	DV_Breite_Seitensteg	0		-5	10
Continuous	DV_Hoehe_Mittelsteg	0		-5	12
Continuous	DV_Hoehe_Nase	0		0	10

Add...

OK

Connecting ANSA to LS-OPT

Fine Tuning of Design Variables, e.g.

Type	Name	Starting	Init. Range	Minimum	Maximum
Continuous	DV_Breite_Flachsteg_oben	0	8	0	15
Continuous	DV_Breite_Flachsteg_unten	0	12	0	25
Continuous	DV_Breite_Mittelsteg_ob_au	0	6	0	13
Dependent	DV_Breite_Mittelsteg_ob_in	Definition: DV_Breite_Mittelsteg_ob_au			
Continuous	DV_Breite_Mittelsteg_un_au	0	5	0	10
Dependent	DV_Breite_Mittelsteg_un_in	Definition: DV_Breite_Mittelsteg_un_au			
Continuous	DV_Breite_Nase	0	10	0	20
Continuous	DV_Breite_Seitensteg	0	8	-5	10
Continuous	DV_Hoehe_Mittelsteg	0	8	-5	12
Continuous	DV_Hoehe_Nase	0	5	0	10

OK

Connecting ANSA to LS-OPT

Fine Tuning of Design Variables, e.g.

- Ranges

The screenshot shows the 'Parameter Setup' dialog box in LS-OPT. The 'Show advanced options' checkbox is checked. The dialog displays a table of design variables with their types, names, starting values, initial ranges, and minimum/maximum values. Several initial range values are highlighted with red boxes.

Type	Name	Starting	Init. Range	Minimum	Maximum
Continuous	DV_Breite_Flachsteg_oben	0	8	0	15
Continuous	DV_Breite_Flachsteg_unten	0	12	0	25
Continuous	DV_Breite_Mittelsteg_ob_au	0	6	0	13
Dependent	DV_Breite_Mittelsteg_ob_in	Definition: DV_Breite_Mittelsteg_ob_au			
Continuous	DV_Breite_Mittelsteg_un_au	0	5	0	10
Dependent	DV_Breite_Mittelsteg_un_in	Definition: DV_Breite_Mittelsteg_un_au			
Continuous	DV_Breite_Nase	0	10	0	20
Continuous	DV_Breite_Seitensteg	0	8	-5	10
Continuous	DV_Hoehe_Mittelsteg	0	8	-5	12
Continuous	DV_Hoehe_Nase	0	5	0	10

At the bottom right of the dialog, there is an 'OK' button with a checkmark icon.

Connecting ANSA to LS-OPT

Fine Tuning of Design Variables, e.g.

- Ranges
- Dependencies
- etc.

Parameter Setup | Stage Matrix | Sampling Matrix | Resources | Features

Show advanced options

Type	Name	Starting	Init. Range	Minimum	Maximum
Continuous	DV_Breite_Flachsteg_oben	0	8	0	15
Continuous	DV_Breite_Flachsteg_unten	0	12	0	25
Continuous	DV_Breite_Mittelsteg_ob_au	0	6	0	13
Dependent	DV_Breite_Mittelsteg_ob_in	Definition: DV_Breite_Mittelsteg_ob_au			
Continuous	DV_Breite_Mittelsteg_un_au	0	5	0	10
Dependent	DV_Breite_Mittelsteg_un_in	Definition: DV_Breite_Mittelsteg_un_au			
Continuous	DV_Breite_Nase	0	10	0	20
Continuous	DV_Breite_Seitensteg	0	8	-5	10
Continuous	DV_Hoehe_Mittelsteg	0	8	-5	12
Continuous	DV_Hoehe_Nase	0	5	0	10

Add...

OK

Connecting META to LS-OPT

Stage for META

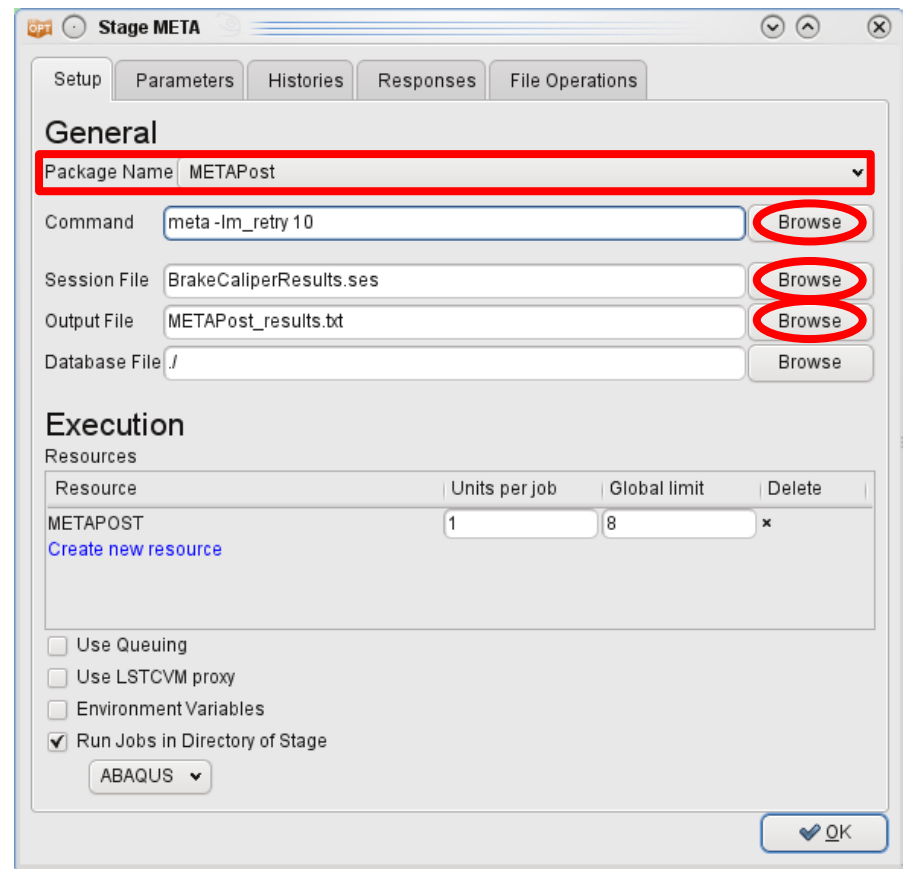
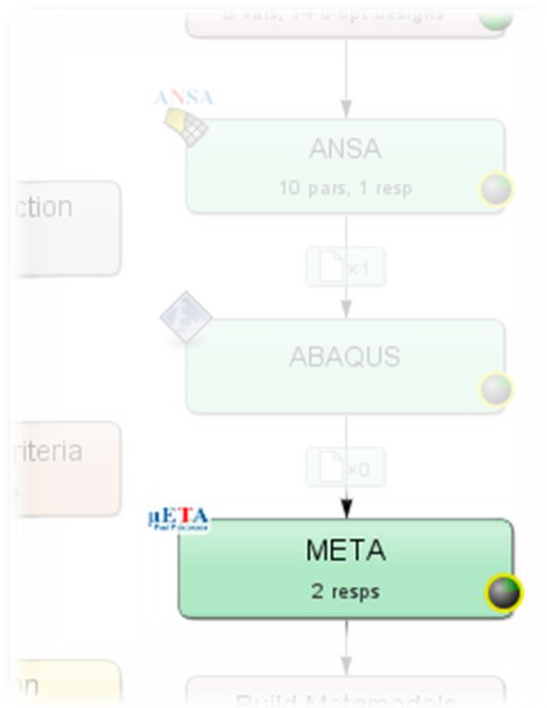

Connecting META to LS-OPT

META → Output file → Responses and Histories in LS-OPT

```
#OptimizerSetup Response & history File created by META post  
RESPONSES  
1,nodes_rel_disp,0.174171448  
2,max_stress,169.780731  
END
```

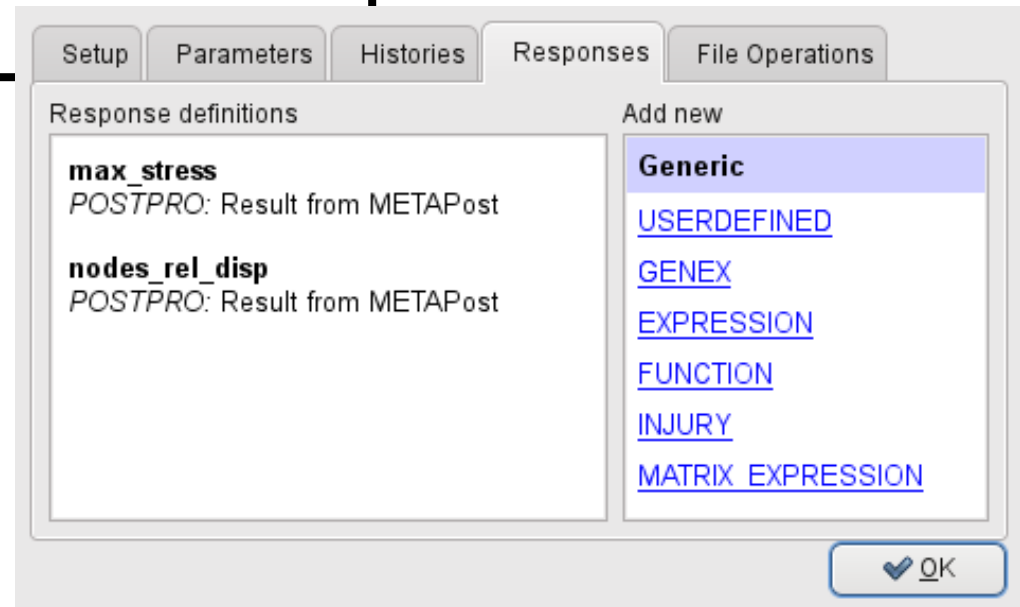

Optimization Run

LS-OPT → ANSA → Solver → META → LS-OPT

LS-OPT determines set of DV and outputs DV file

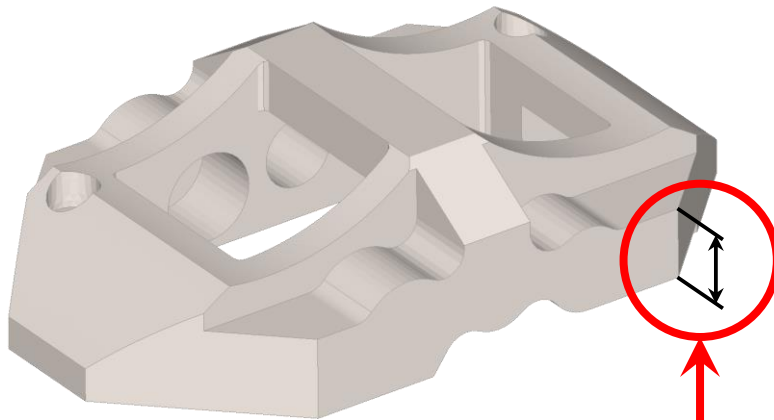

#	ID	DESIGN VARIABLE NAME	TYPE	RANGE	CURRENT VALUE	MIN VALUE
3,	DV_Hoeh	DV_Hoeh	REAL,	BOUNDS,	0.,	-5., 12.
2,	DV_Breite	DV_Breite	REAL,	BOUNDS,	0.,	-5., 10.
1,	DV_Breite	DV_Breite	REAL,	BOUNDS,	0.,	0., 20.
6,	DV_Breite	DV_Breite	REAL,	BOUNDS,	0.,	0., 25.
9,	DV_Hoeh	DV_Hoeh	REAL,	BOUNDS,	0.,	0., 10.
4,	DV_Breite	DV_Breite	REAL,	BOUNDS,	0.,	-20., 13.
7,	DV_Breite	DV_Breite	REAL,	BOUNDS,	0.,	-20., 13.
5,	DV_Breite	DV_Breite	REAL,	BOUNDS,	0.,	-13., 10.
8,	DV_Breite	DV_Breite	REAL,	BOUNDS,	0.,	-13., 10.
10,	DV_Breite	DV_Breite	REAL,	BOUNDS,	0.,	0., 20.

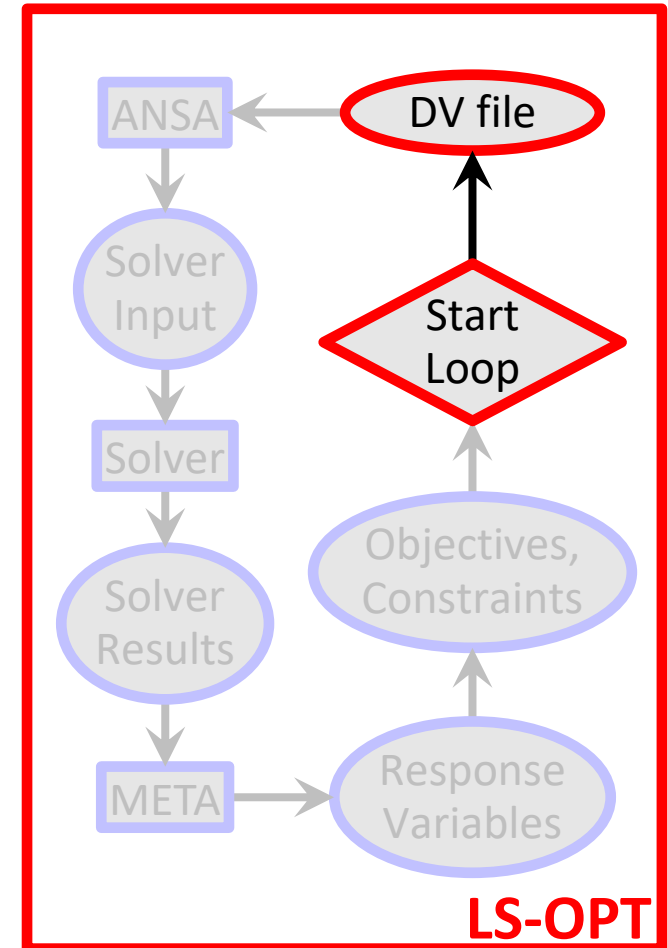

Optimization Run

LS-OPT → **ANSA** → Solver → META → LS-OPT

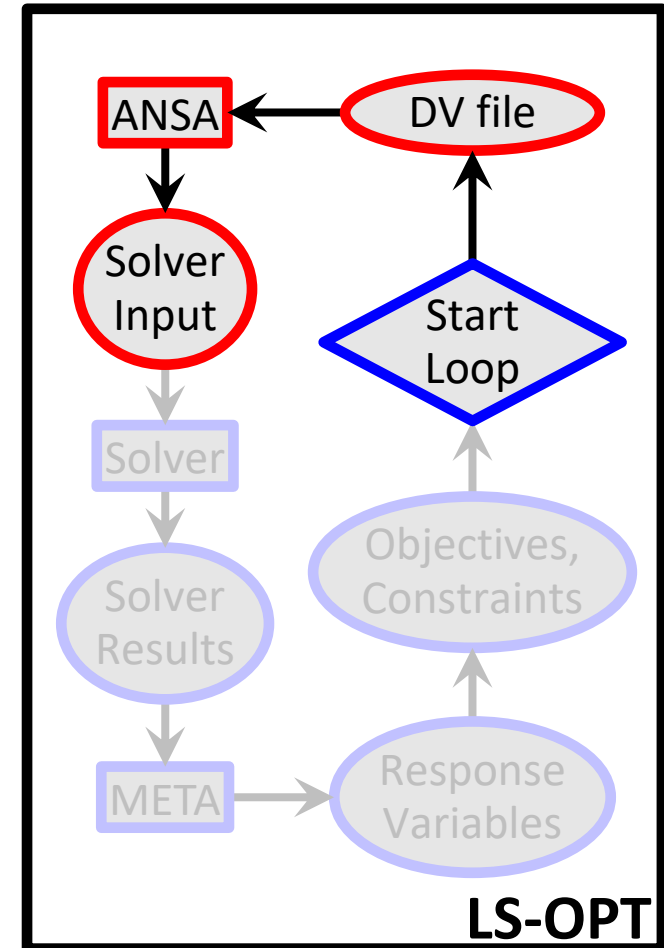
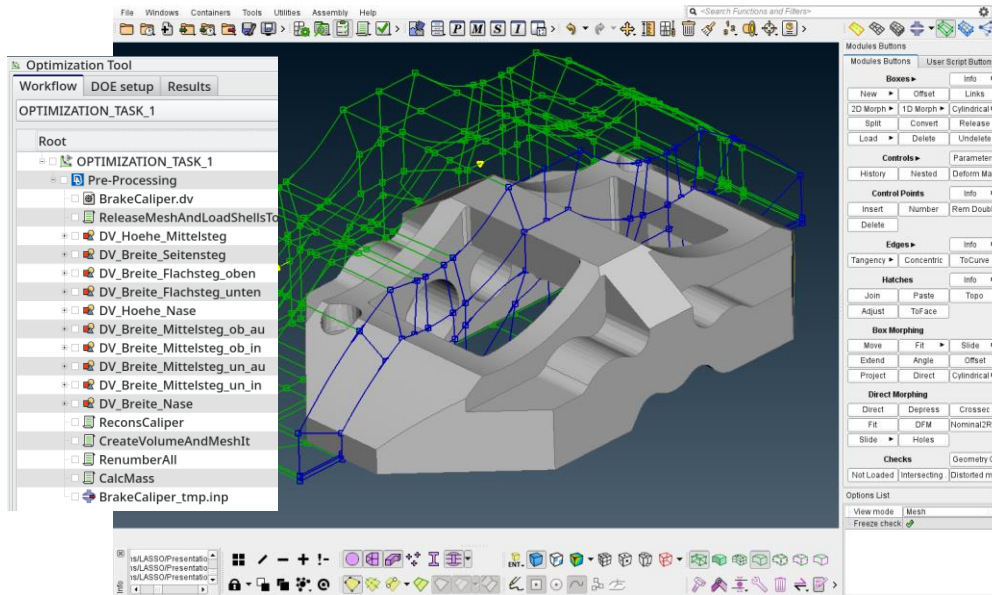

Optimization Run

LS-OPT → **ANSA** → Solver → META → LS-OPT

- ANSA reads DV from DV file

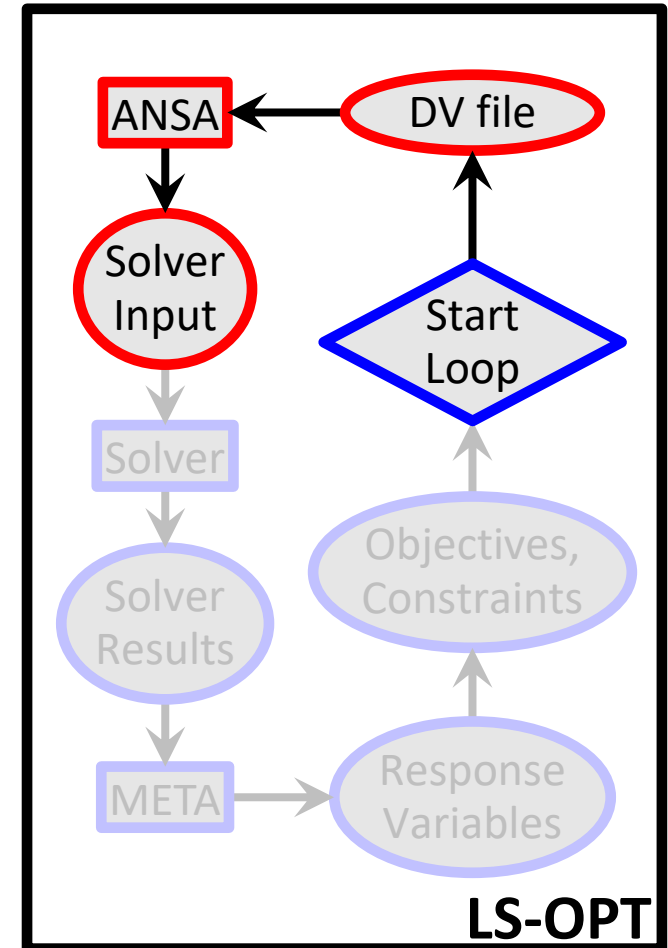
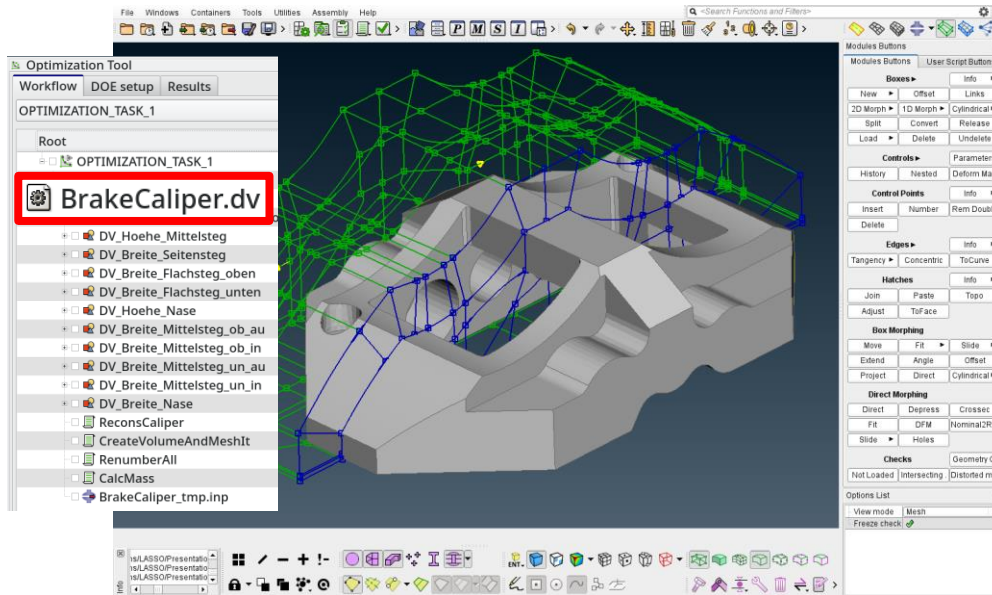

Optimization Run

LS-OPT → **ANSA** → Solver → META → LS-OPT

- ANSA reads DV from DV file
- executes Optimization Task sequence

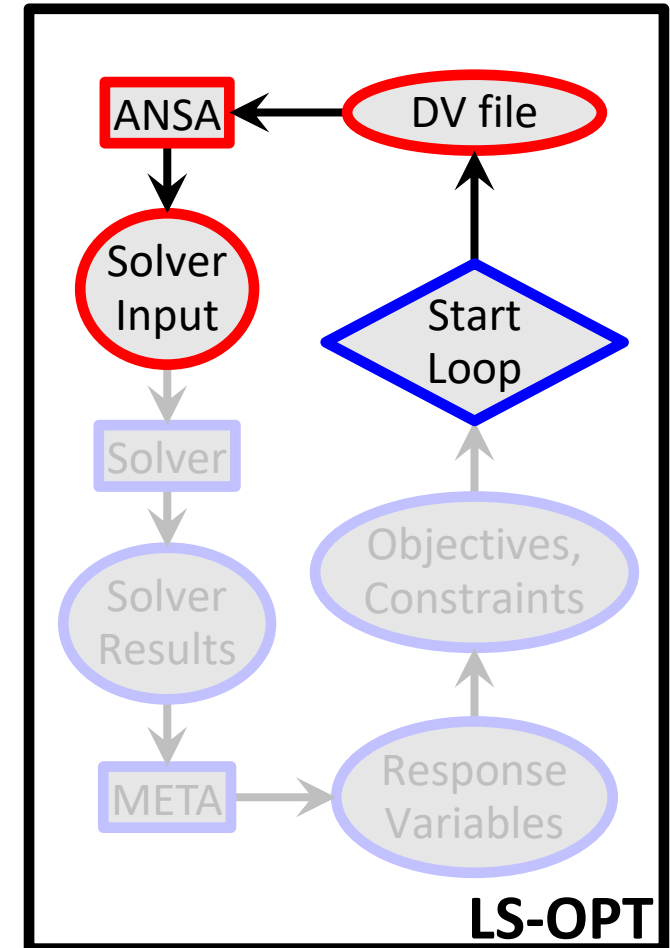
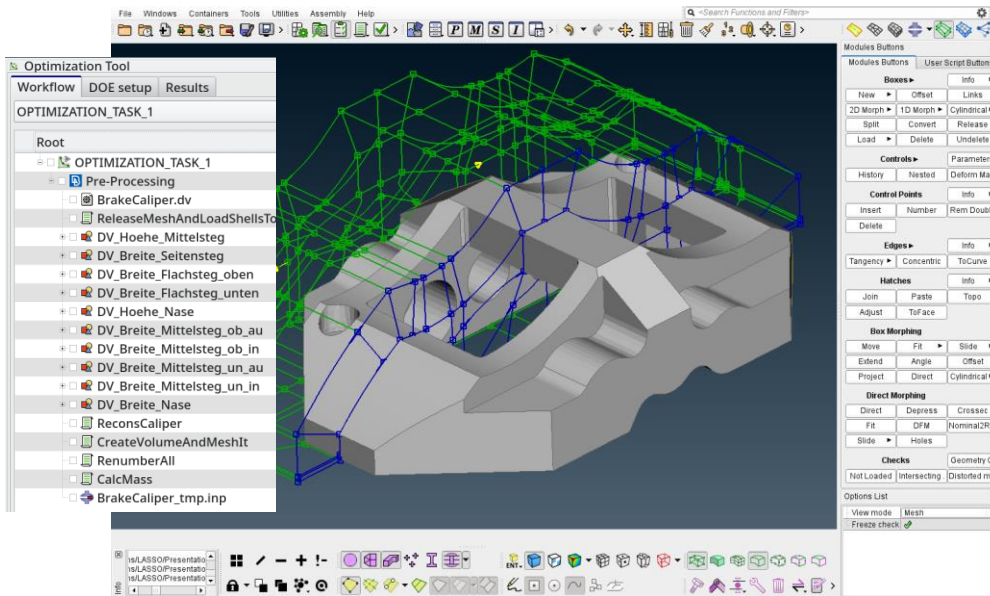

Optimization Run

LS-OPT → **ANSA** → Solver → META → LS-OPT

- ANSA reads DV from DV file
- executes Optimization Task sequence

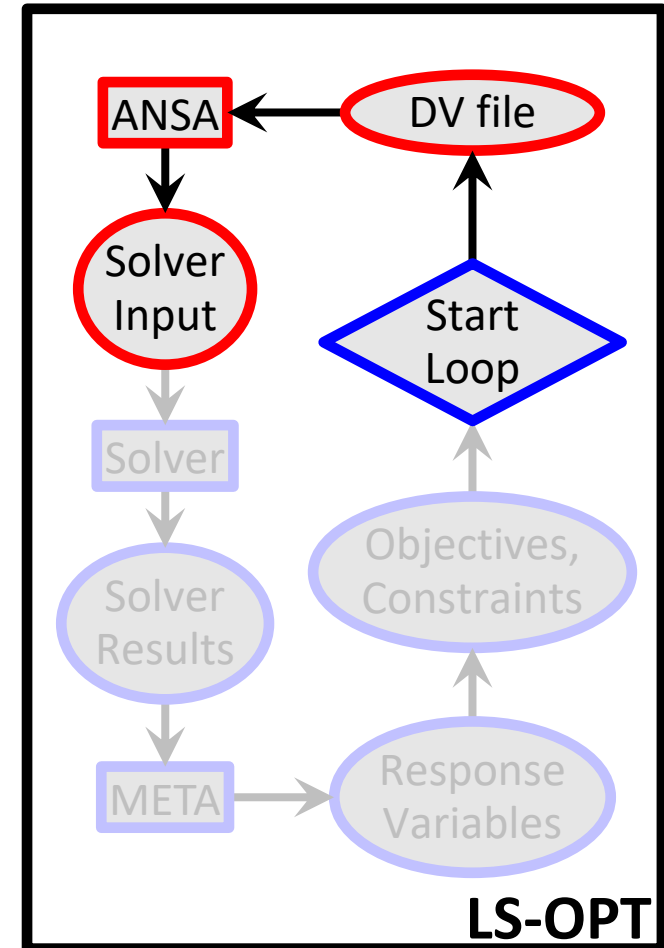
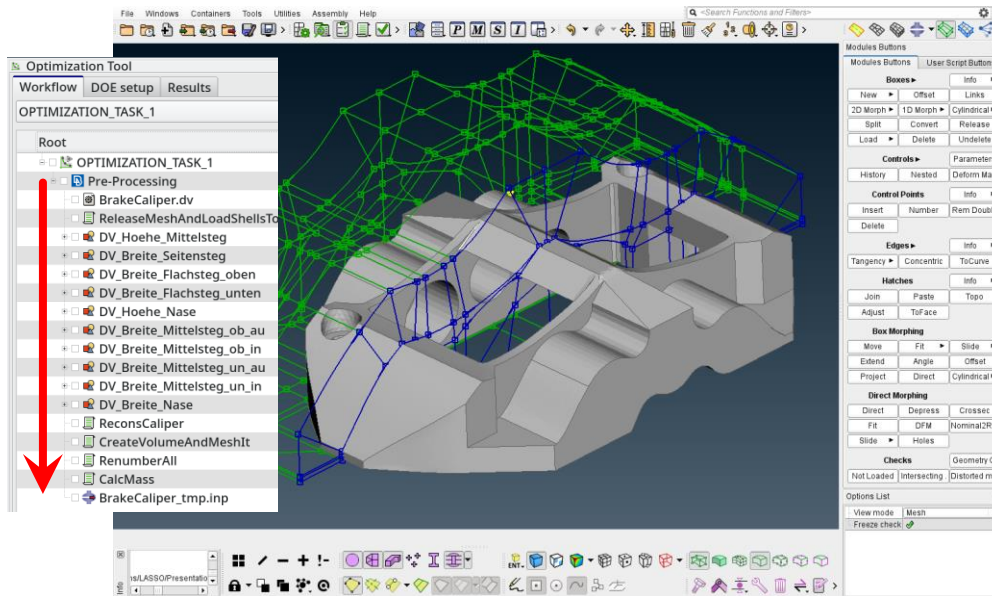

Optimization Run

LS-OPT → **ANSA** → Solver → META → LS-OPT

- ANSA reads DV from DV file
- executes Optimization Task sequence
- outputs solver input deck

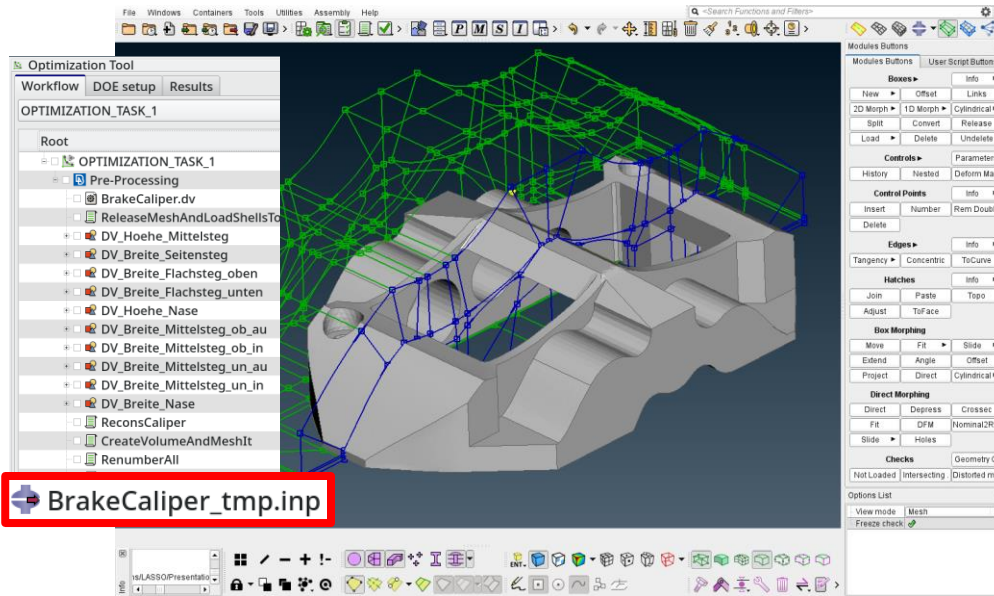

***.key / *.nas / *.inp**

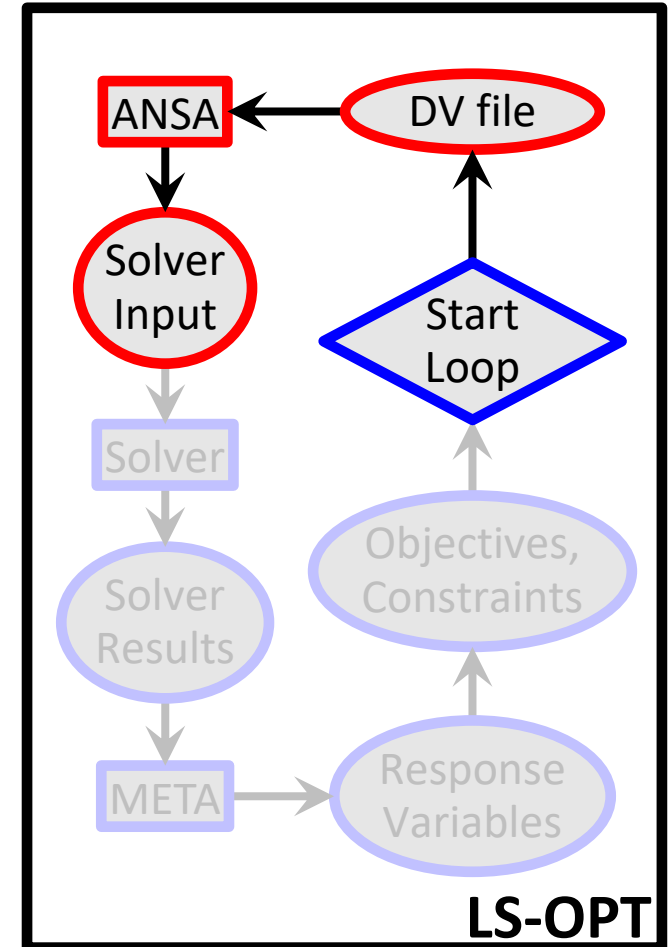

Optimization Run

LS-OPT → ANSA → **Solver** → META → LS-OPT

- LS-OPT invokes solver runs

*.key / *.nas / *.inp

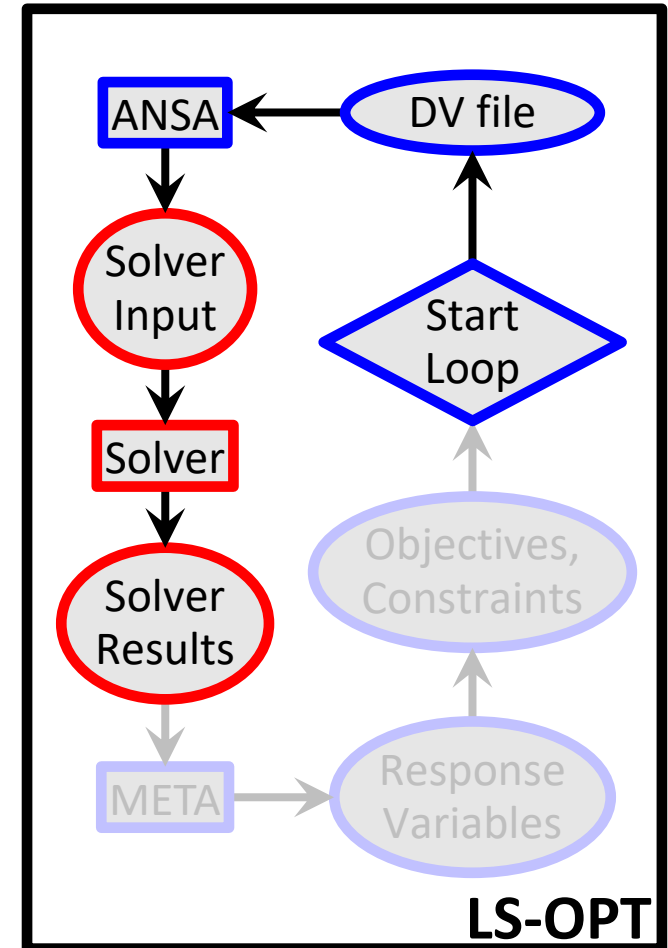
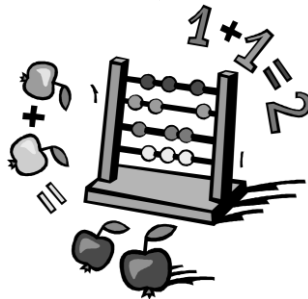

Optimization Run

LS-OPT → ANSA → **Solver** → META → LS-OPT

- LS-OPT invokes solver runs
- Solver produces result files

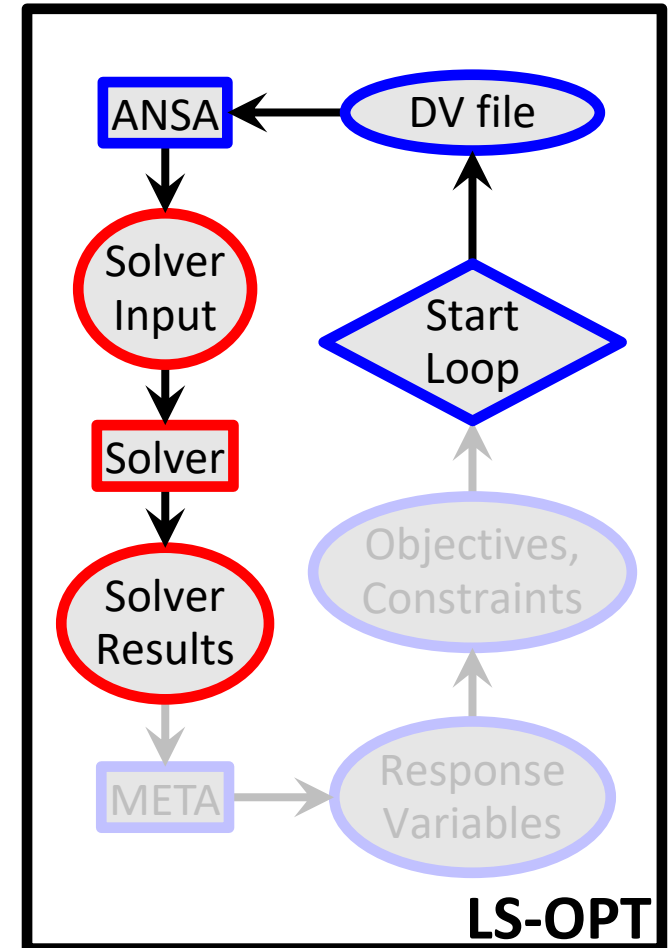
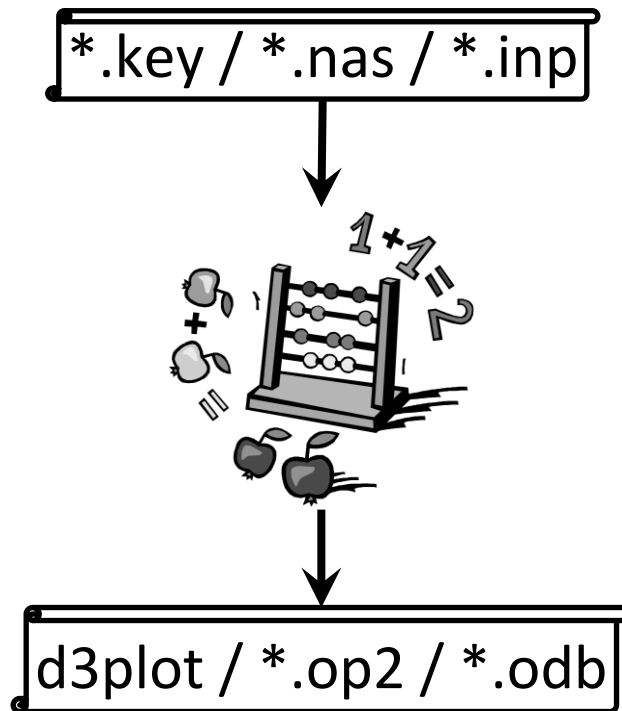

Optimization Run

LS-OPT → ANSA → Solver → **META** → LS-OPT

META executes session file to extract responses from solver results

d3plot / *.op2 / *.odb

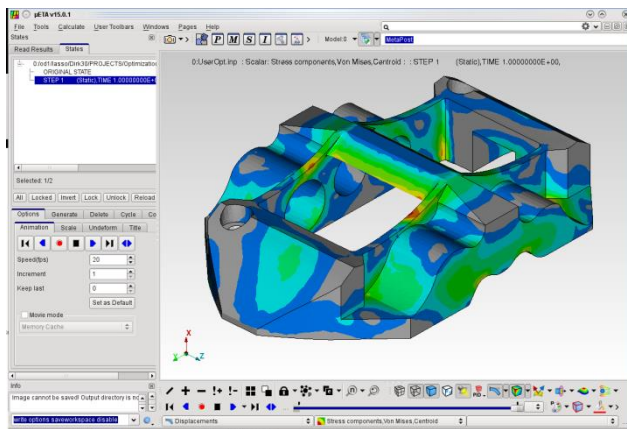

```
#OptimizerSetup Response & history File
RESPONSES
  1,nodes_rel_disp,0.174171448
  2,max_stress,169.780731
END
```

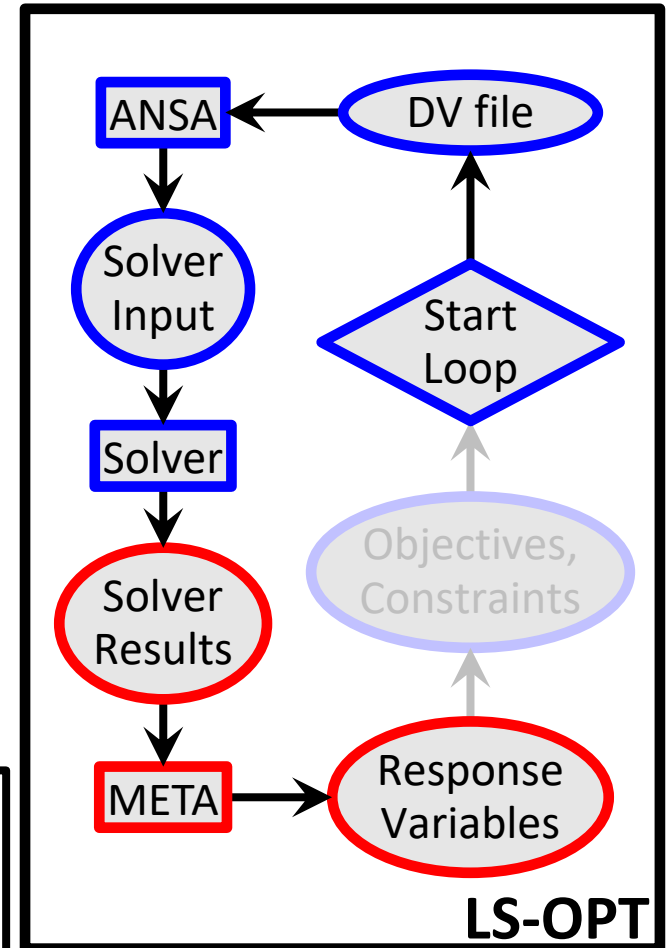

Optimization Run

LS-OPT → ANSA → Solver → META → **LS-OPT**

LS-OPT reads responses and evaluates objectives/constraints

```
#OptimizerSetup Response & history File
RESPONSES
1,nodes_rel_disp,0.174171448
2,max_stress,169.780731
END
```

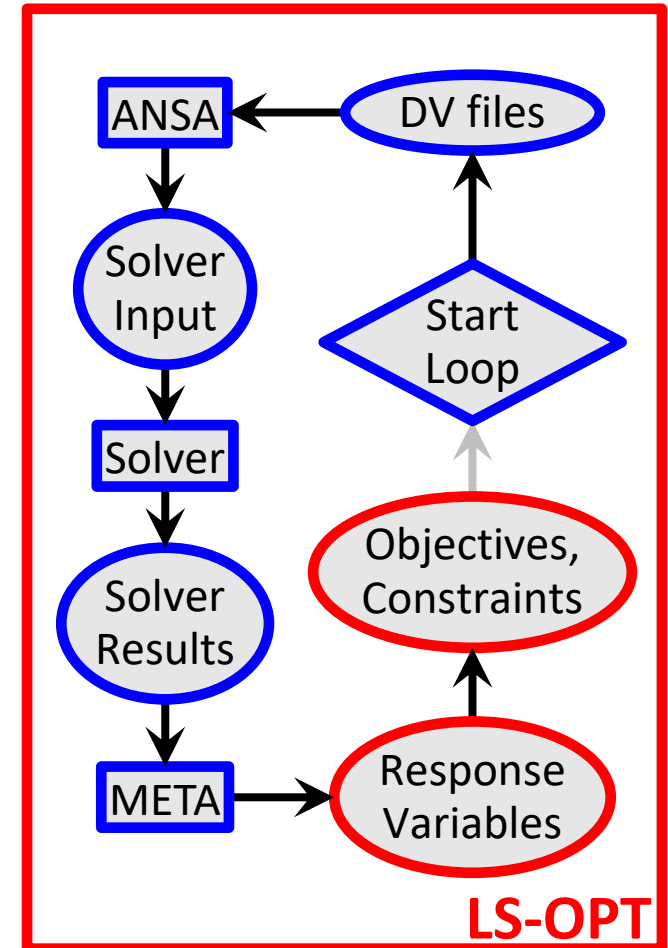
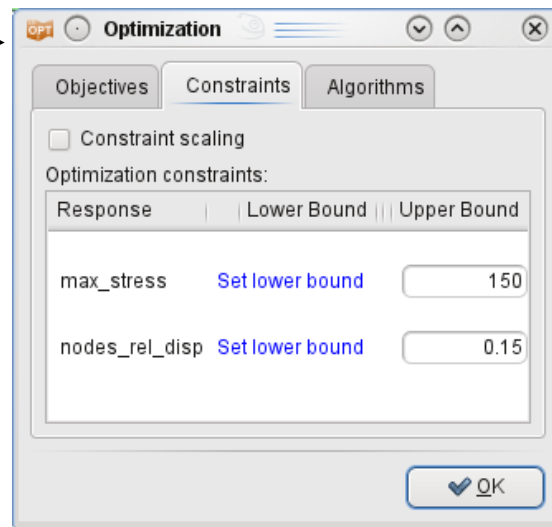

Optimization Run

LS-OPT → ANSA → Solver → META → **LS-OPT**

- LS-OPT calculates new values for DVs

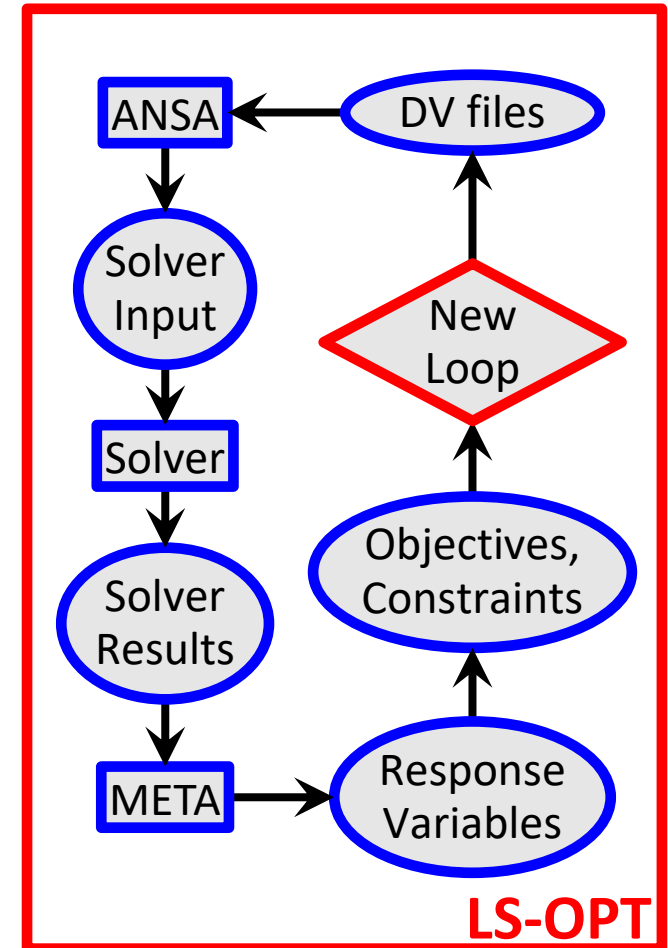

Optimization Run

LS-OPT → ANSA → Solver → META → **LS-OPT**

- LS-OPT calculates new values for DVs
- Whole process repeated until optimal solution

Initial

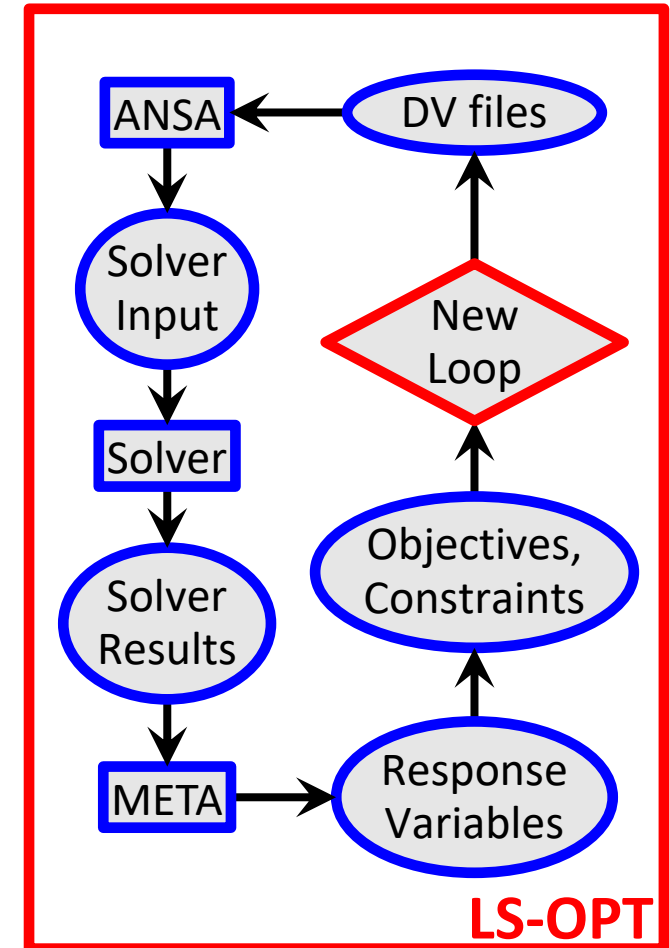
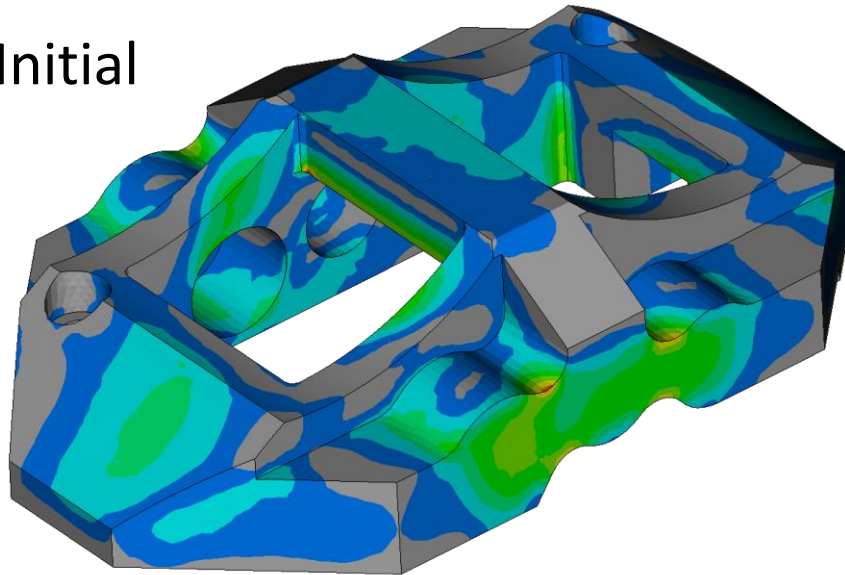

Optimization Run

LS-OPT → ANSA → Solver → META → **LS-OPT**

- LS-OPT calculates new values for DVs
- Whole process repeated until optimal solution

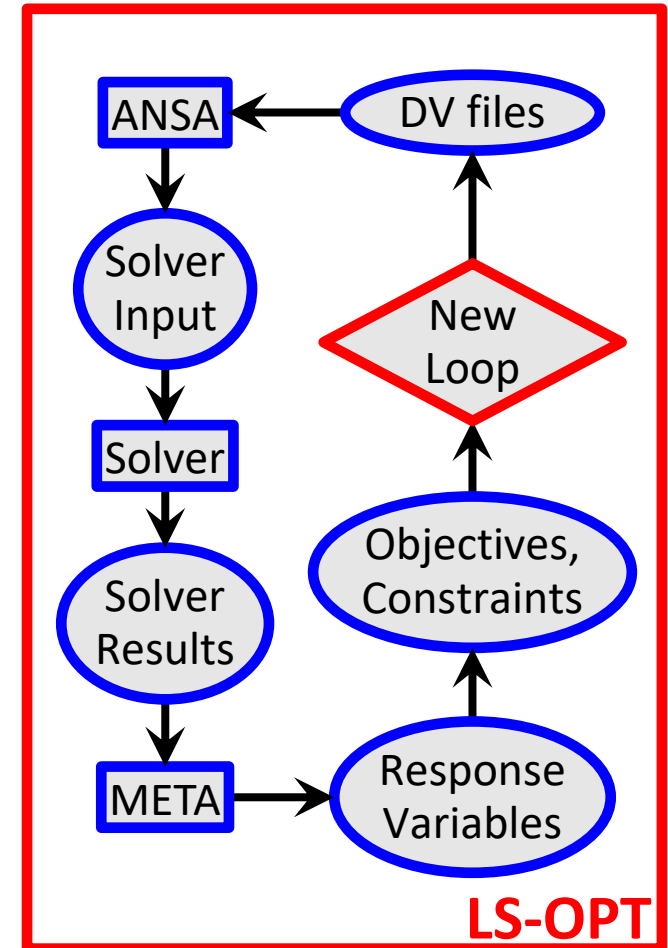
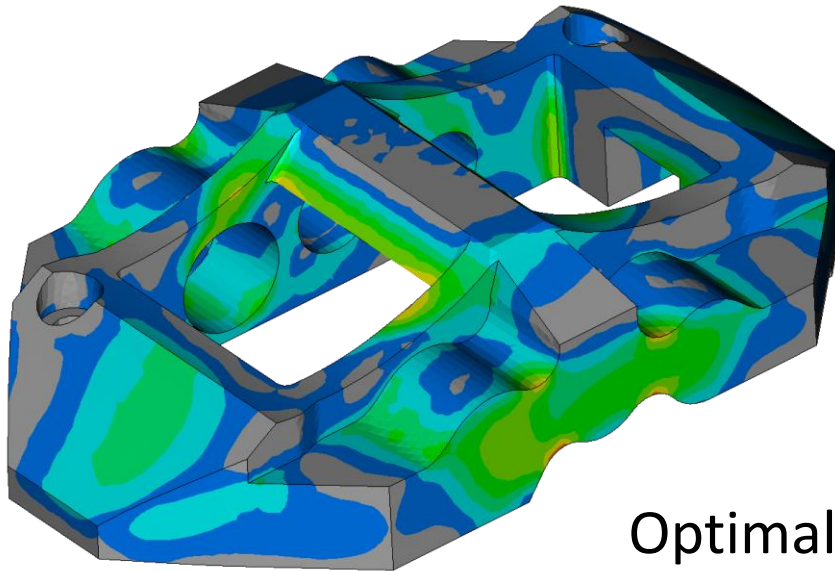

Ευχαριστώ πολύ

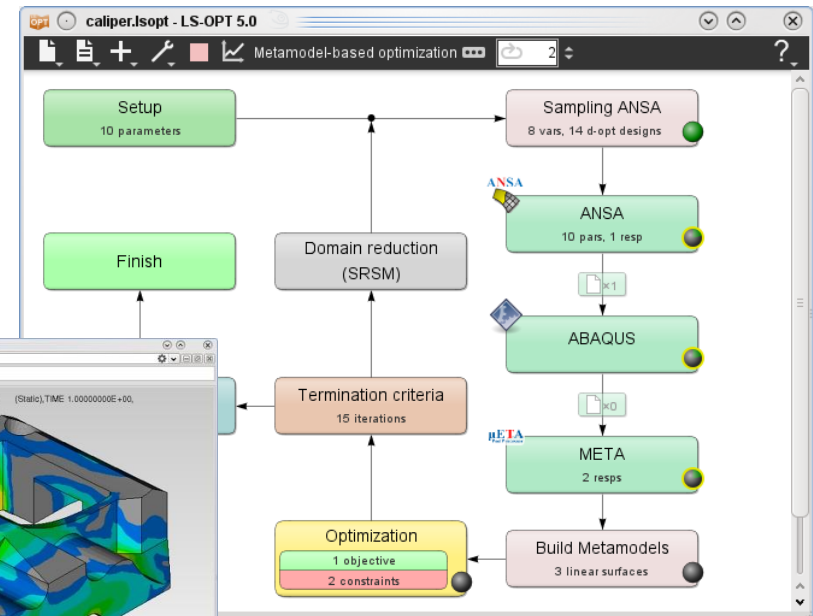
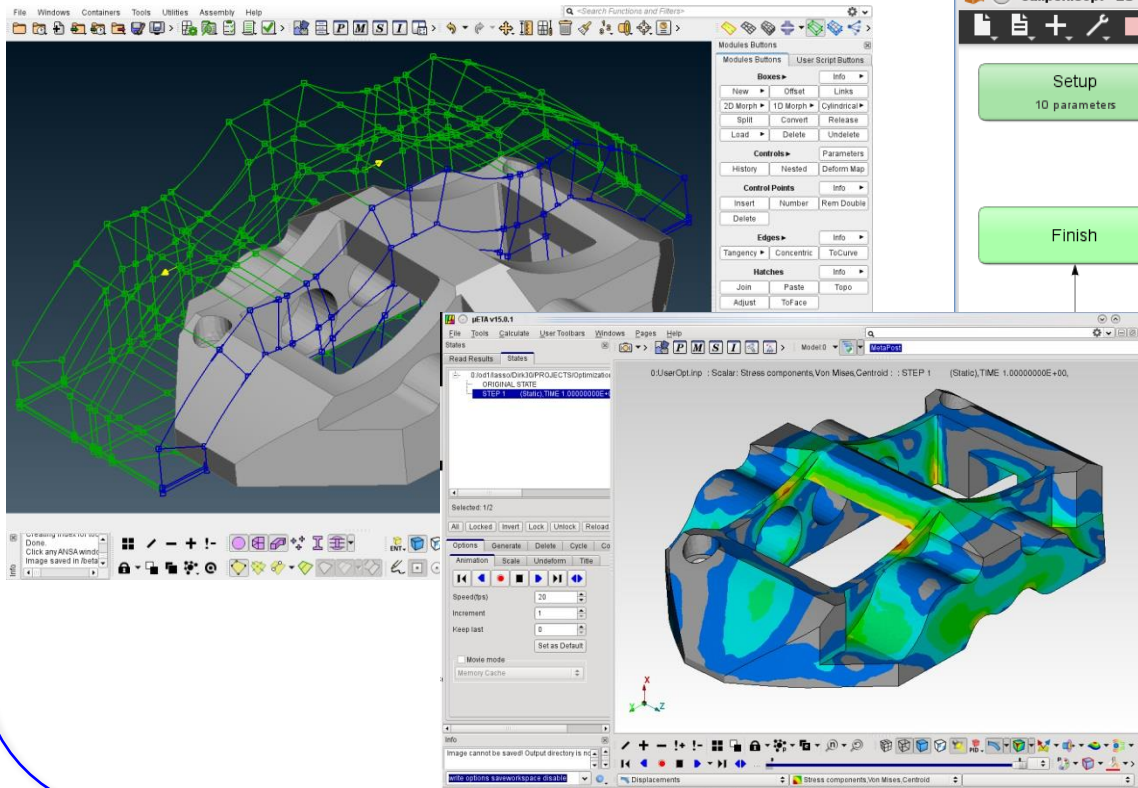

Ευχαριστώ πολύ

More information and examples on
www.lsoptsupport.com

Mail: ansa@lasso.de

