

Basics of Welding Simulation and Heat Treatment Simulation Applications and Benefits

Infotag Schweißen und
Wärmebehandlung
14.04.2016
Zürich

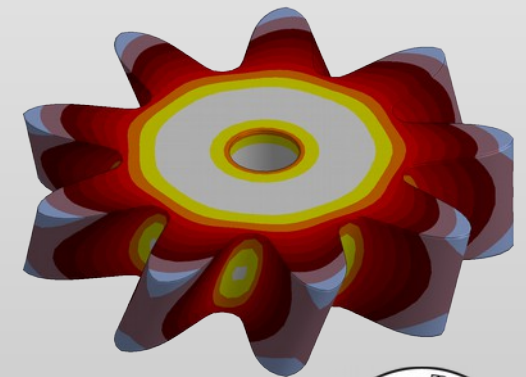

Dr.-Ing. Tobias Loose

Ingenieurbüro Tobias Loose, Herdweg 13, D- 75045 Wössingen
loose@tl-ing.de www.tl-ing.eu



Numerical Simulation for Welding and Heat Treatment since 2004

- Consulting
- Training
- Support
- Software Development
- Software Distribution

for **Welding Simulation** and **Heat Treatment Simulation**

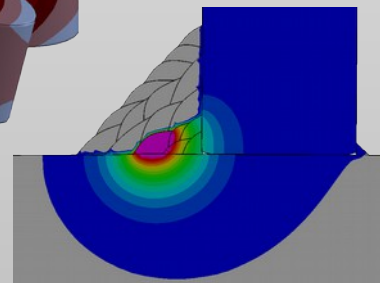
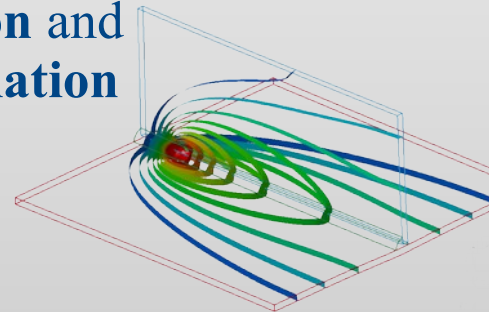
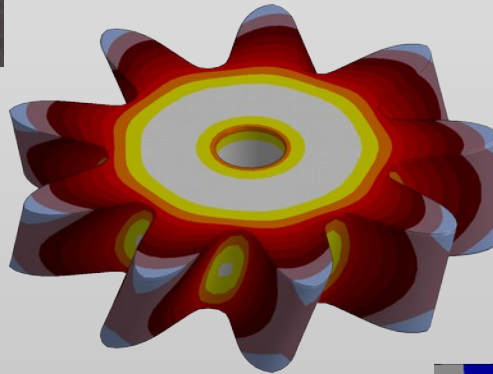

www.WeldWare.eu

WeldWare®
Schweißtechnologisches Beratungssystem

GSI SLV
Mecklenburg-Vorpommern

In **WeldWare®** steckt jahrzehntelange Erforschung vereint in einer Software: Wärmeführung beim Schweißen von Stahl - Gefügewandlungen und Eigenschaften in der Wärmeinflußzone

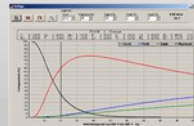

www.SimWeld.eu



SimWeld



In **SimWeld** steckt langjährige Forschung und Entwicklung in der anwendungsnahen Schweißprozesssimulation vom

Institut für Schweißtechnik und Fügechnik der RWTH Aachen.



www.DynaWeld.eu

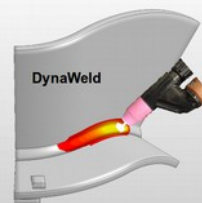
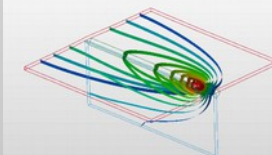

DynaWeld

Welding and Heat-Treatment with LS-DYNA
Distortion – Residual Stress – Microstructure

Internet:
DEutsch: www.loose.at
ENglish: www.tl-ing.eu
ESpañol: www.loose.es

Motivation and Examples

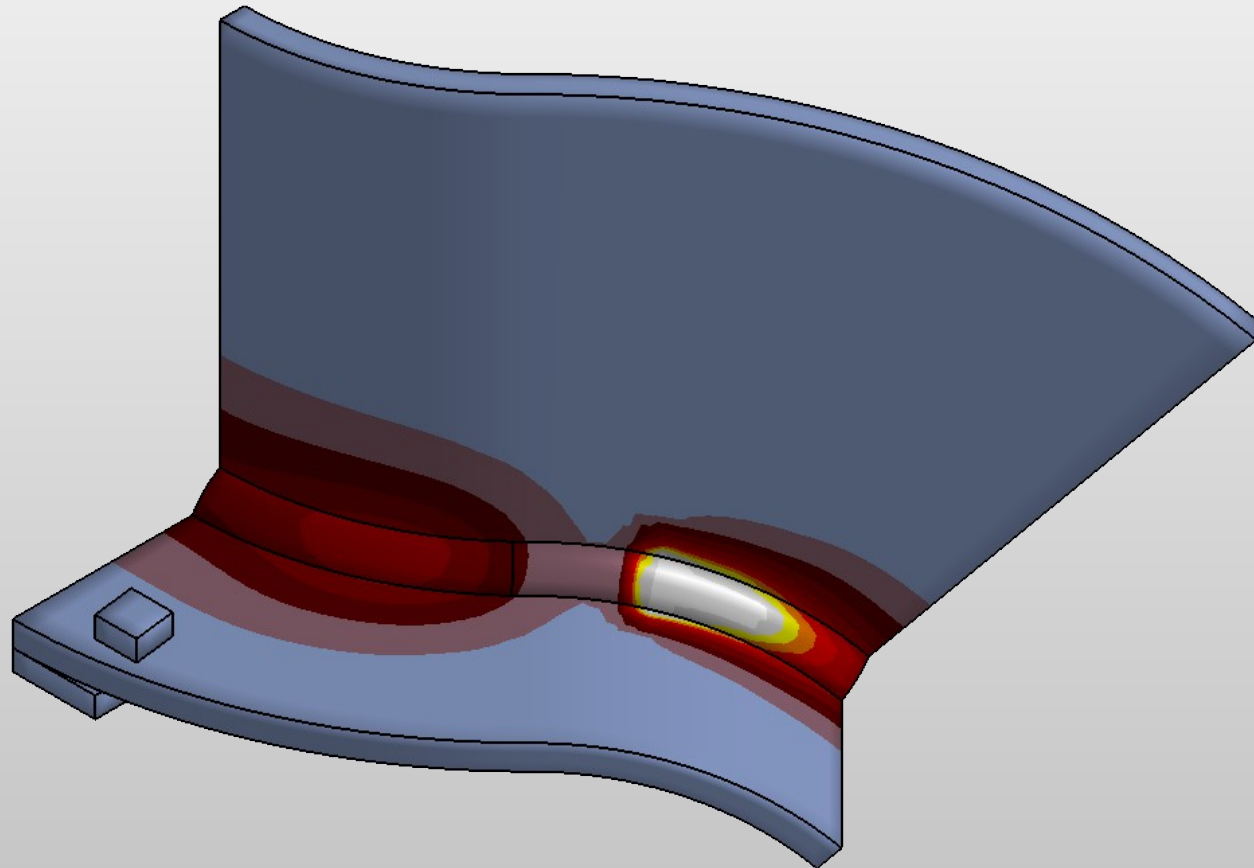

Welding of a T-Joint

- Double sided T-Joint $a = 4$ mm
- Plate S355 thickness 8 mm
- 3 Tacks double sided
- Travel speed 80 cm/min
- Current: 390 A
- Voltage: 30 V

- Start Time Tack 1: 0 s
- Start Time Tack 2: 20 s
- Start Time Weld 1: 1000 s
- Start Time Weld 2: 1023 s
- Weld 1 and Weld 2 have the same travel direction



Foto: Volvo

Input-Parameter SimWeld

Workpiece parameters (Ctrl + 1)

Geometry
 EN ISO **EN ISO 9692-1: 2003 (D)**

Joint type: **Square edges (3.1.1)**

width: 40,00 [mm] height: -1,00 [mm]
 t1: 8,00 [mm] t2: 8,00 [mm]
 b: 0,00 [mm] c: -1,00 [mm]
 radius: -1,00 [mm] e: -1,00 [mm]
 alpha: 90,00 [°] beta: -1,00 [°]

Left plate visible Right plate visible

Material
 Plates: S355

Position
 Type: Custom
 across: 45,00 [°] along: 0,00 [°]

Process parameters (Ctrl + 2)

Process parameters
 Welding speed: 80,00 [cm/min]
 Initial temperature: 20,00 [°C]

Simulation Options
 Consider gap

Calculation length: User defined
 100,00 [mm]

Mesh density: normal (1.0x)

Resources: medium
 Accuracy: medium

OK Cancel

Torch parameters (Ctrl + 3)

Wire
 Diameter: 1.6 [mm]
 Material: SG-Fe
 Wire initial heating
 Contact noz. t.: 20 [°C]

Position
 X: 0,00 [mm]
 Y: 0,00 [mm]
 L: 20,00 [mm]
 R: 20,00 [mm]

Angle
 Along: 0 [°]
 Across: 0 [°]

Equipment

Power source
 Select...: Custom
 Process type: Normal
 Wire feed: 7,0 [m/min]
 Voltage: 30,0 [V]
 Choke: 30,0 [%]

SimWeld Results

- $a = 4,4 \text{ mm}$
- $I = 390 \text{ A}$
- $V = 29,2 \text{ V}$

```

3D double ellipsoid source
10142,58600 //Q (W)
6005,89110 //Qf (W)
4136,69530 //Qr (W)
375,36136 //q0_front (W/mm3)
7,87233 //q0_rear (W/mm3)
2,58247 //af (mm)
31,54304 //ar (mm)
4,67305 //b (mm)
6,65324 //c (mm)
3,30435 //x0 (mm)
3,30435 //z0 (mm)
45,00001 //ay (degree)
80,00000 //vy (cm/min)
    
```

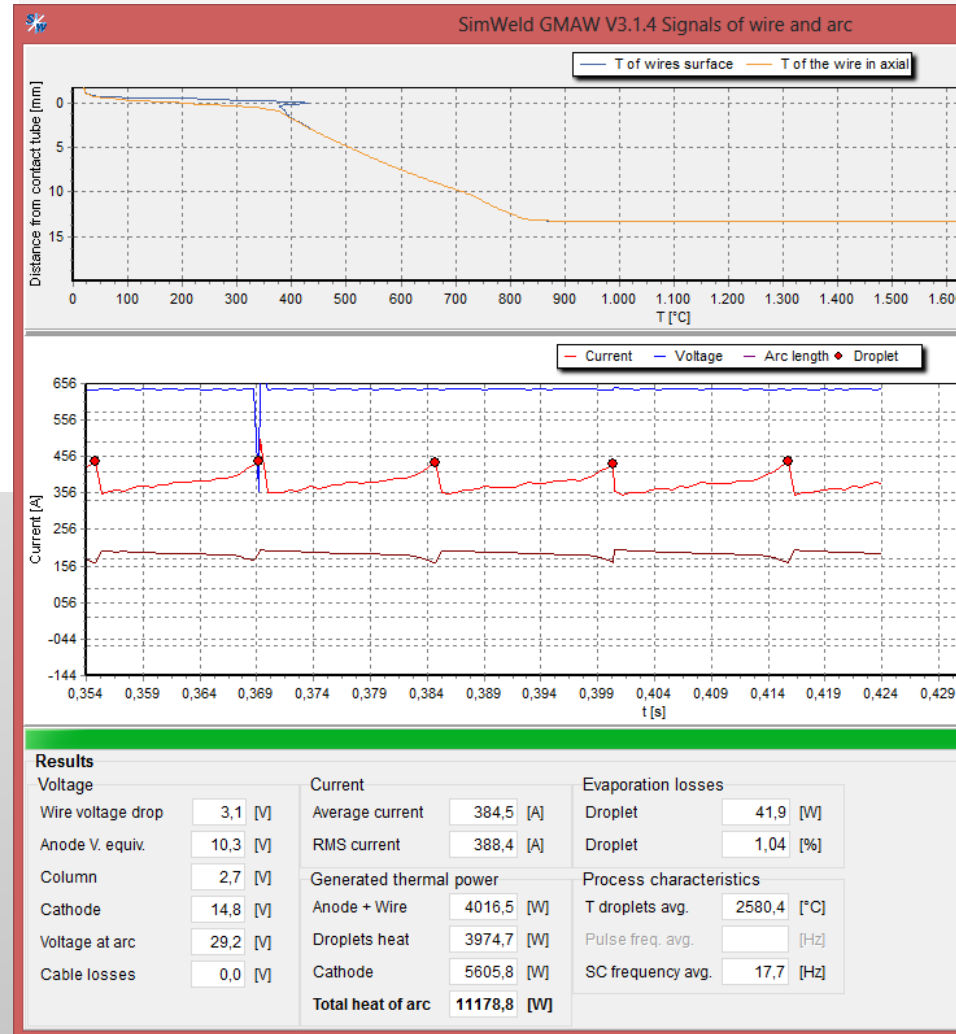
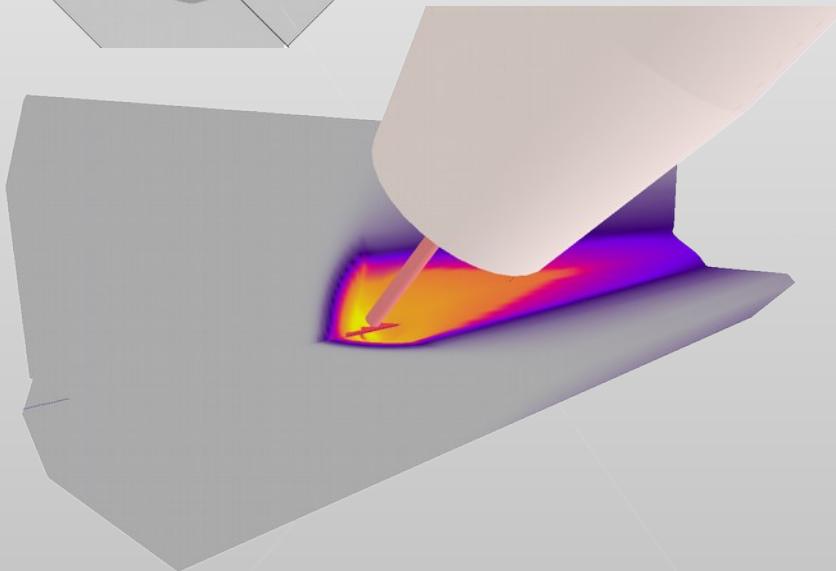
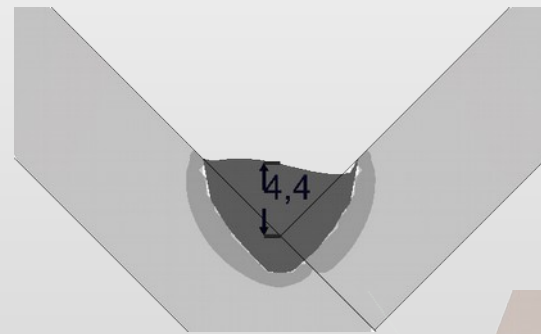

Temperature

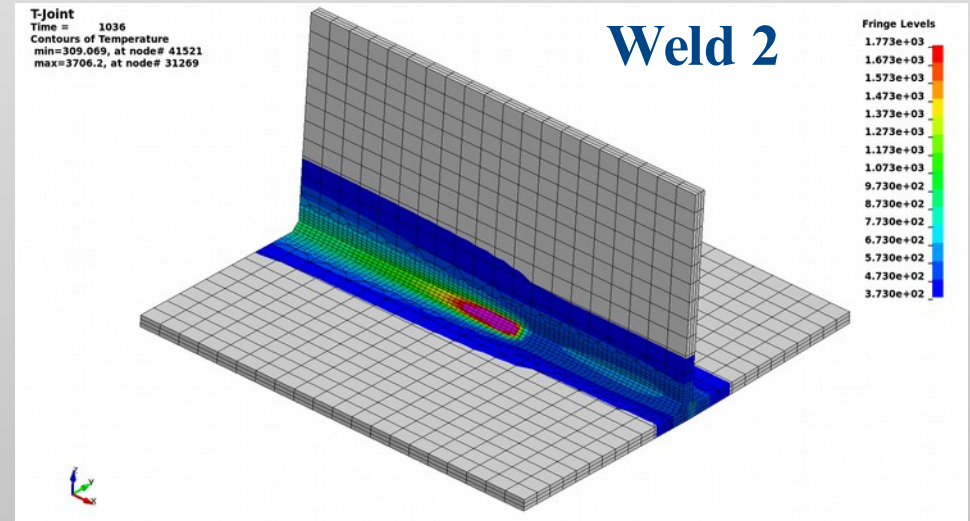
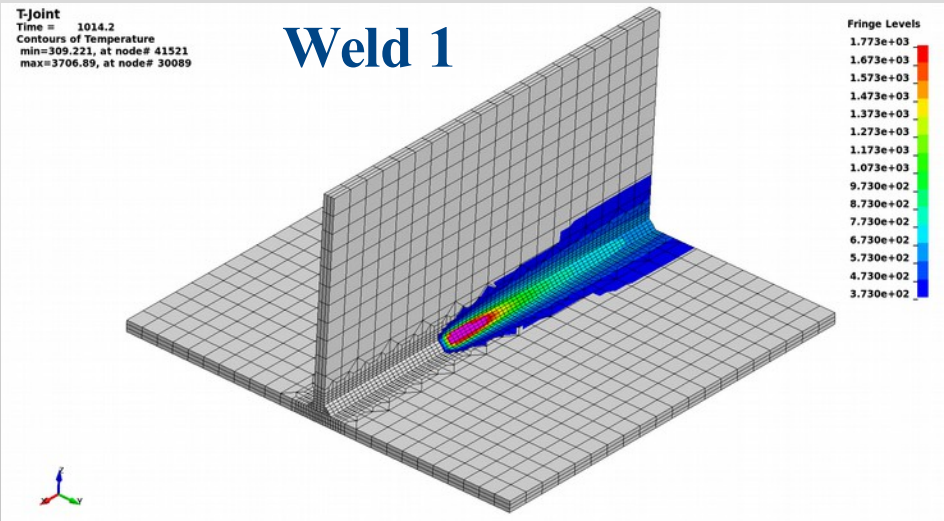
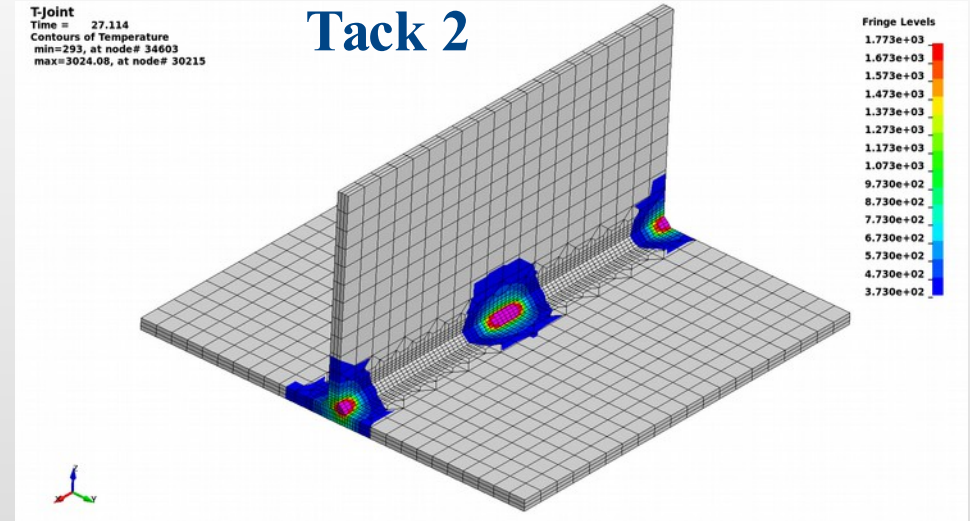
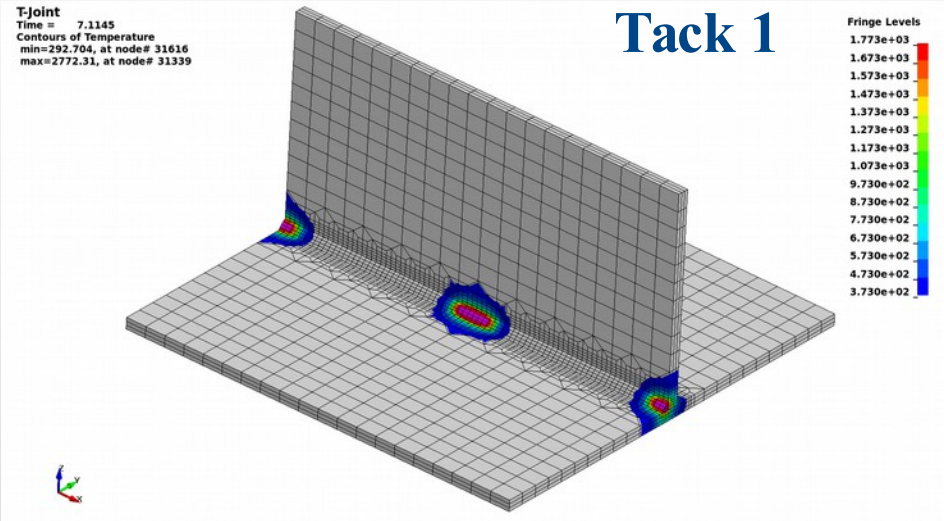

z-Distortion at Evaluation Path transformed to flat left side

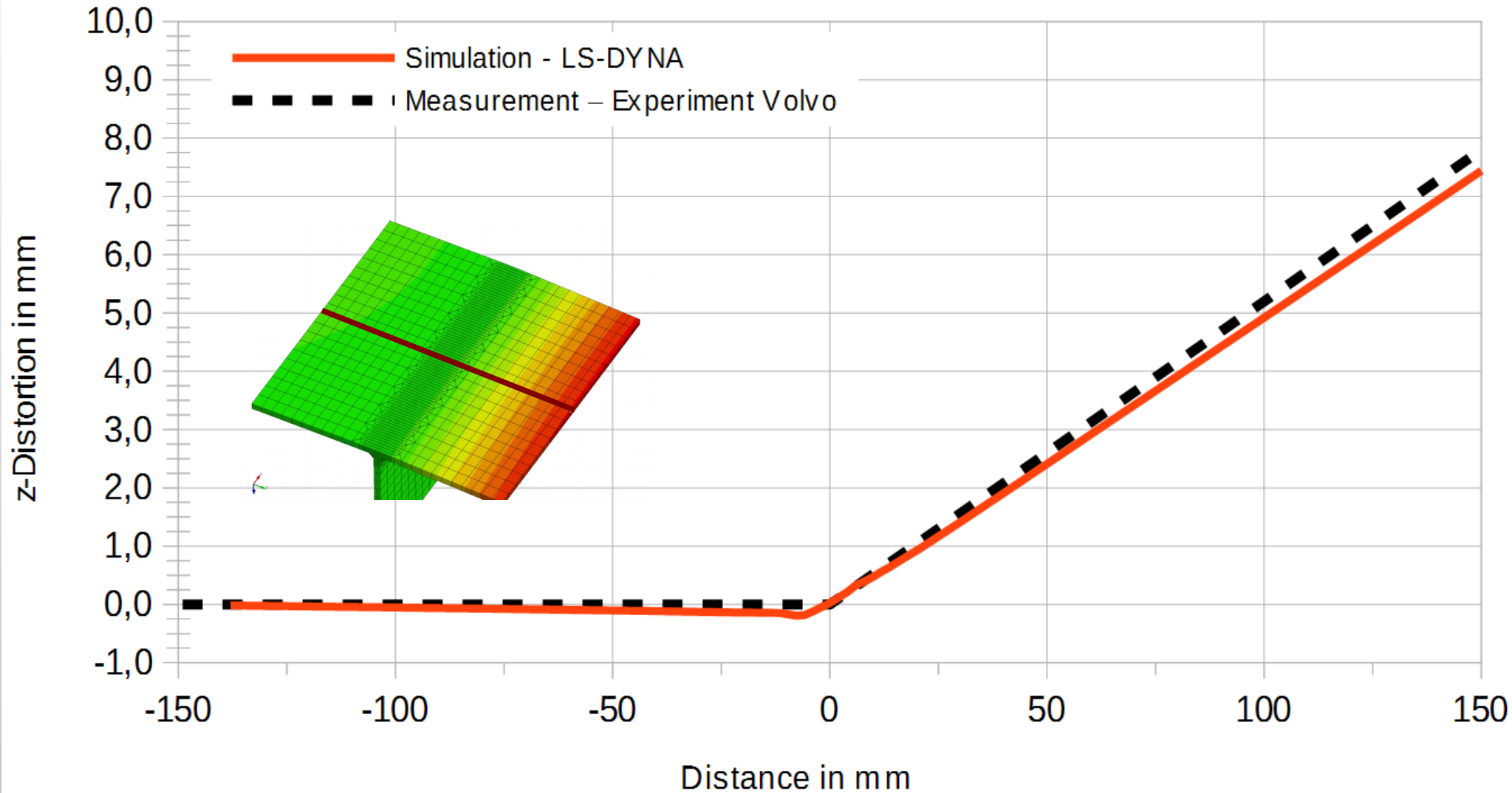

Curved Hollow Section Beam

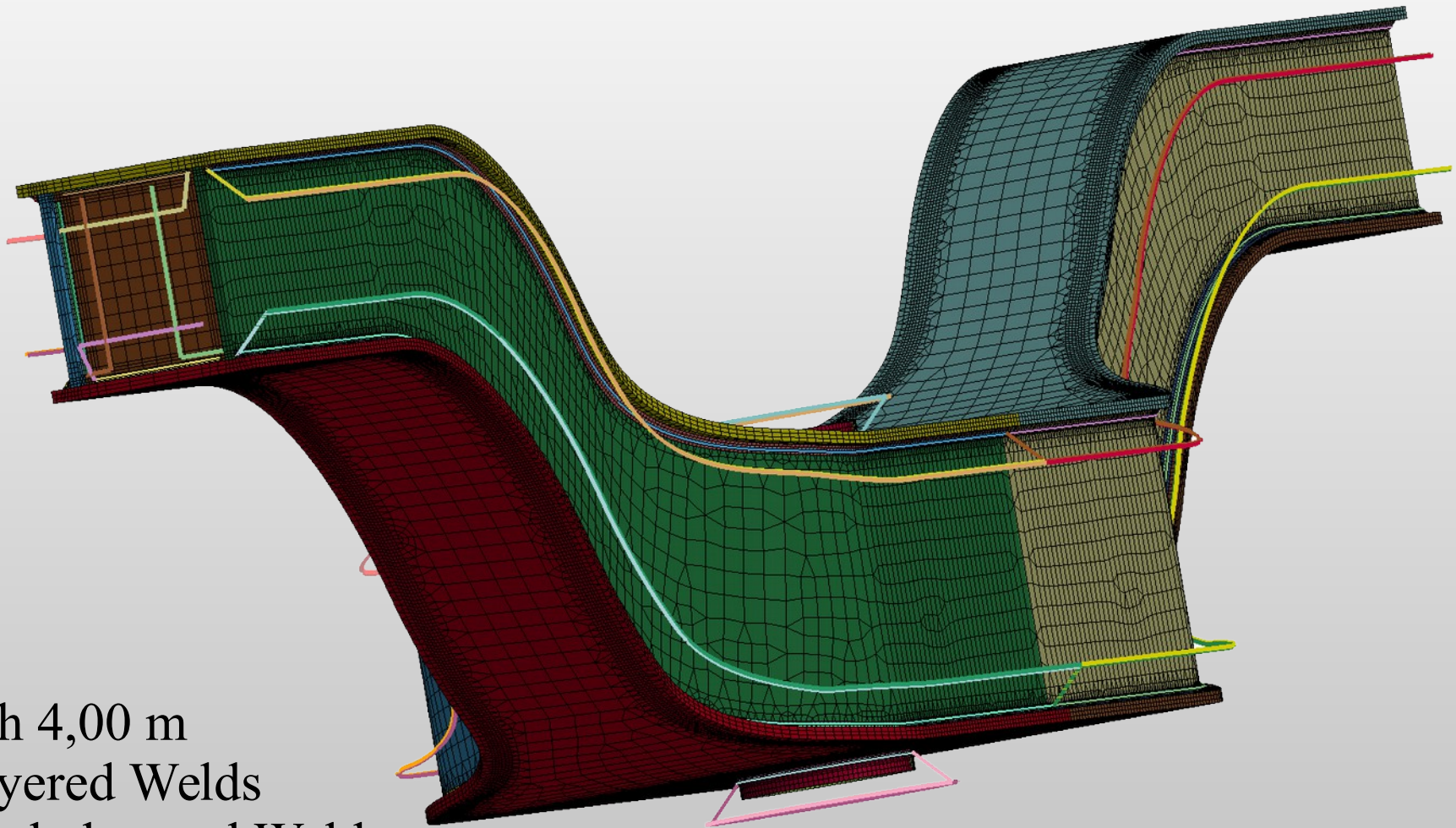

Length 4,00 m
8 2-layered Welds
12 single layered Welds

Curved Hollow Section Beam

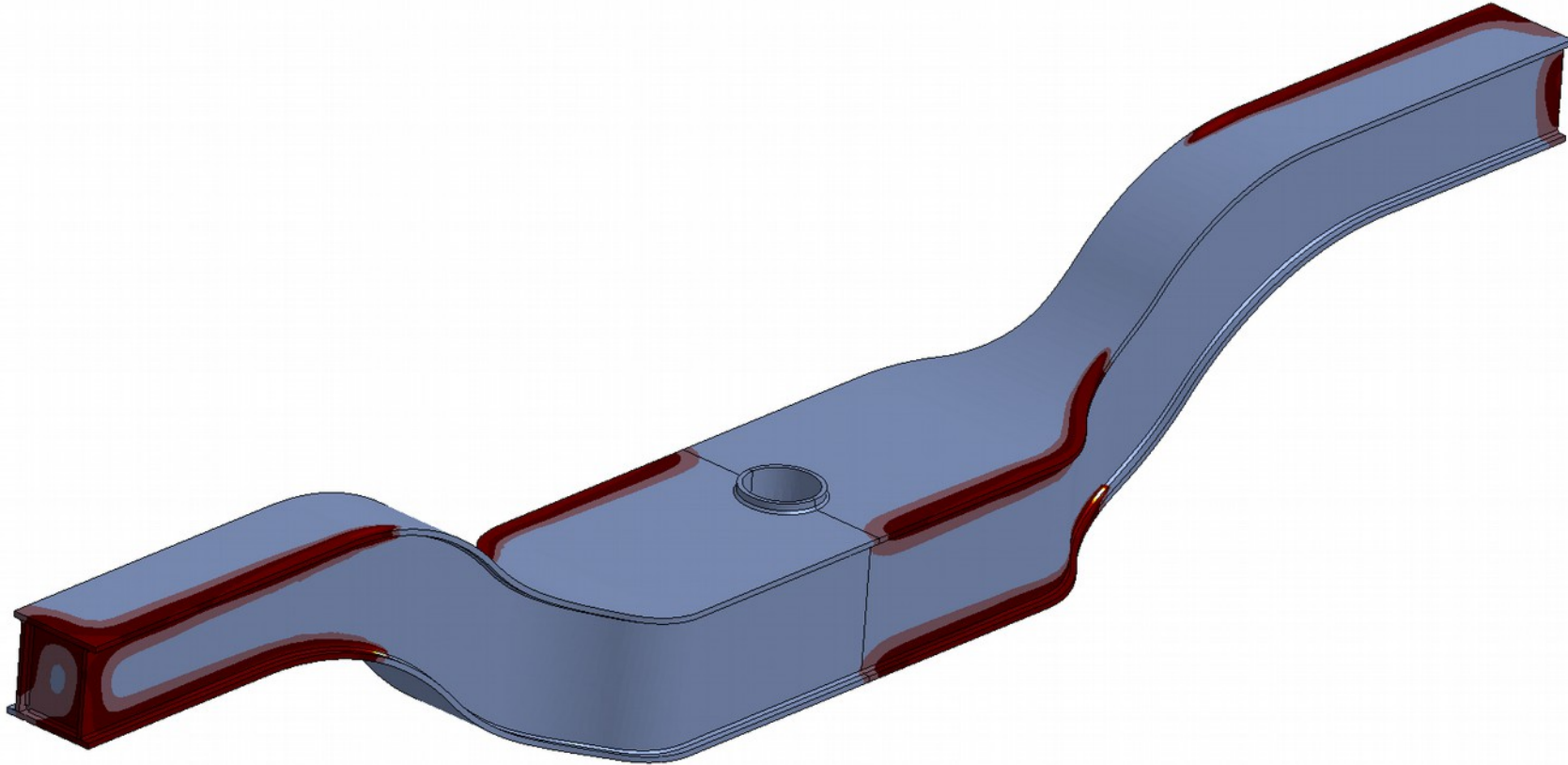

Autobody Sheet

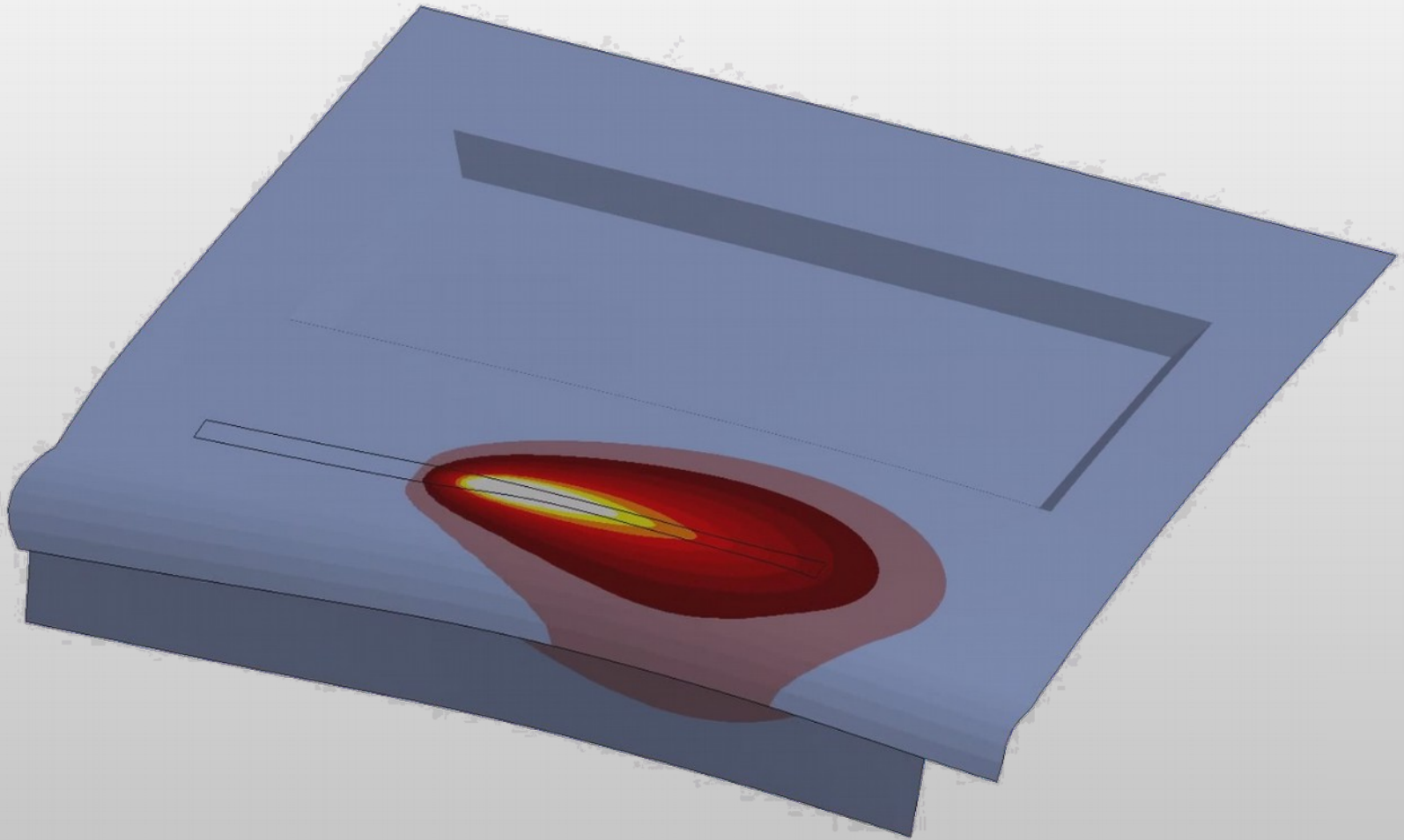

Autobody Sheet

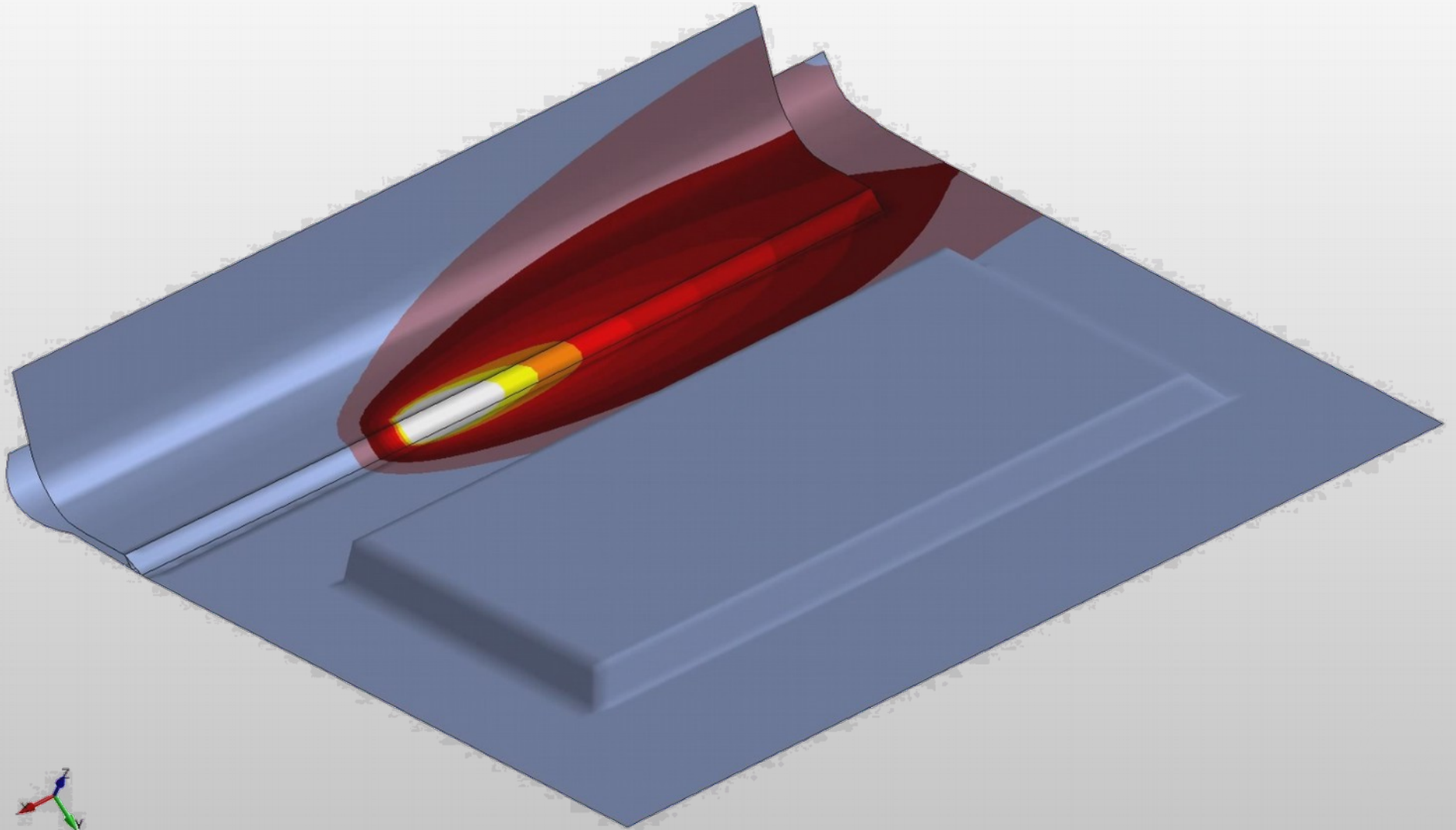

Welding

z-displacement 5-times scaled

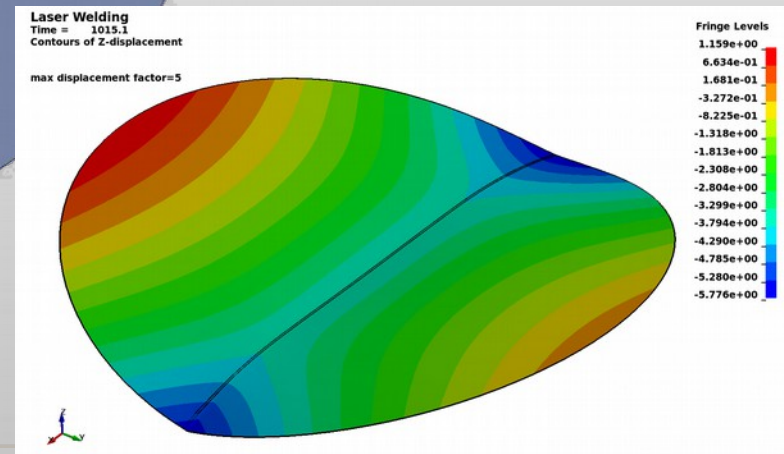
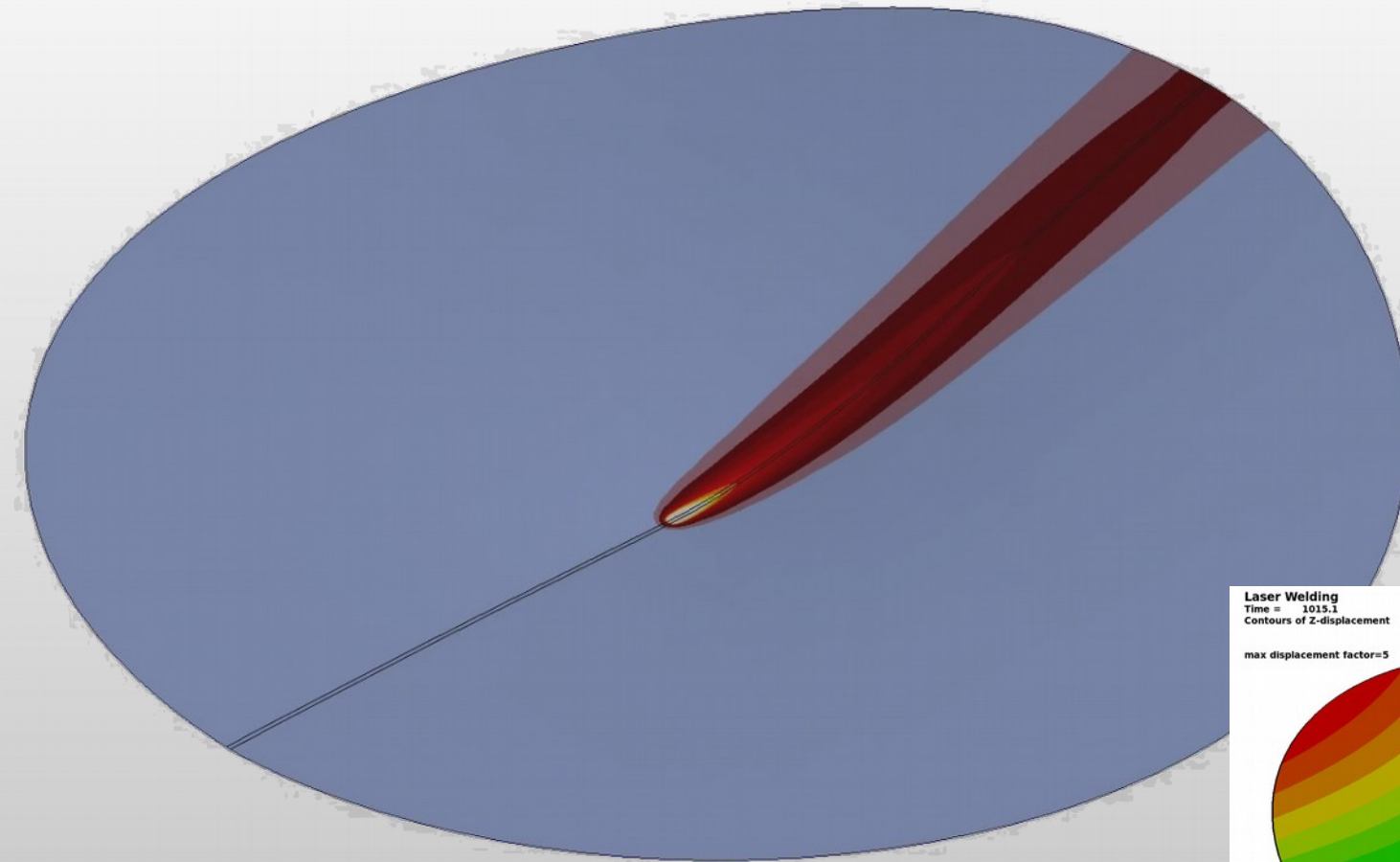

Weld of a Pipe with 40 mm Wall Thickness made of Alloy 625

60 Layer - GMAW

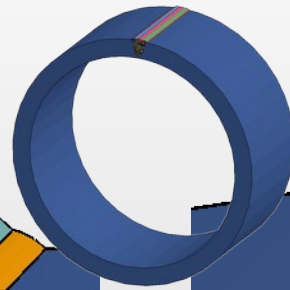
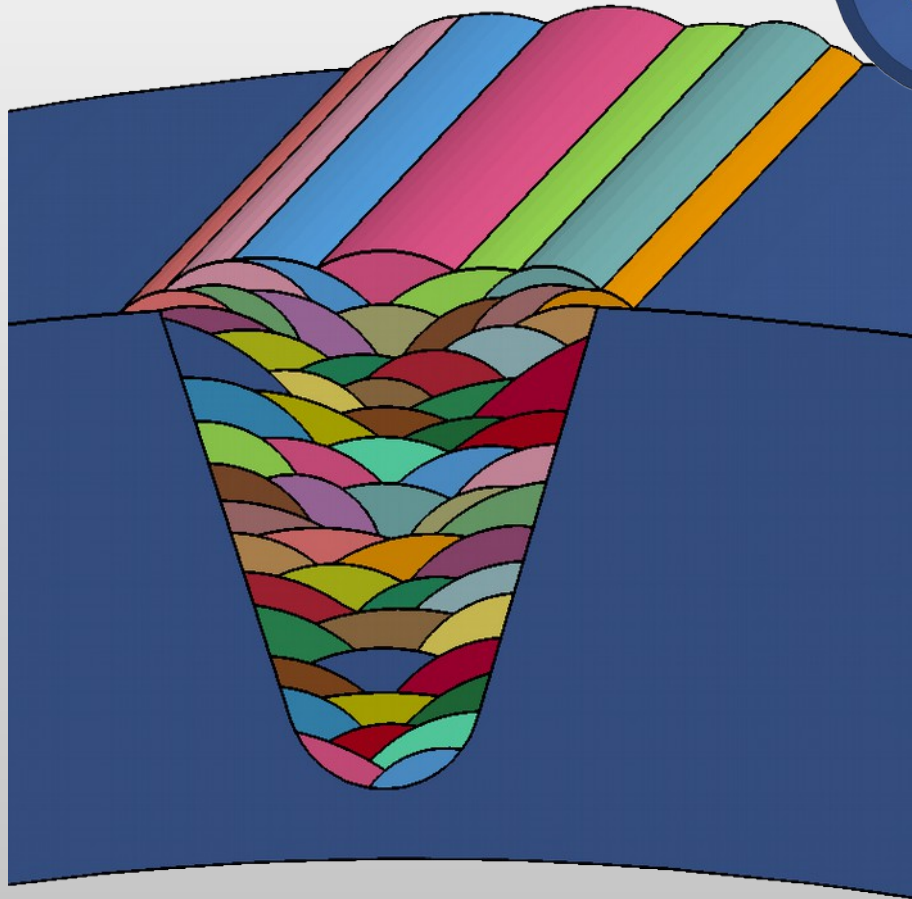

93 Layer - TIG

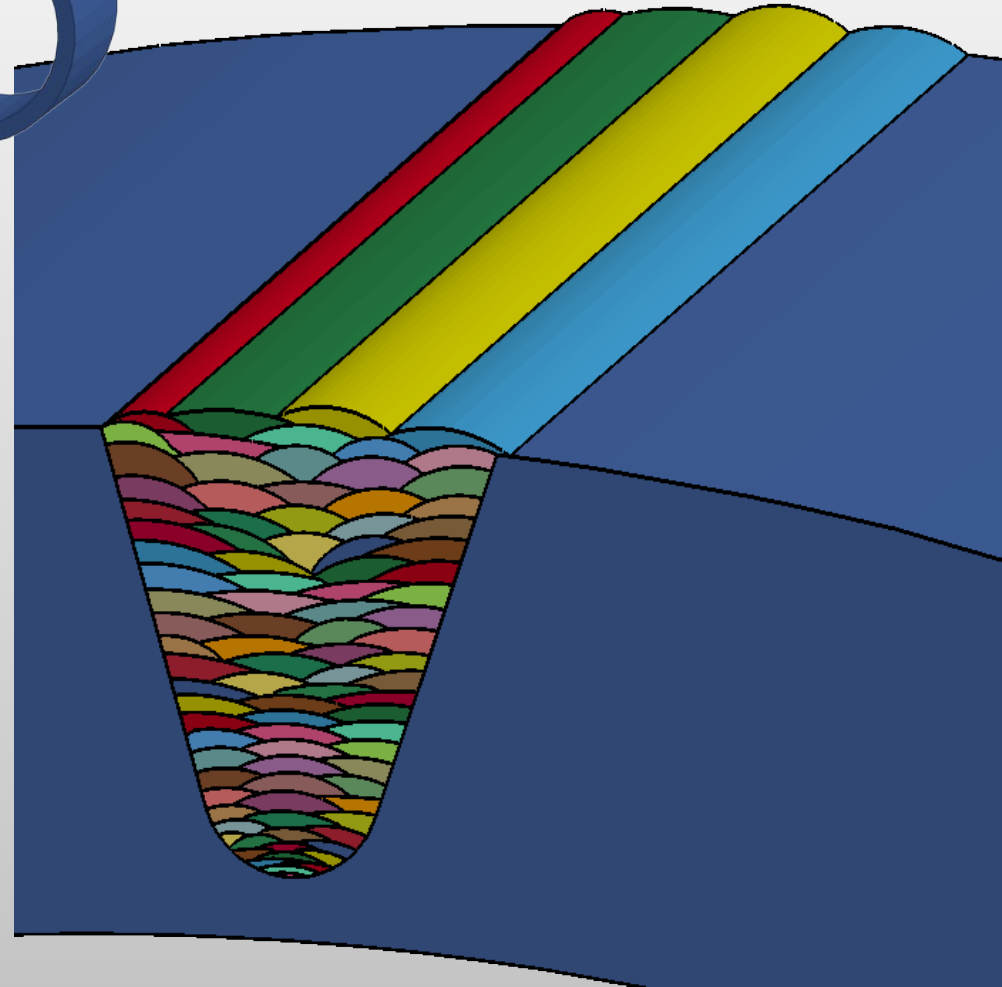

Weld of a Pipe with 40 mm Wall Thickness made of Alloy 625 - 60 Layer GMAW

MSG
Time = 26425

Temperature Layer 44

Equivalent Plastic Strain

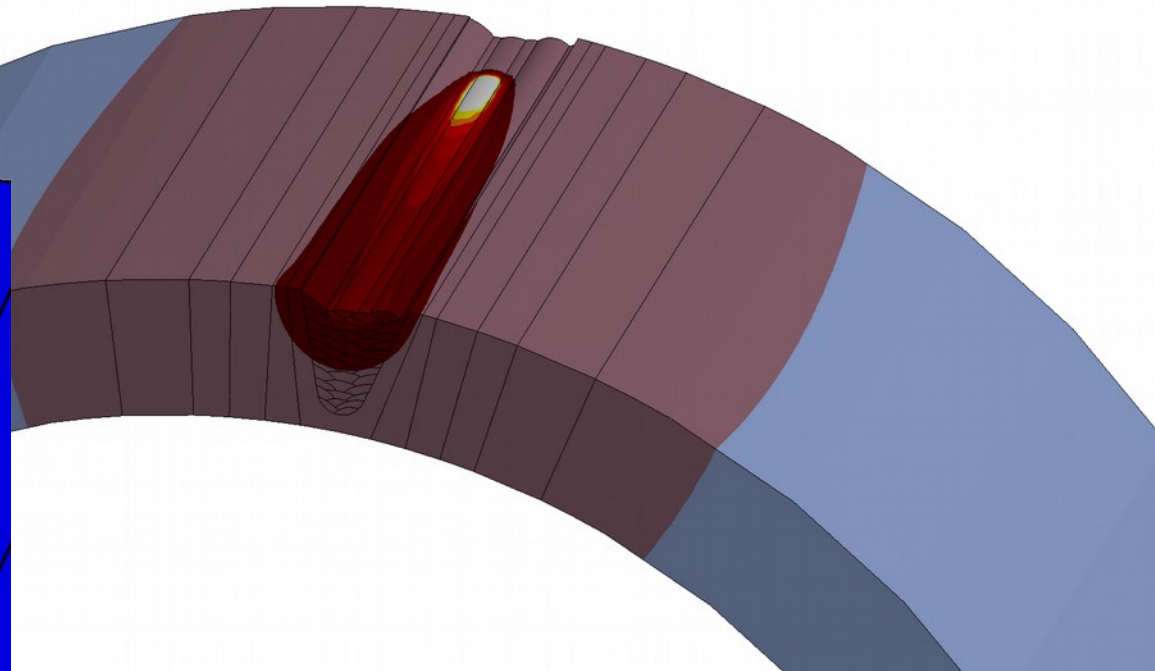
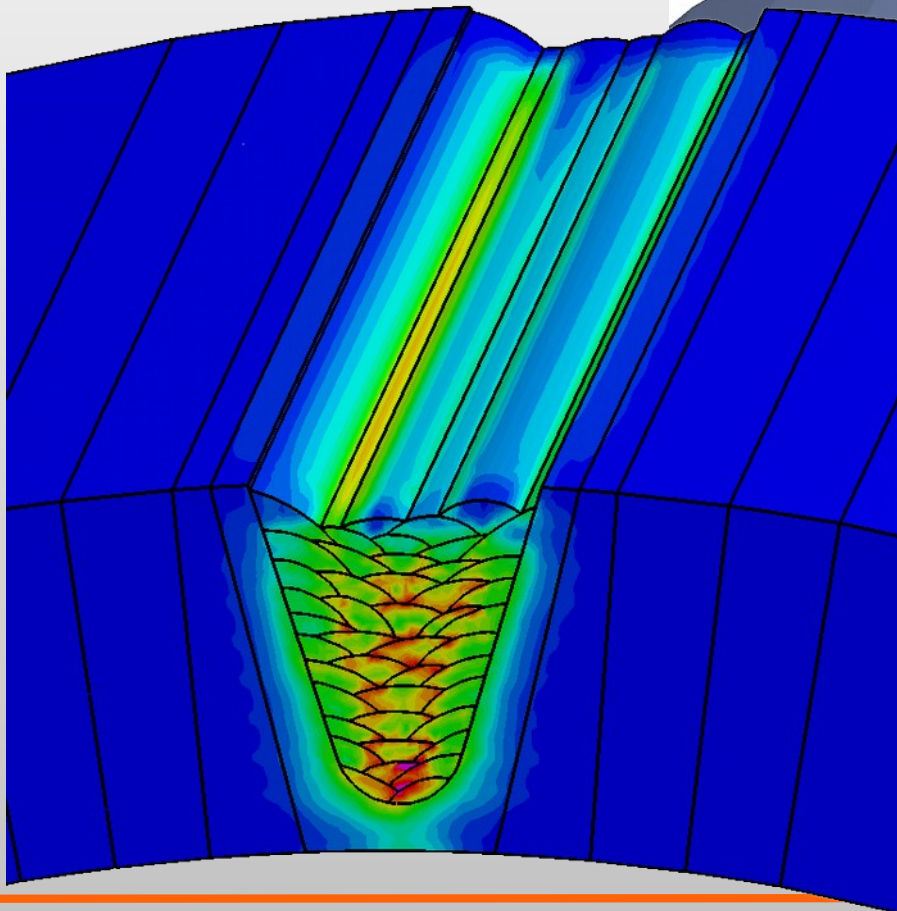

Temperature Field Multilayered Weld 2D Metatransient

MSG

Time = 35401, #nodes=3630, #elem=1867

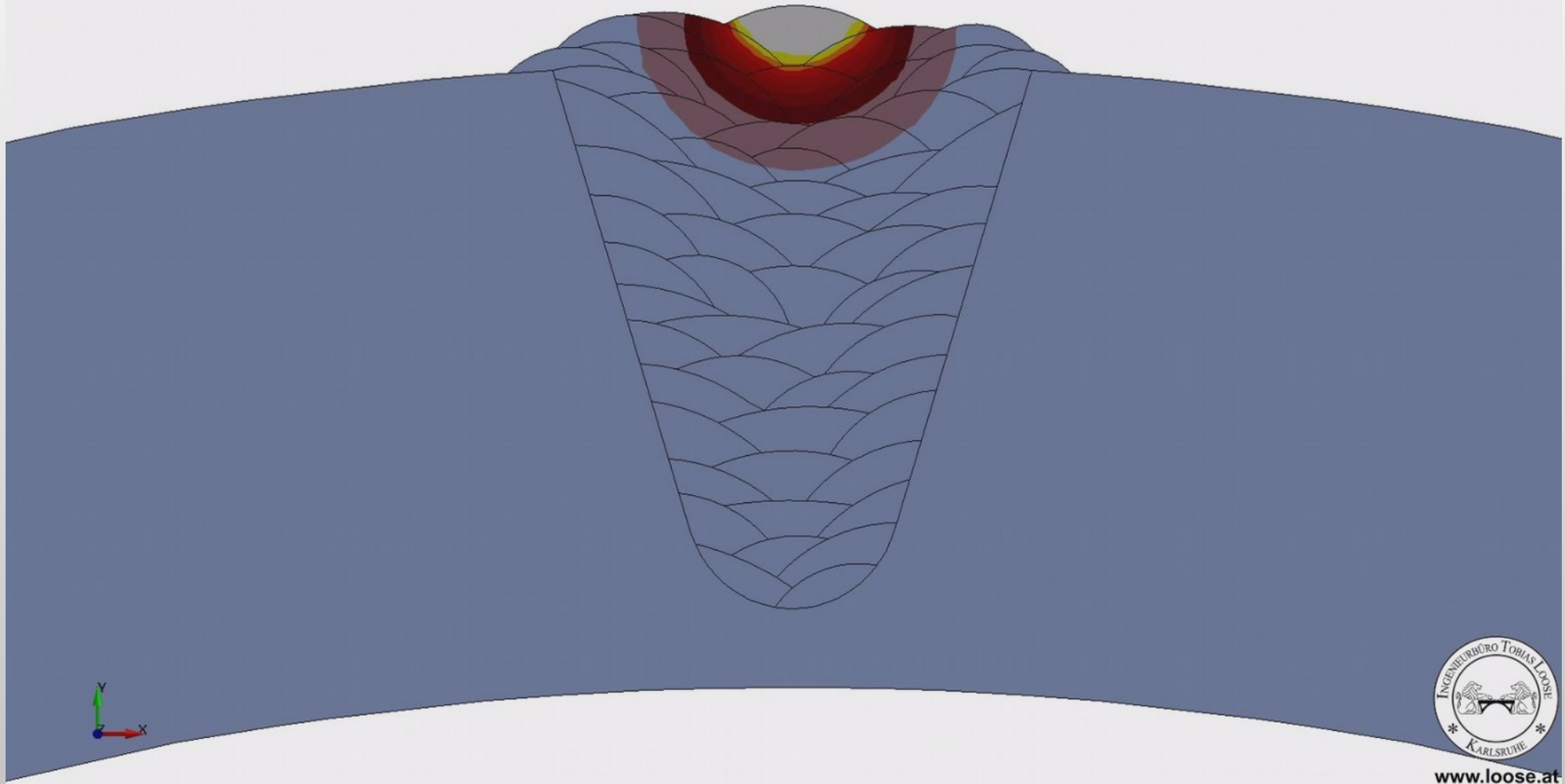

Multilayered Weld T-Joint with large Plate Thickness

2D-Analysis LS-DYNA

2D plain strain

Plate: 300 x 80 mm

Stiffner: 150 x 24 mm

Fillet Weld: a = 13 mm

Material: 1.4301

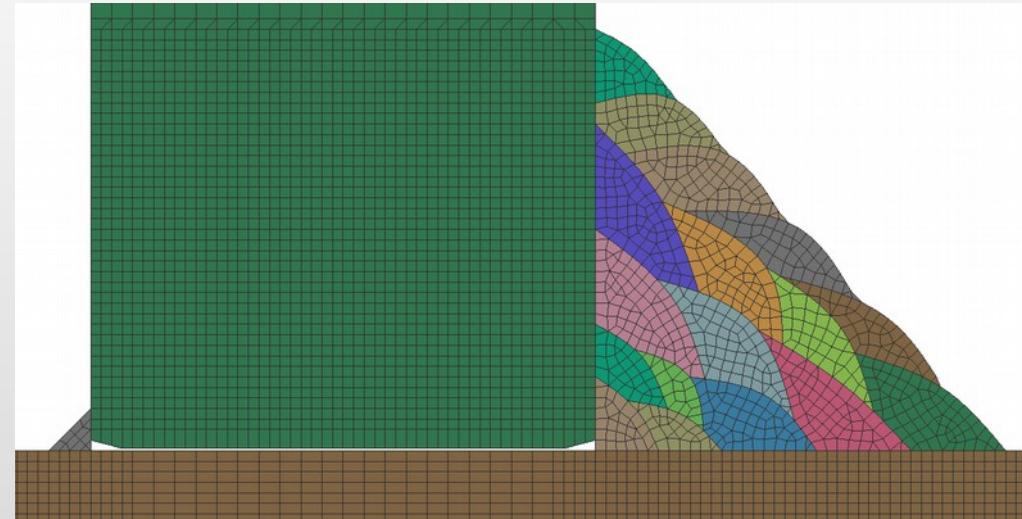

Tack a = 1,4 mm

with failure on strain $K_{FAIL} = 0,25$ m/m

**Initial gap between stiffner and plate:
0,1 mm**

Symmetry boundary conditions on left and right side.

Multilayered Weld T-Joint with large Plate Thickness 2D-Analysis LS-DYNA – plastic strain

T2D
Time = 2409.7
Contours of Effective Plastic Strain

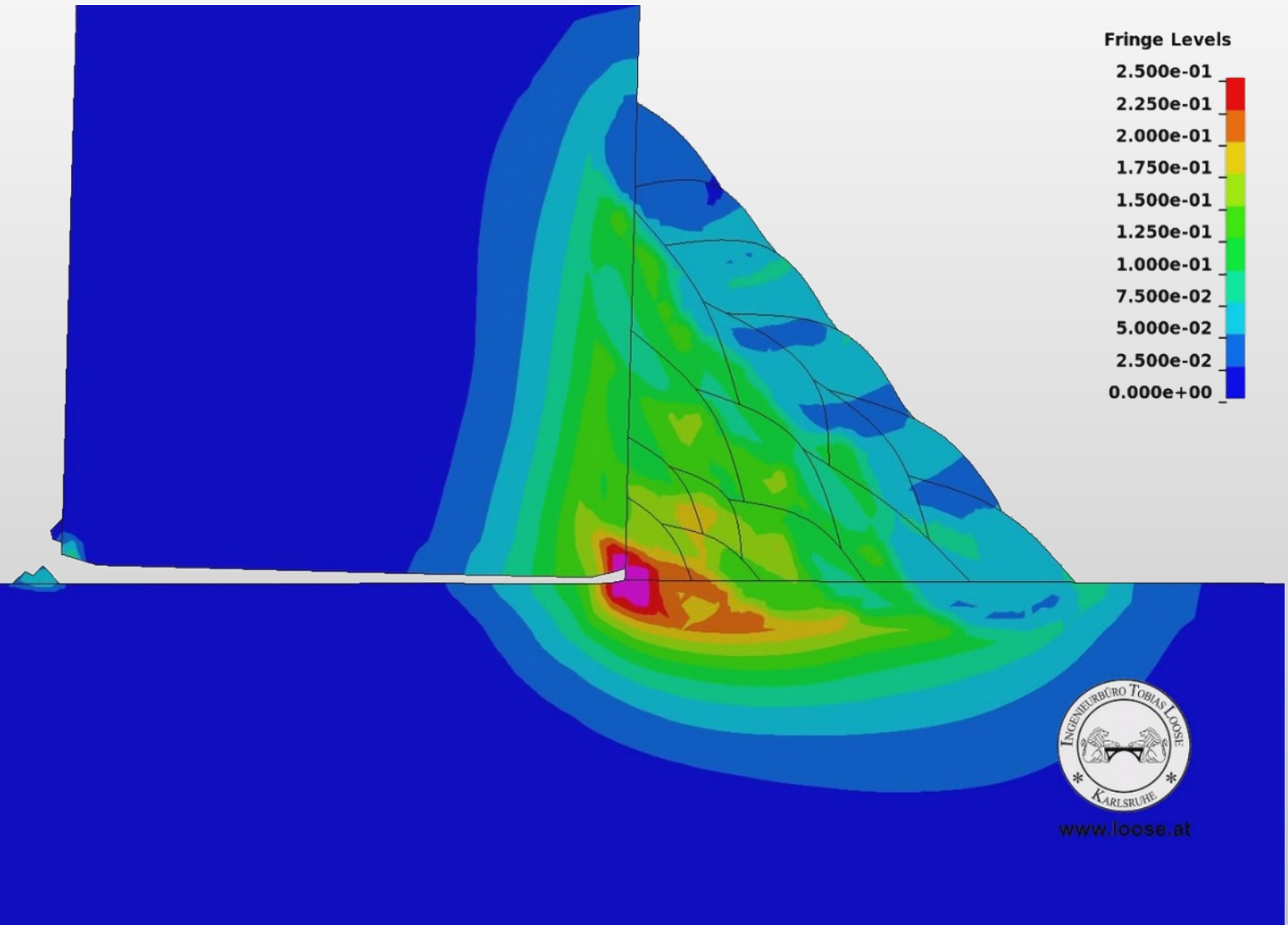

Prediction of Weld Quality

Microstructure and Mechanical Properties

Material Specification
Chemical Composition

WeldWare®



S355

- Weld-Pool
- HAZ
- Microstructure
- Yield Strength
- Ultimate Strength
- Hardness
- Ultimate Elongation

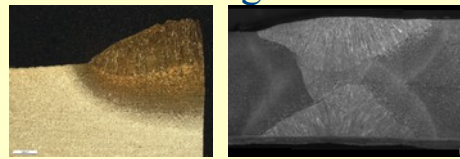
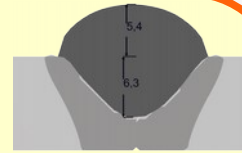

WPS
Welding Procedure Specification

SimWeld®

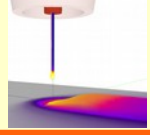

S690

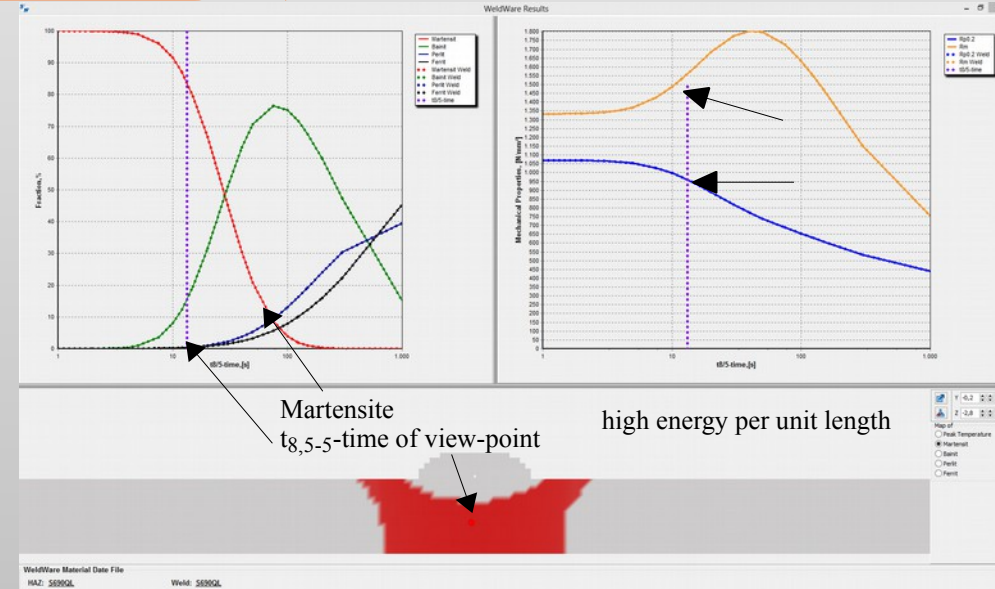
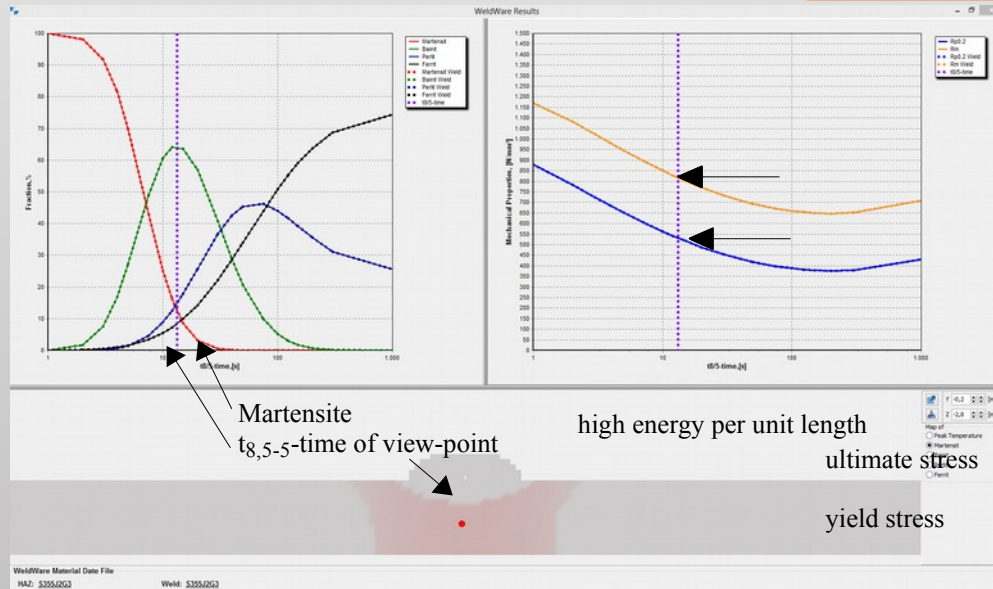

Quenching

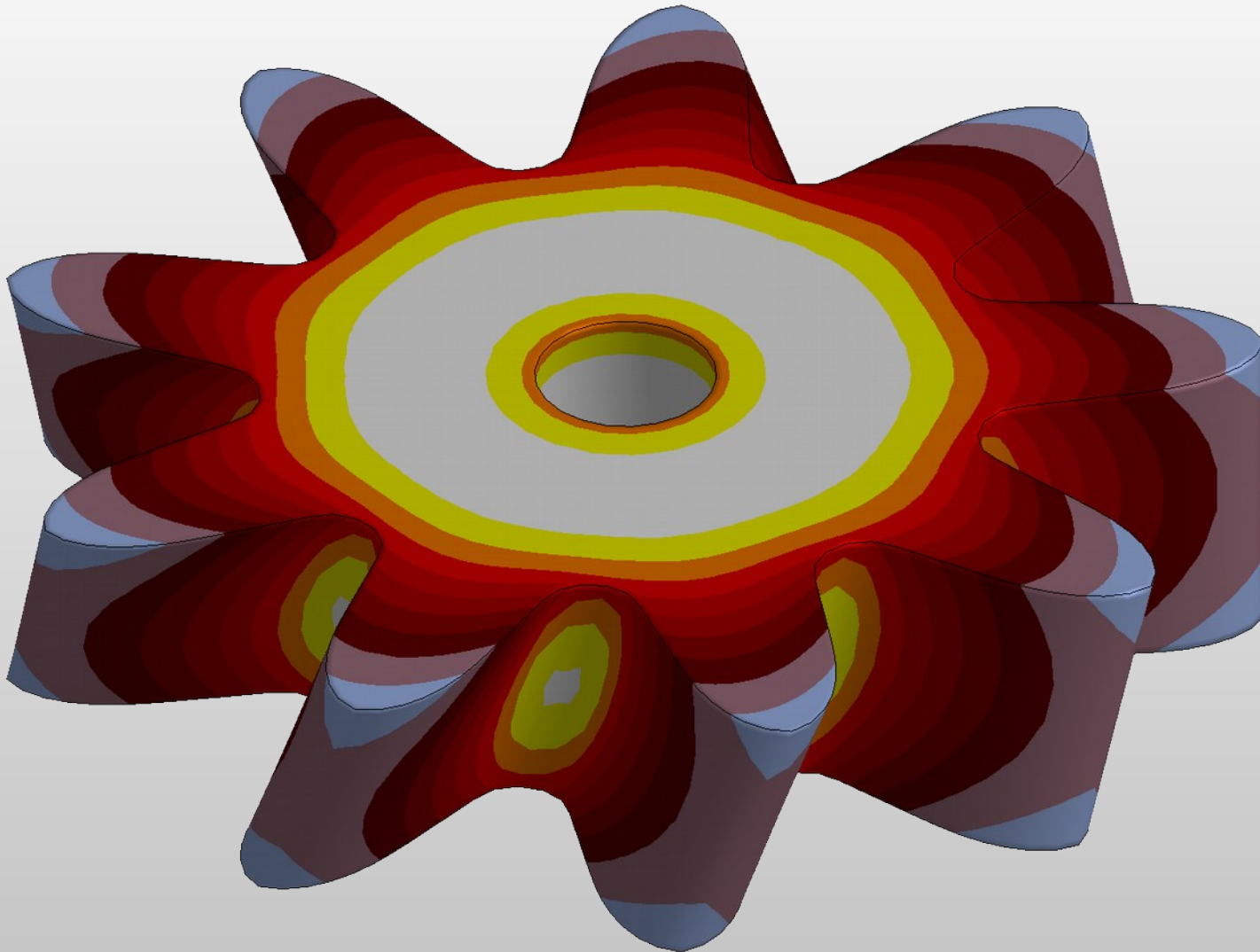



Quenching of a Gear made of S355

Temperature Curve

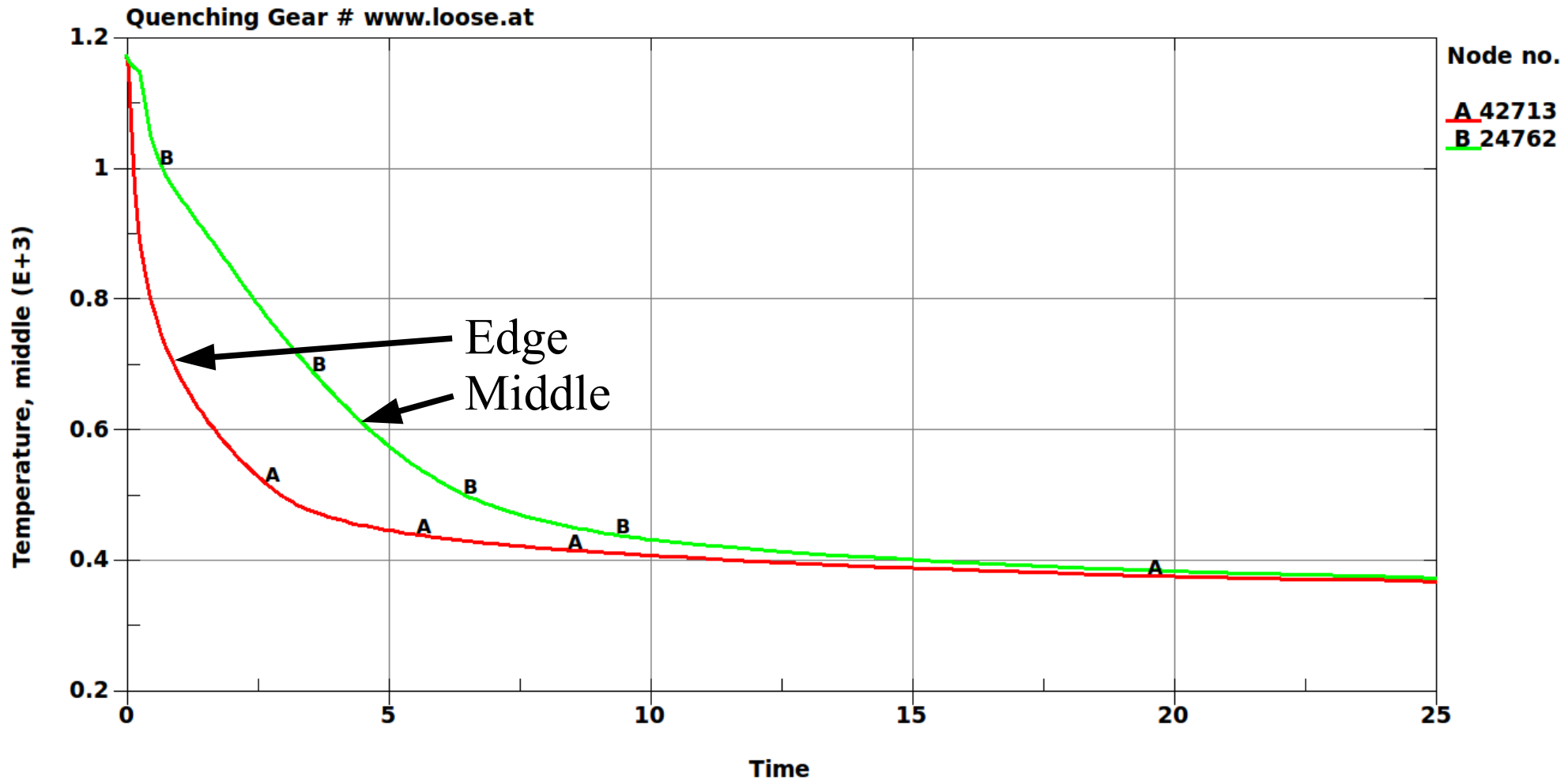

Quenching of a Gear made of S355

Results of Heat Treatment Simulation

Martensit (right)

Hardness HV (bottom left)

Yield (bottom right)

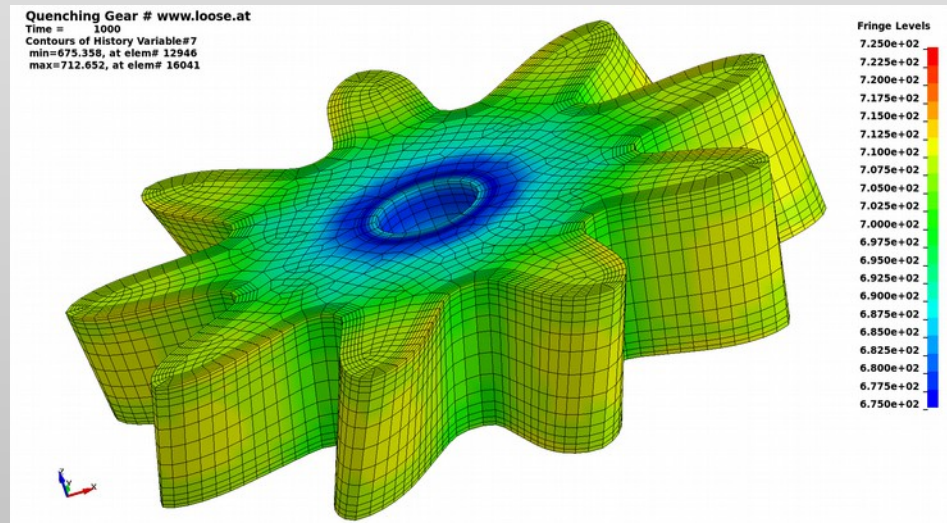
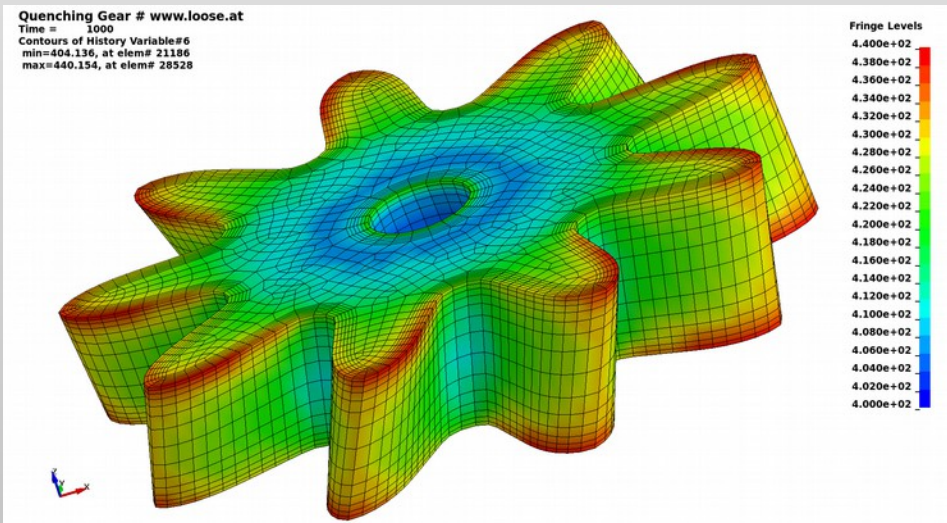
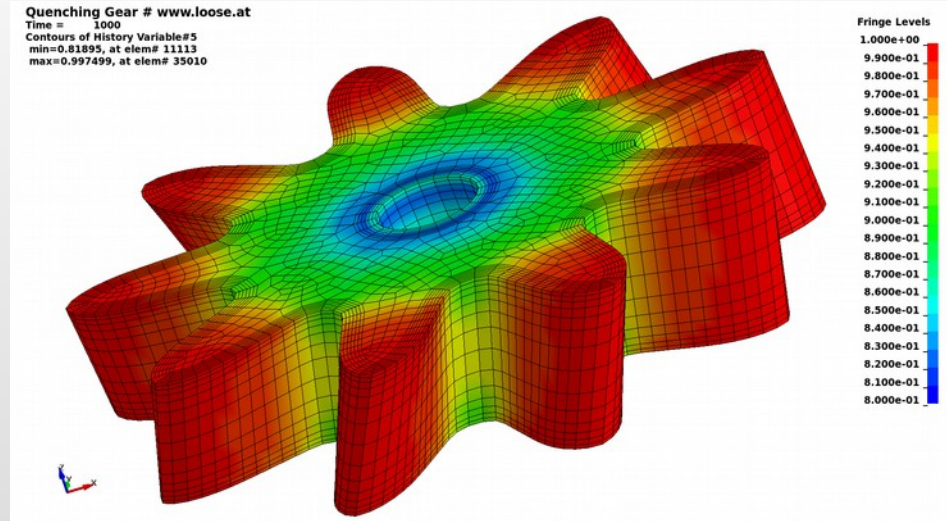

Validation

IIW Round Robin Versuch

- Plate with the dimensions 270 x 200 x 30 mm³ with V/U-shaped notch
- Austenitic stainless steel (316LNSPH, Re = 275 MPa)
- 2 Layer welding of the notch with same material: 316L
- TIG Welding with U = 9 V, I = 155 A, v = 0,67 mm/s

Mesured and calculated results

Longitudinal residual stresses

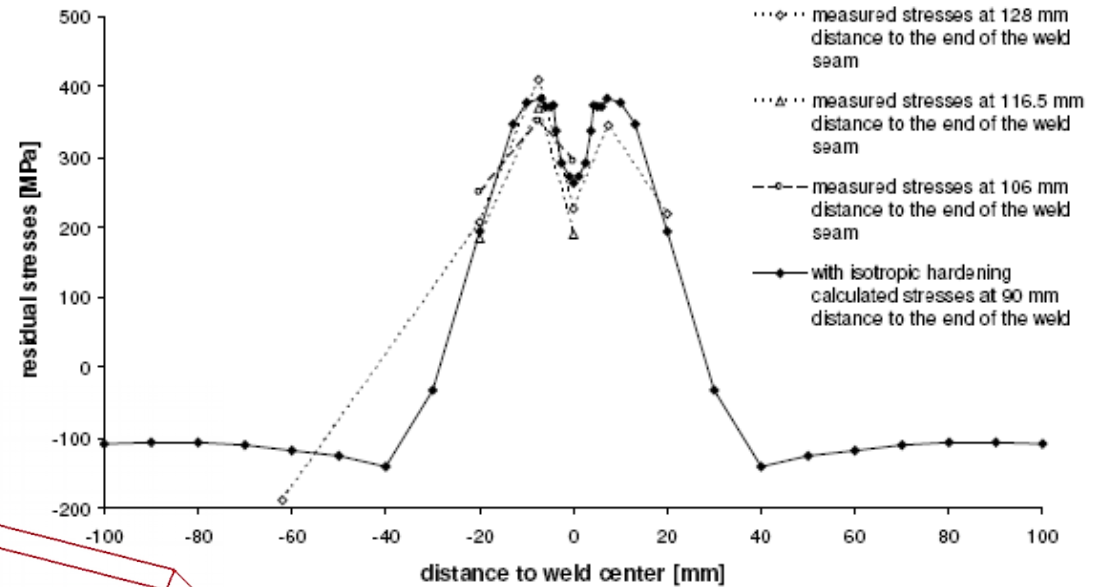
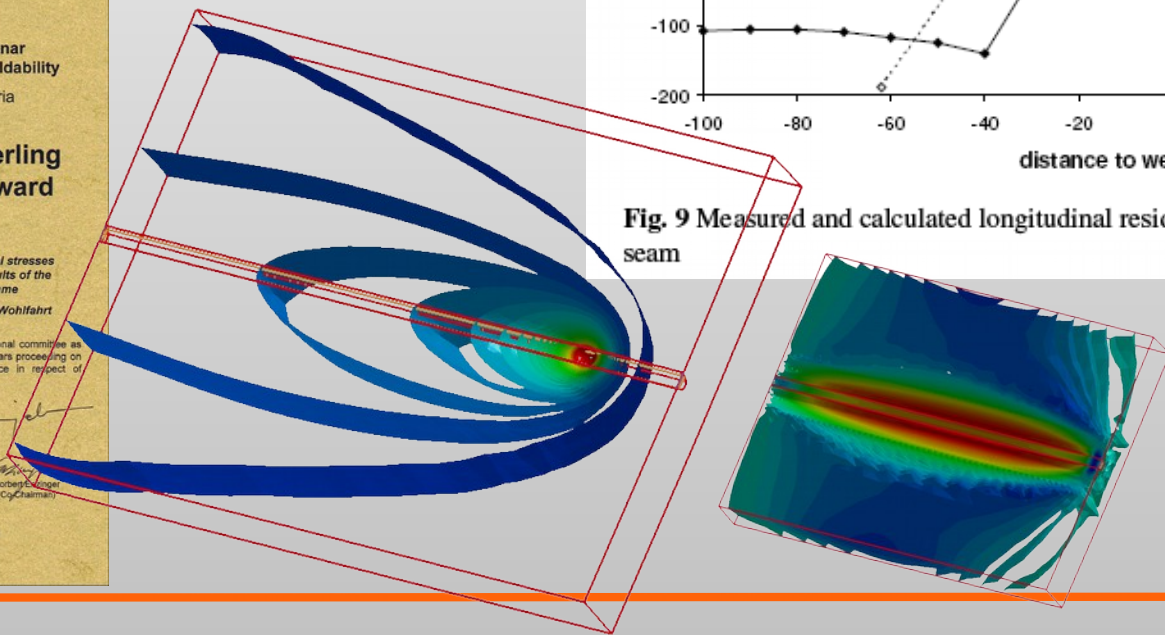

Fig. 9 Measured and calculated longitudinal residual stresses along a line transverse to the weld seam



Loose, T. ; Sakkietitbutra, J. ; Wohlfahrt, H. :
 New 3D-Calculations of residual stresses
 consistent with measured results of the
 IIW Round Robin Programme.
 In: Cherjak, H. (Ed.) ; Enzinger, N. (Ed.) :
 Mathematical Modelling of Weld Phenomena Bd. 9,
 Verlag der Technischen Universität Graz, 2010



Validation

IIW Round Robin Versuch

Transversal Stress

Longitudinal Stress

SYSWELD

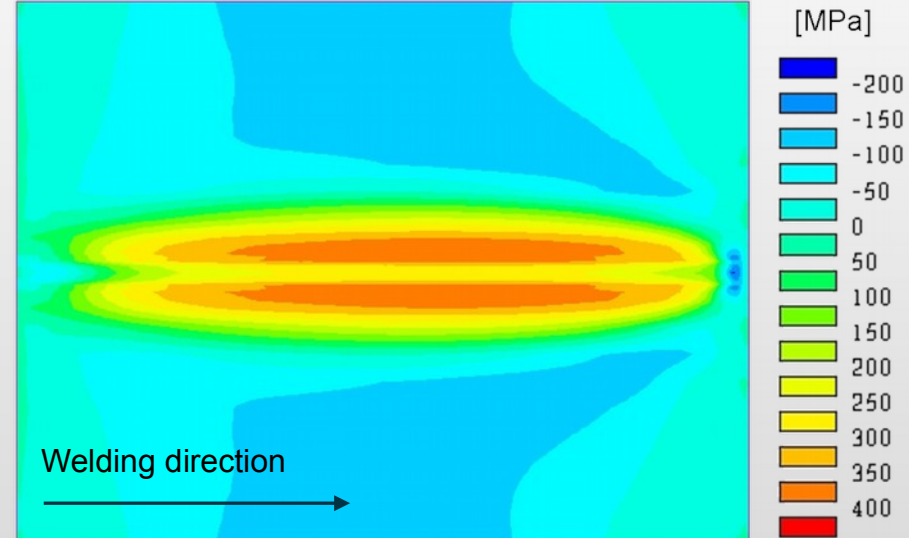
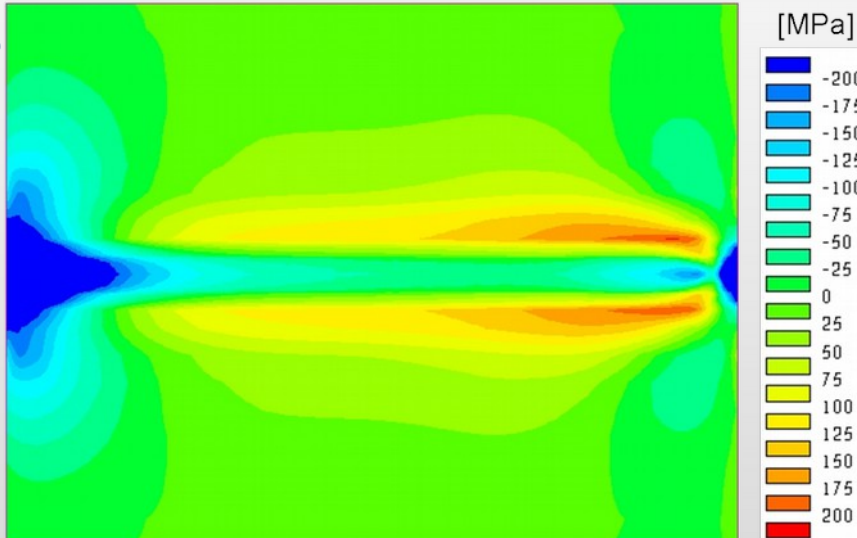

Round Robin
Time = 15000
Contours of Z-stress
min=-445.209, at elem# 286
max=352.951, at elem# 36458

LS-DYNA

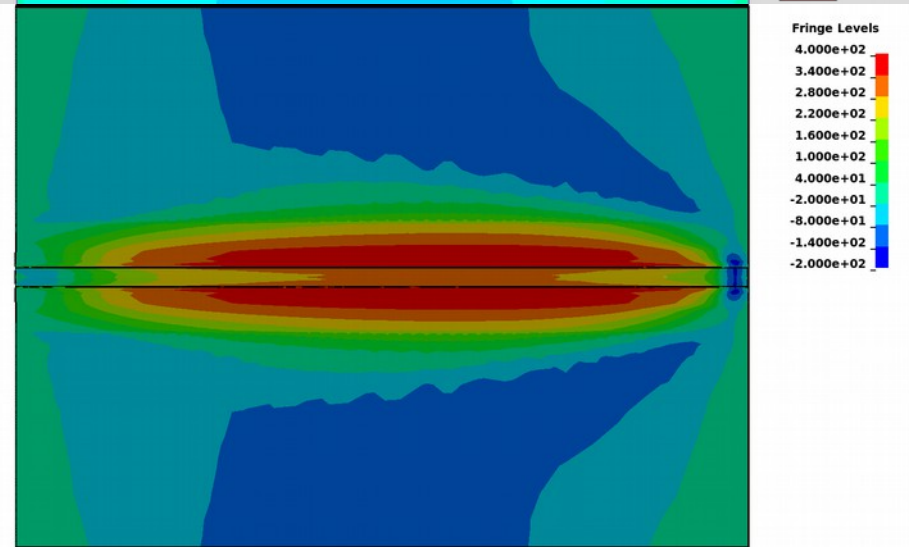
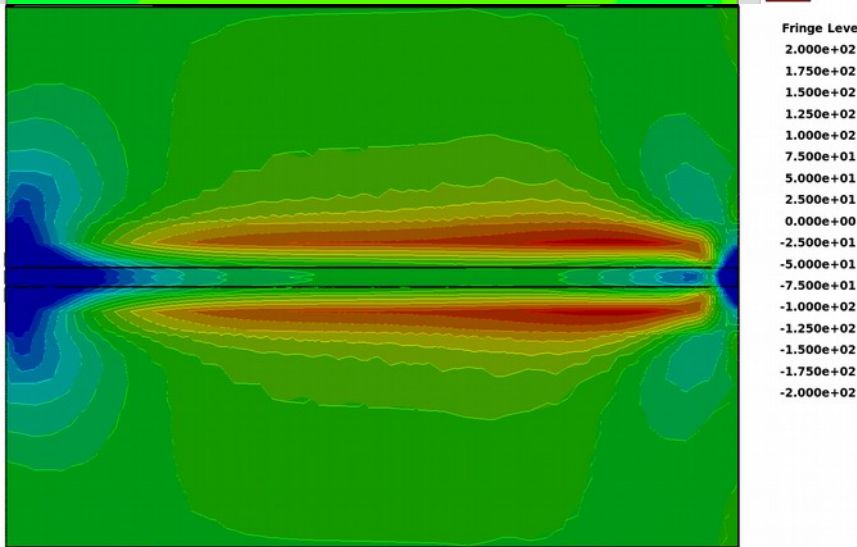

Validation Nitschke-Pagel Test

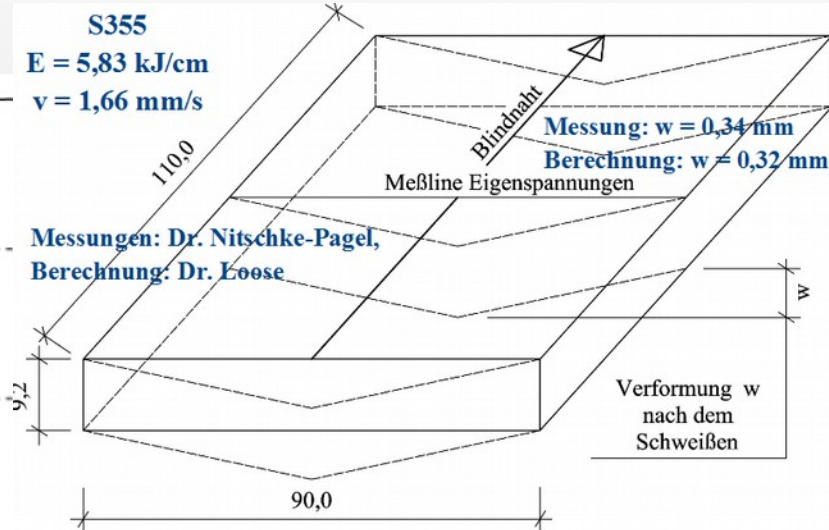
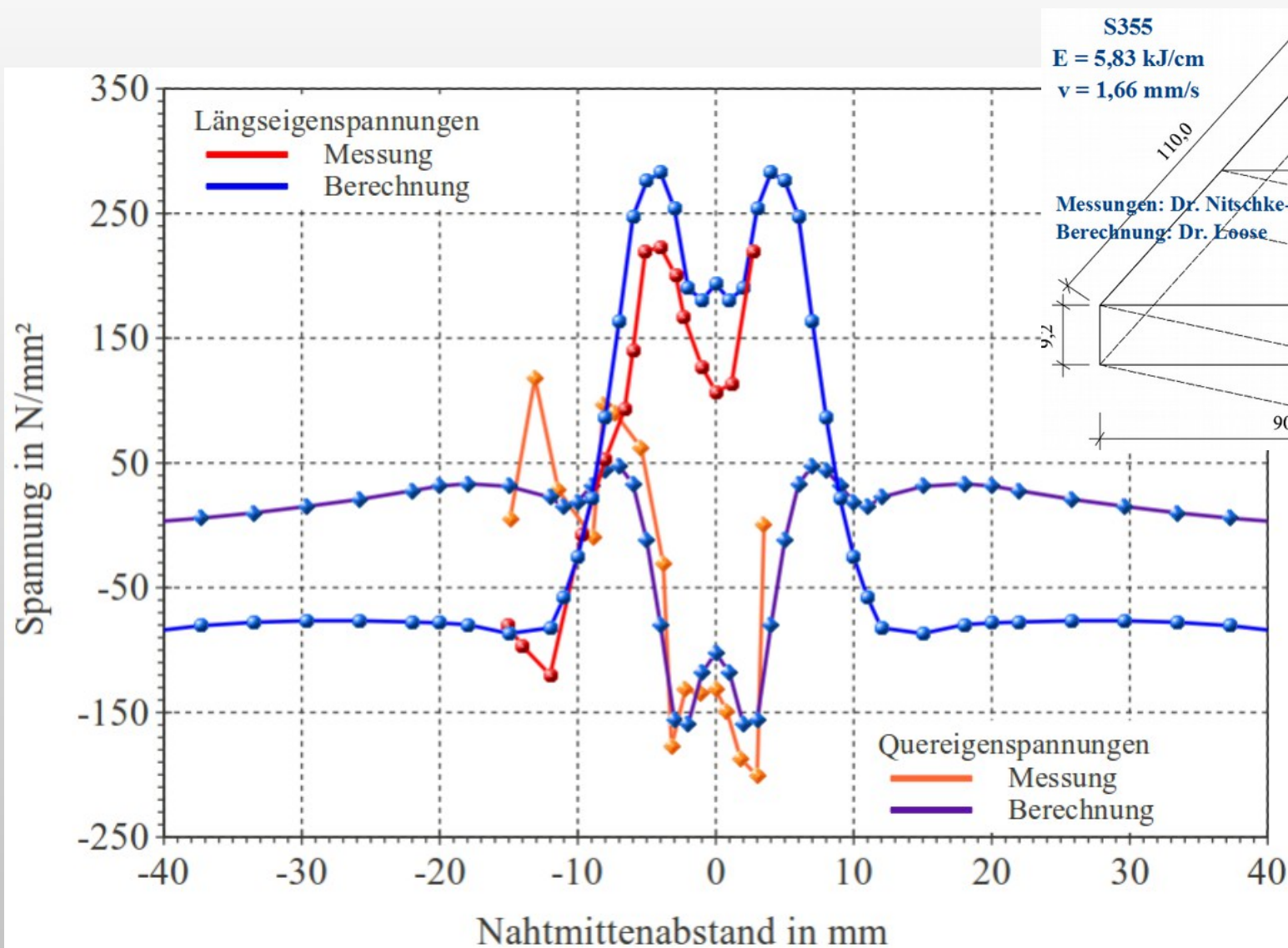

Distortion w :

- Experiment: 0,34 mm
- Sysweld: 0,32 mm
- LS-DYNA: 0,34 mm

Loose, T.: Einfluß des transienten Schweißvorganges auf Verzug, Eigenspannungen und Stabilitätsverhalten axial gedrückter Kreiszyinderschalen aus Stahl, Diss, Karlsruhe, 2008

Makrosection

Temperature: 100 .. 1500 °C

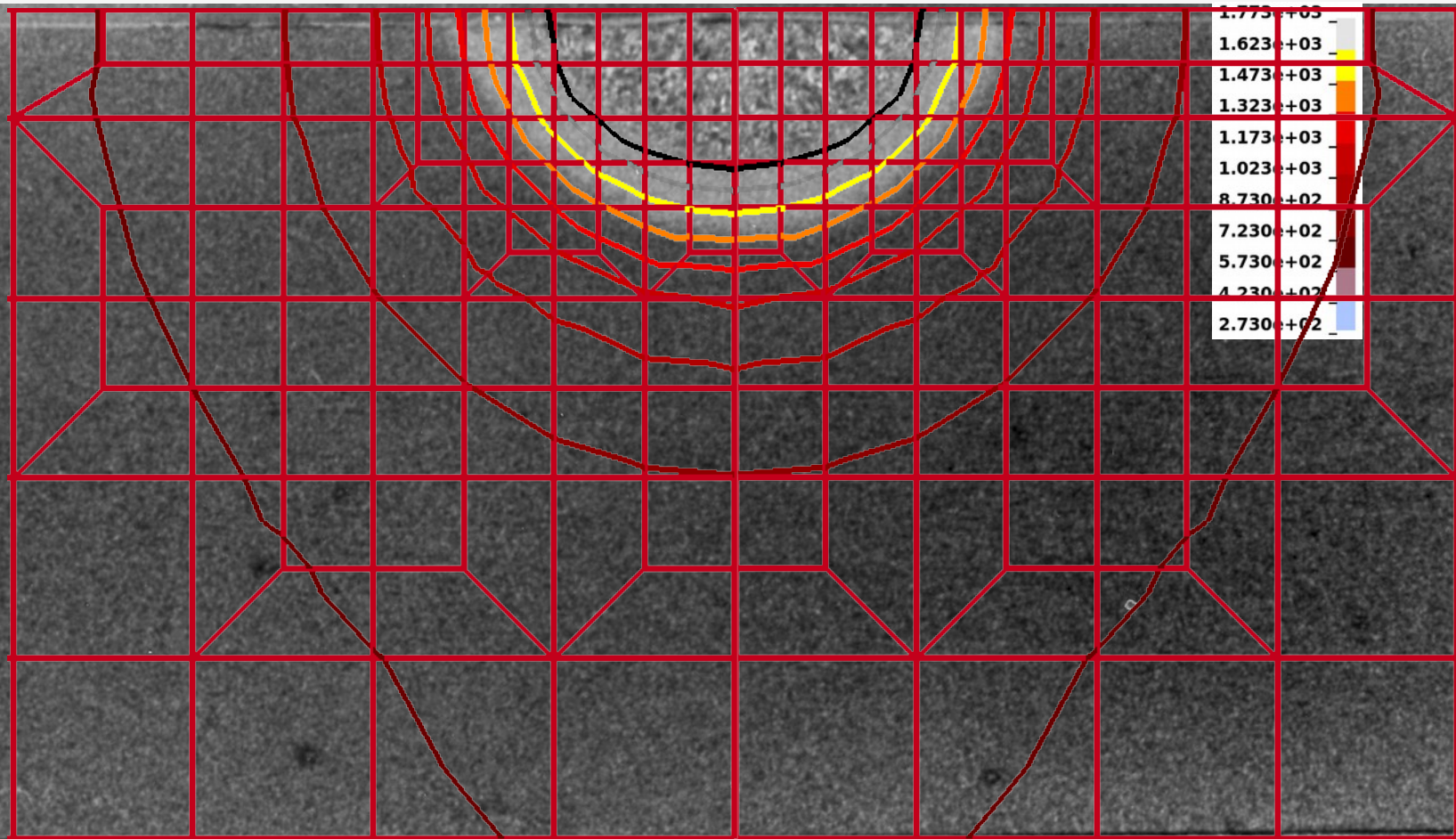

Result

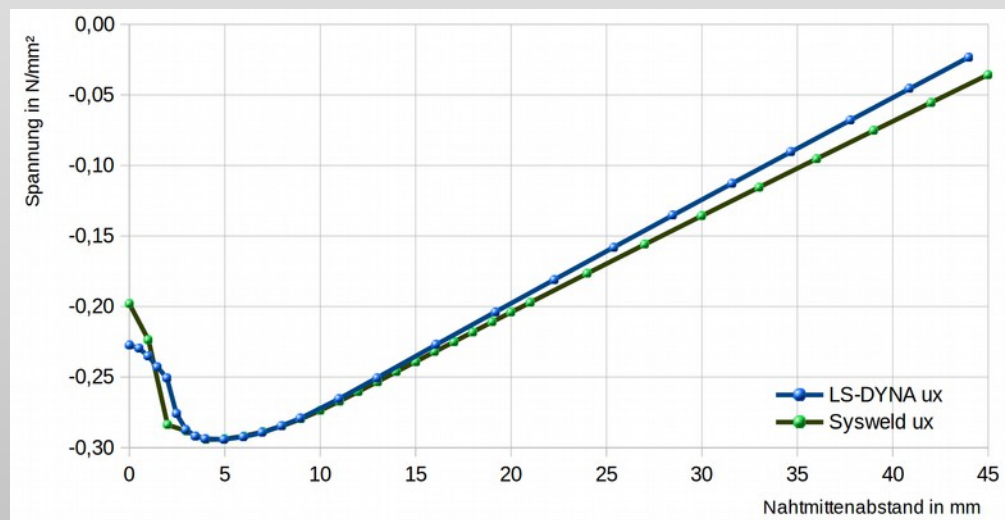
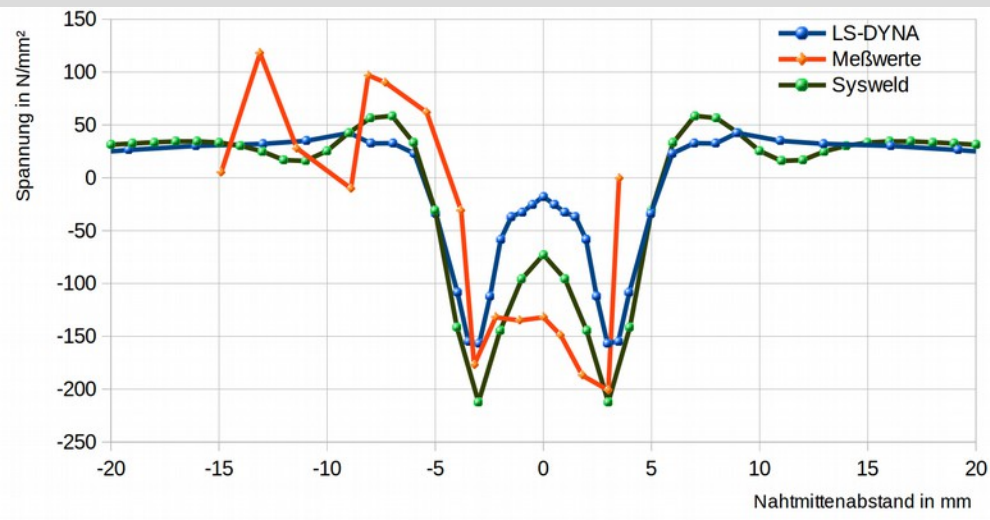
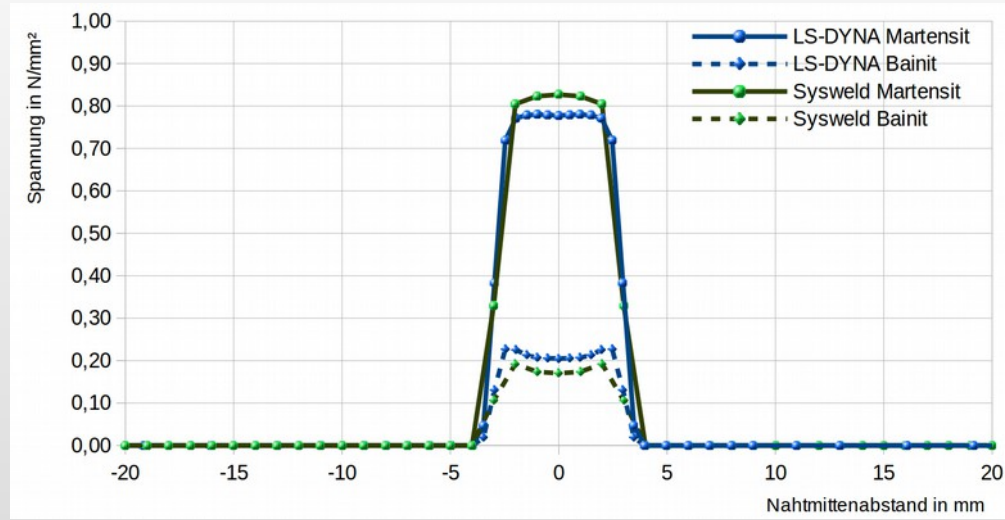
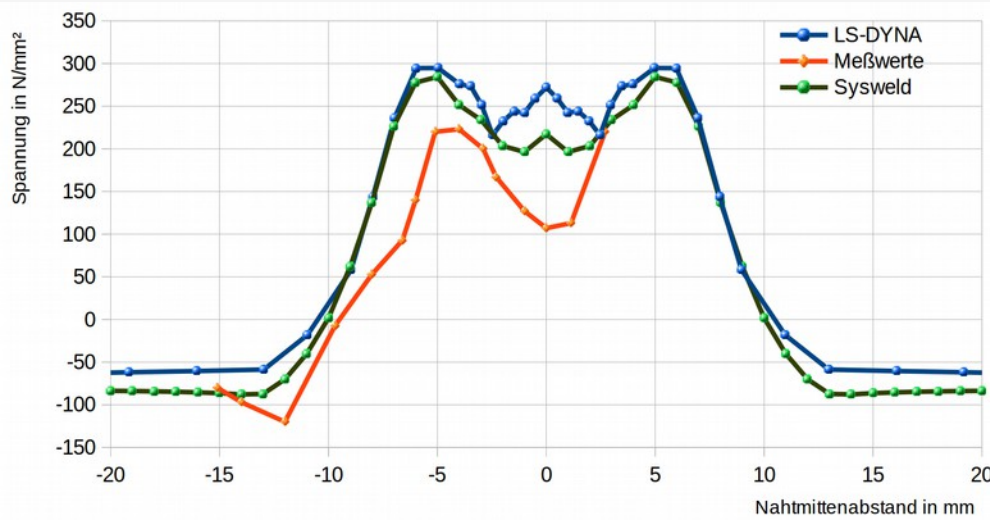

Benefits

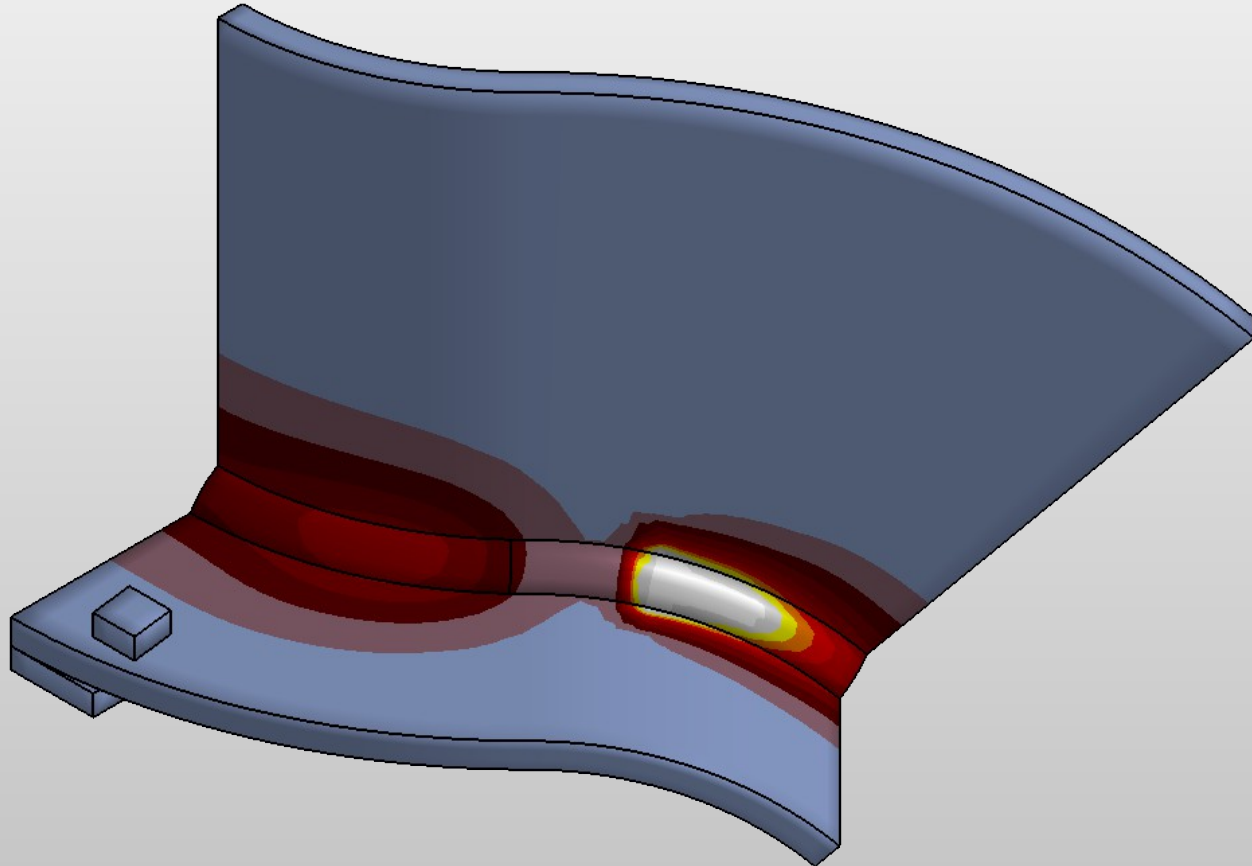



Results from Simulation of Welding and Heat Treatment

- Process simulation welding (SimWeld)
 - weld pool formation
 - heat input / heat generation
 - local temperature field, cooling time in the weld and heat affected zone
- Structure simulation welding (DynaWeld)
 - temperature field in the whole assembly during welding, cooling time
 - distortion during welding and cooling
 - clamping forces and bearing reactions
 - plastic strains, strain hardening
 - residual stresses, elastic or plastic reserves
 - microstructure / areas with change of microstructure
- Heat treatment simulation
 - temperature during quenching
 - carburization and depth of arburization for case hardening
 - microstructure and hardness
 - distortion / distortion after hardening



Benefits from Simulation of Welding and Heat Treatment

- Adjustment of Process Parameter
- Design of Geometrie
 - optimization of geometry concerning acceptable distortions
 - determination of invers distorted geometry for the design of forming
 - design of gap for laser welding
- Heat Management
 - preheating temperature, intermediate temperature
 - design of desired microstructure
- Design of Clamps
 - predeformation
 - clamp forces
- Design of the Order of the Welds
- Observation of the State of Stresses
 - prestressed zones / tension zones
 - delimitation of plastic strain
- Special Tasks ...

More Benefits of Welding and Heat Treatment Simulation

- Simulation is available in early stage of design.
- Simulation is available without any fabrication place.
- Simulation is helpful for the analysis of damages.
- Simulation helps to understand the process and its events.
- Simulation is helpful for education and training
- Welding and heat treatment simulation provides the state of the assembly for further simulation analyses.

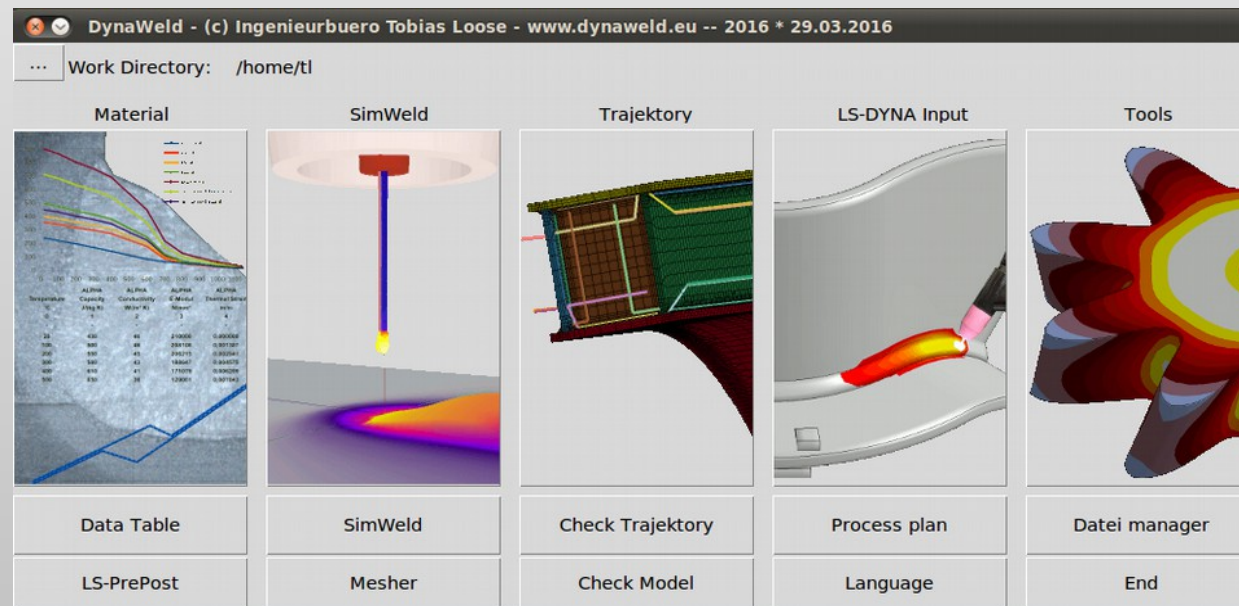

Material

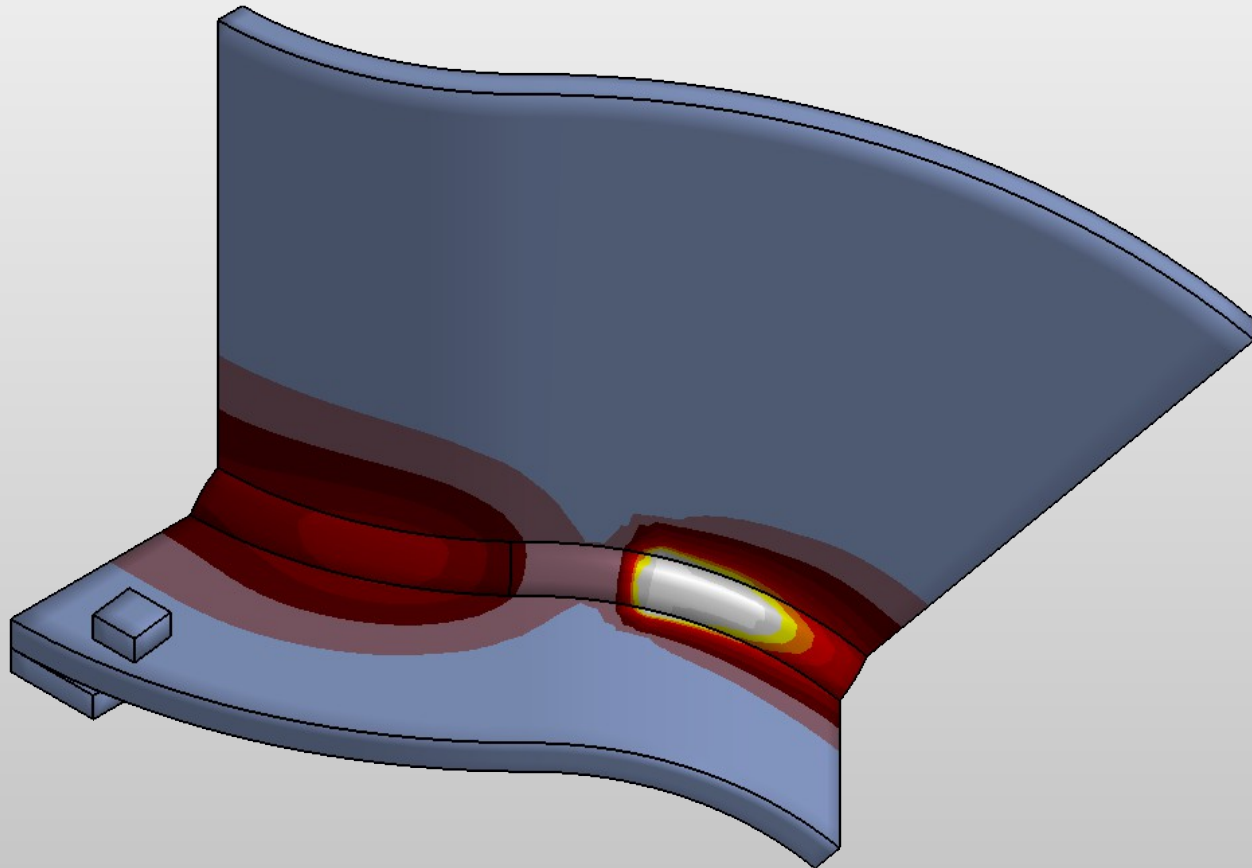



Sources of Material Data for Welding and Heat Treatment

- Experiment
 - Execution of tests
- References
 - Papers with test results for material data
 - Material data sheet
- Software / Material Simulation
 - WeldWare[®]
 - JMatPro
 - MatCalc

Depending on Temperature

Elasticity-Modul

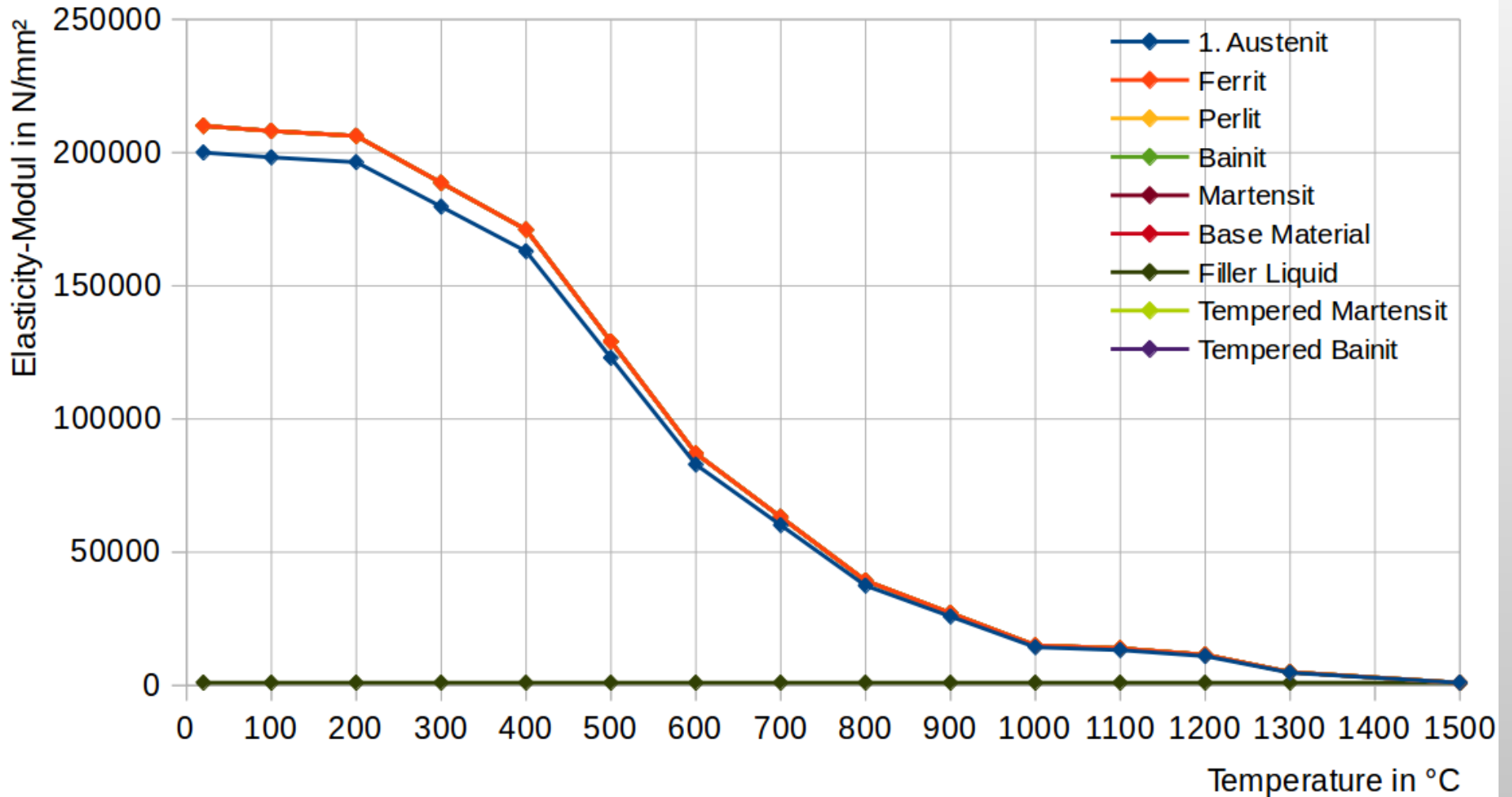

Depending on Microstructure

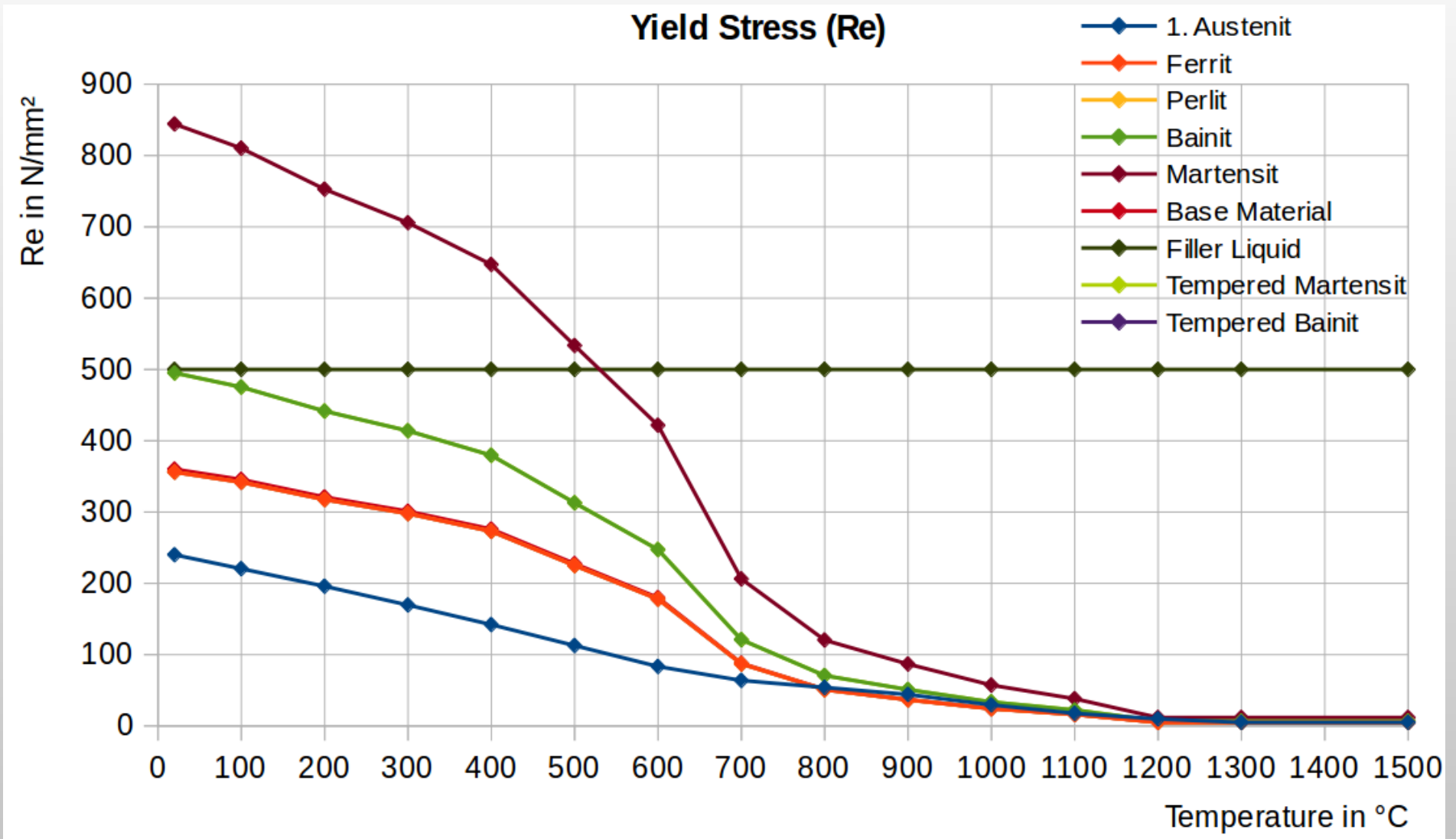

Description of phase transformation (ZTU, ZTA)

CCT-Data
WeldWare®

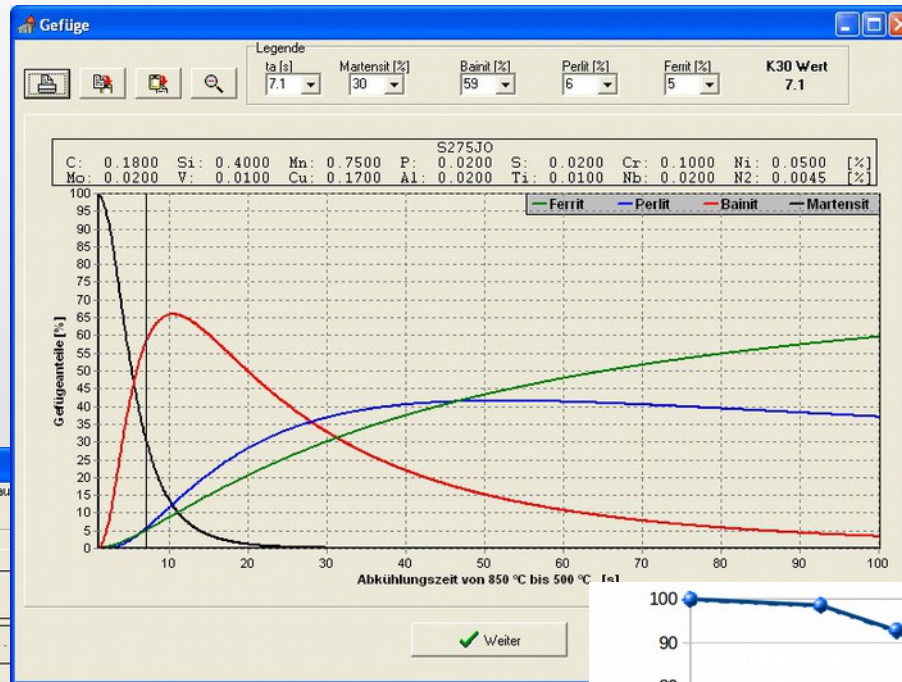

Microstructure
Simulation with
LS-DYNA *MAT_254

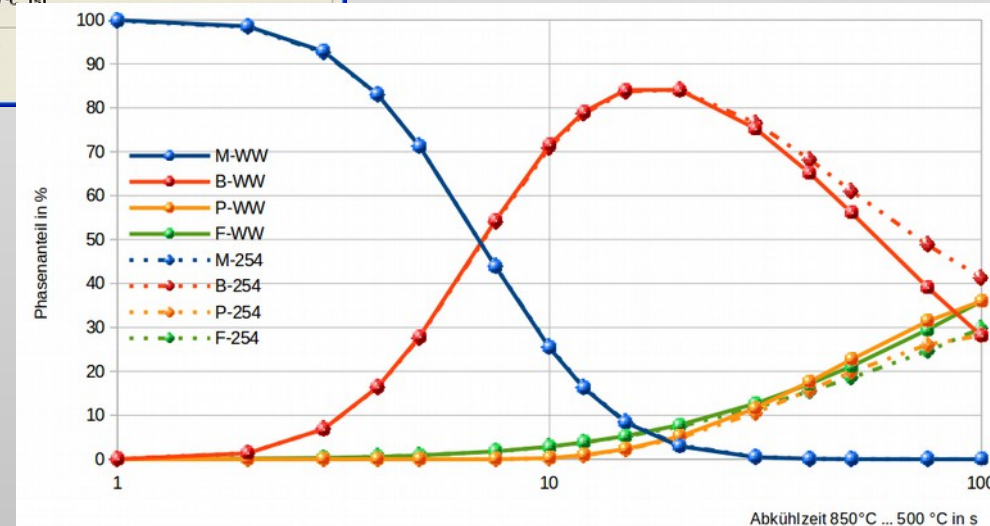
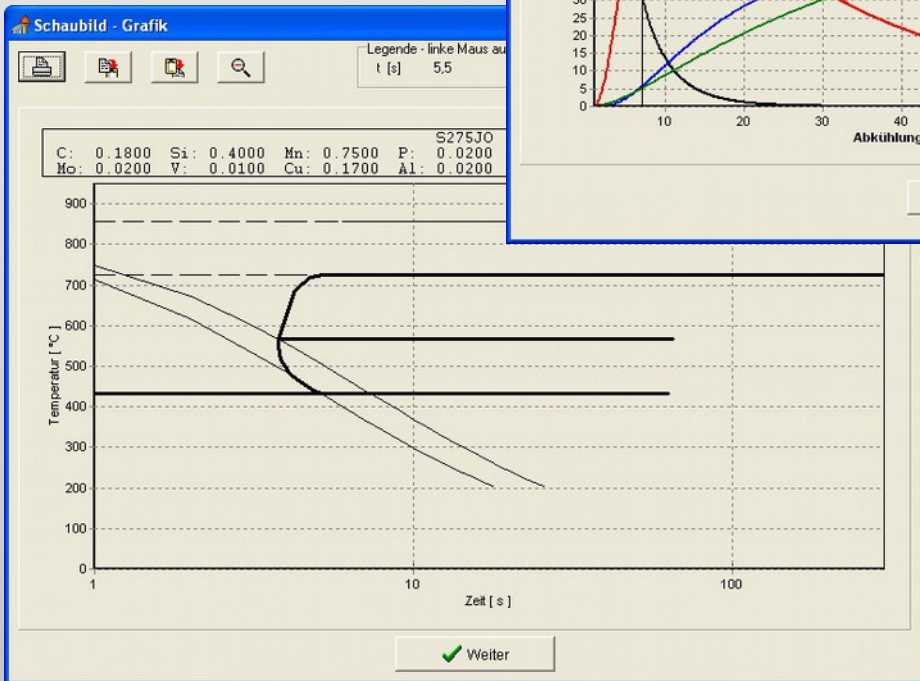

Thermal strain

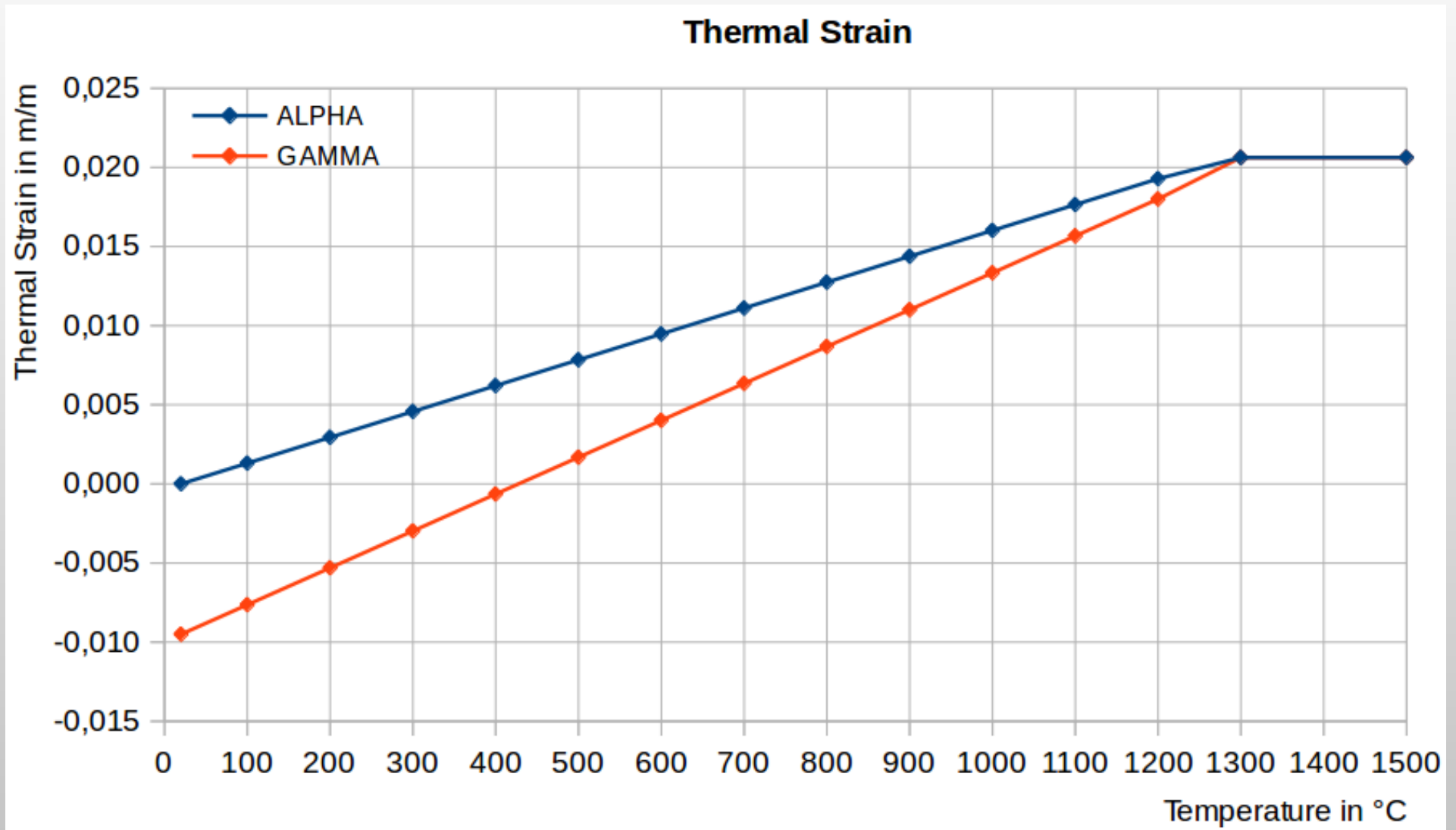

Transformation effects

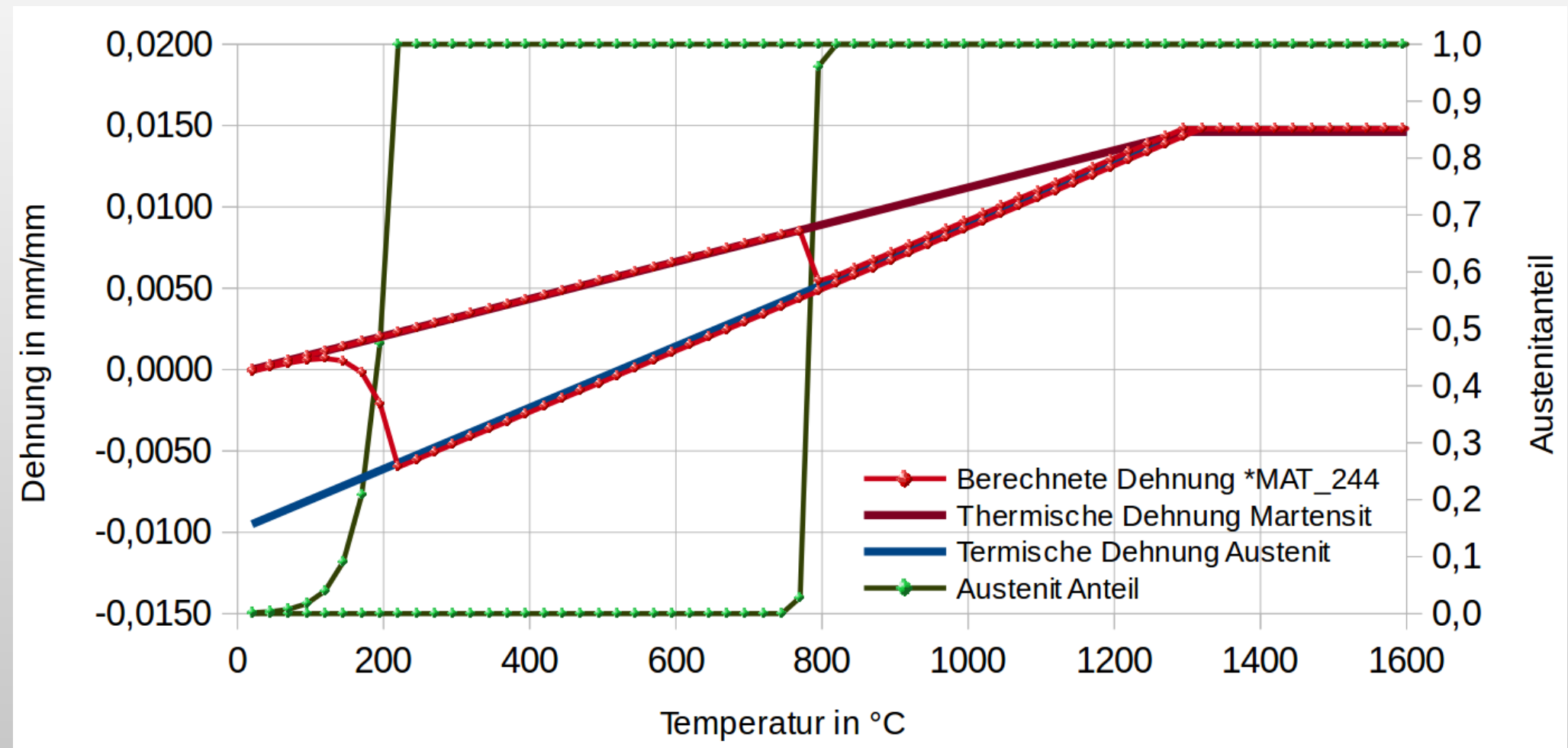

Simplified Approach

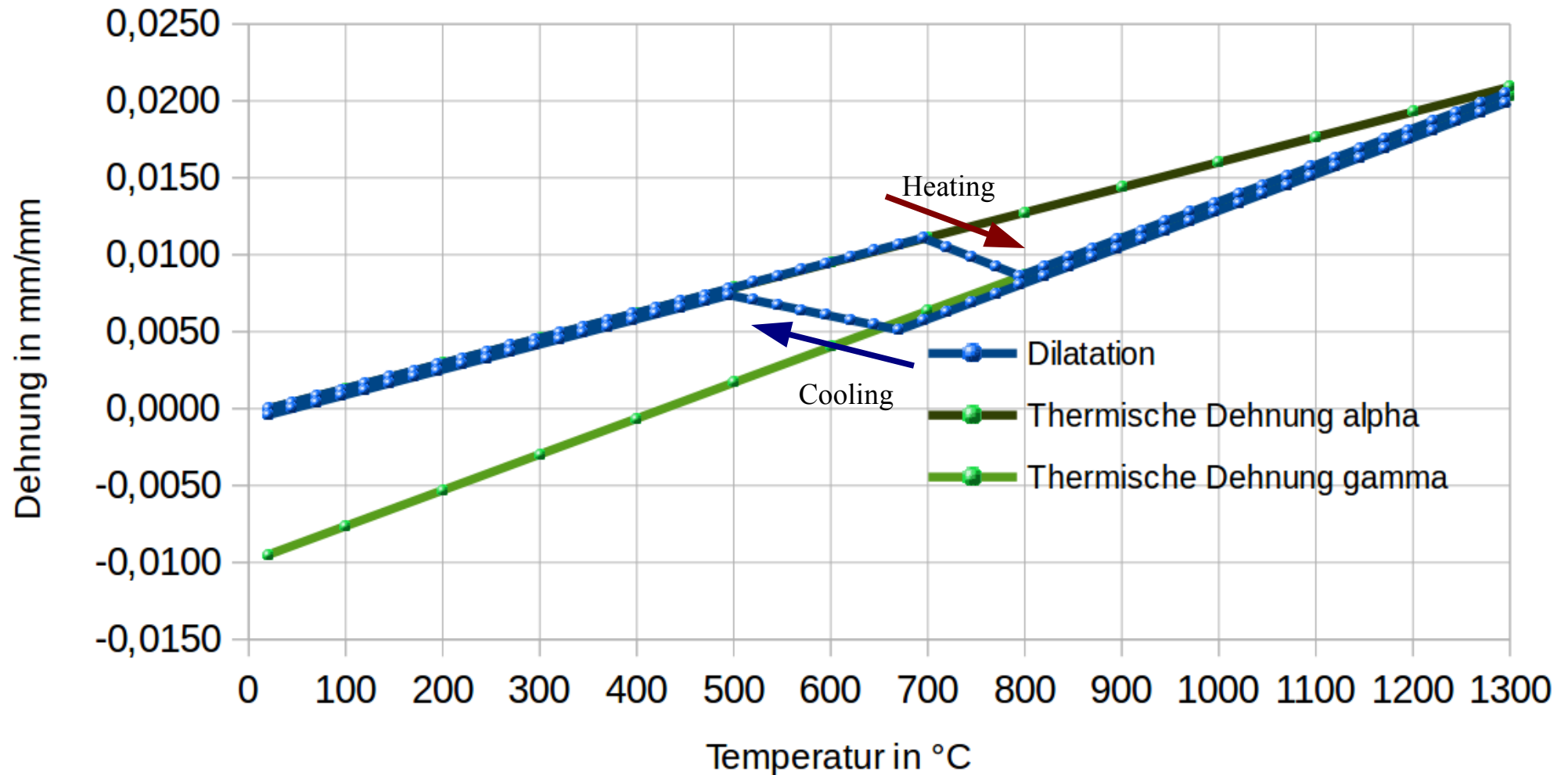

Deactivation of not yet deposited material

DynaWeld
 Time = 14.369
 Contours of History Variable#10
 min=0, at elem# 6241
 max=2328.99, at elem# 6436

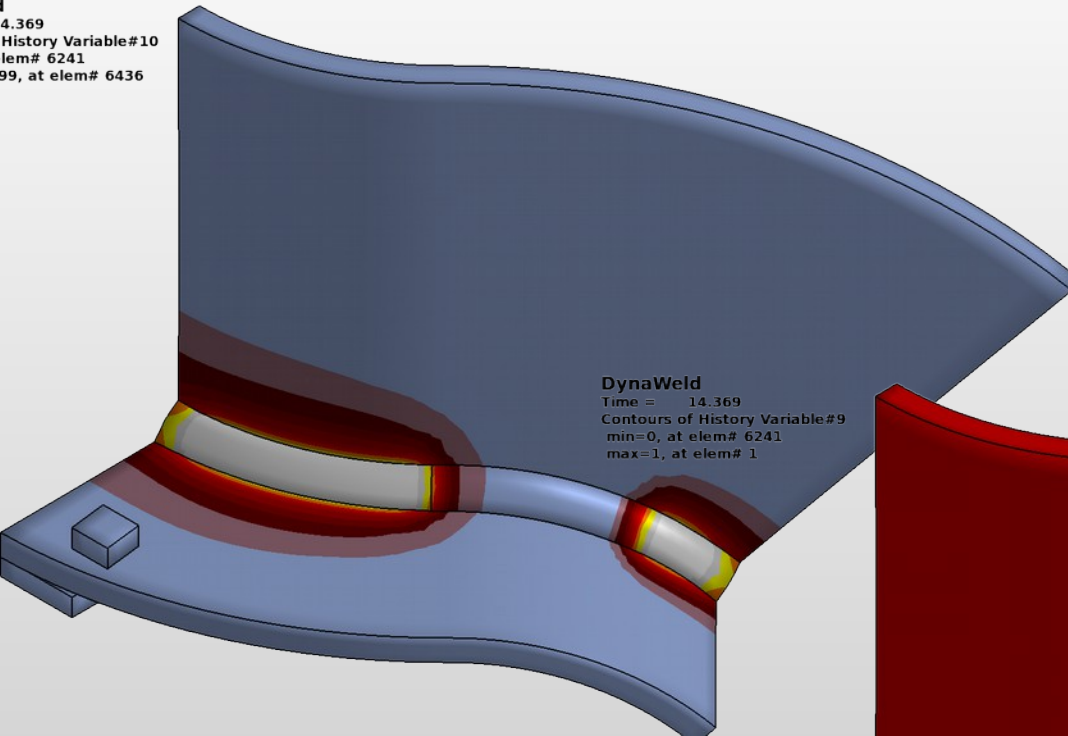

DynaWeld
 Time = 14.369
 Contours of History Variable#9
 min=0, at elem# 6241
 max=1, at elem# 1

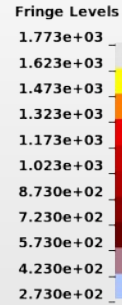

Deactivated material (blue)
 Aktivationskriterium:
 Temperatur

Peak Temperature

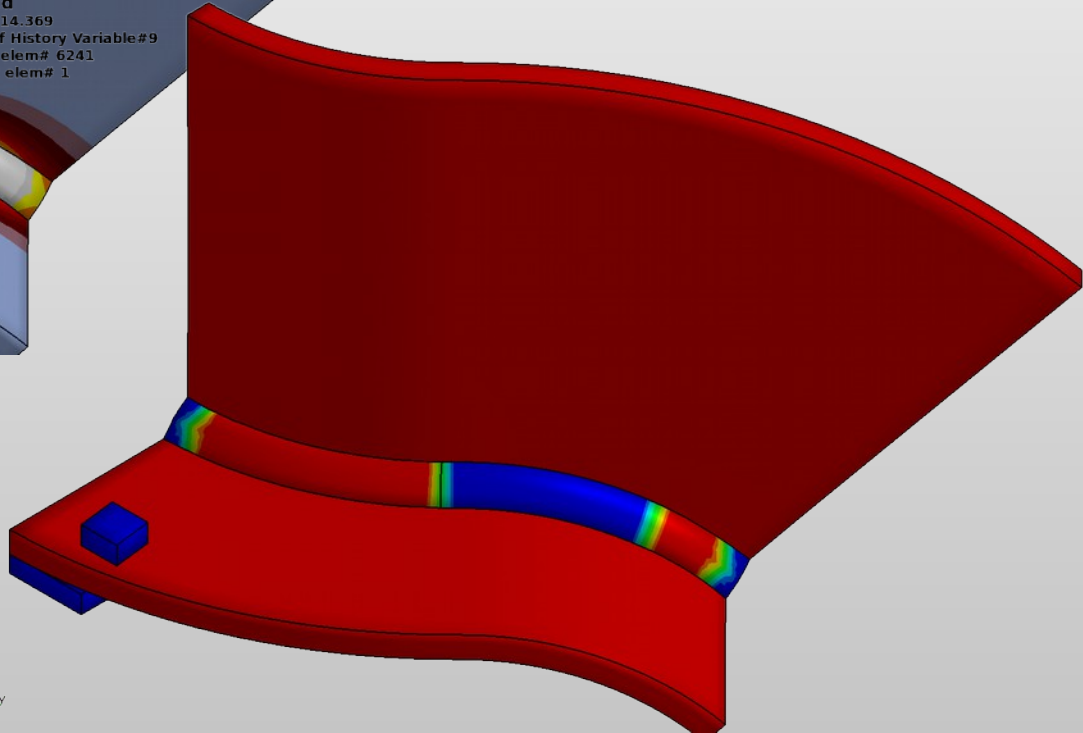
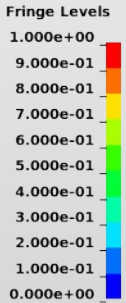

Reset of plastic strain

DynaWeld
 Time = 14.369
 Contours of Temperature
 min=293.149, at node# 8853
 max=2416.92, at node# 9719

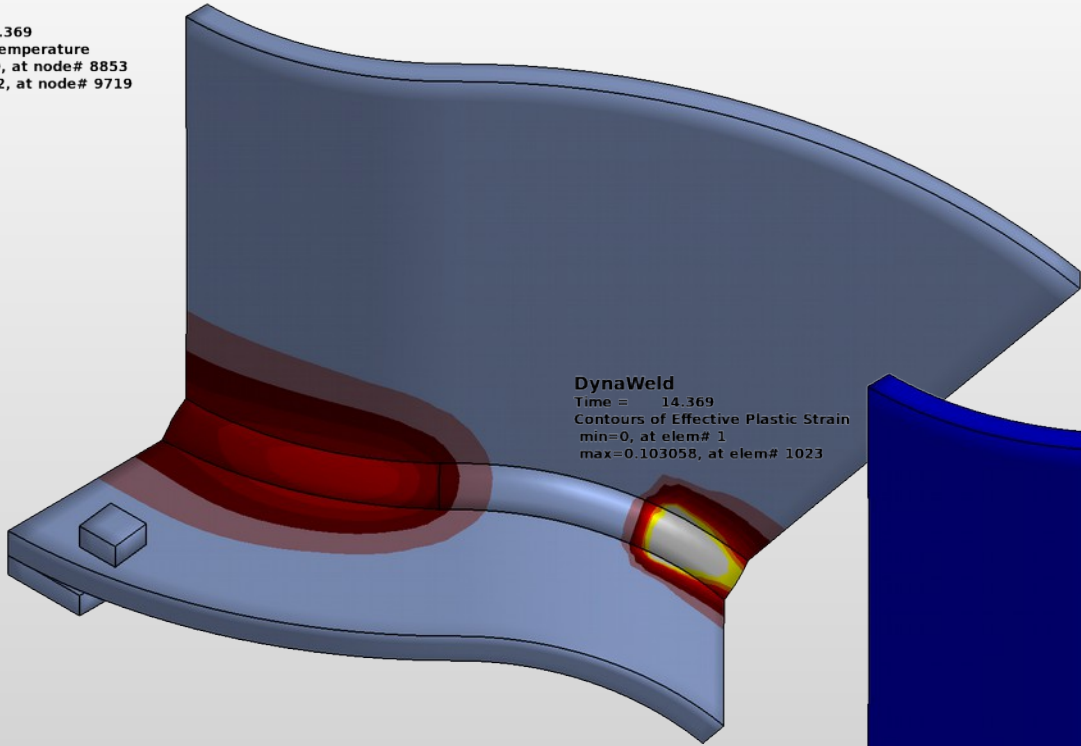

Temperature

DynaWeld
 Time = 14.369
 Contours of Effective Plastic Strain
 min=0, at elem# 1
 max=0.103058, at elem# 1023

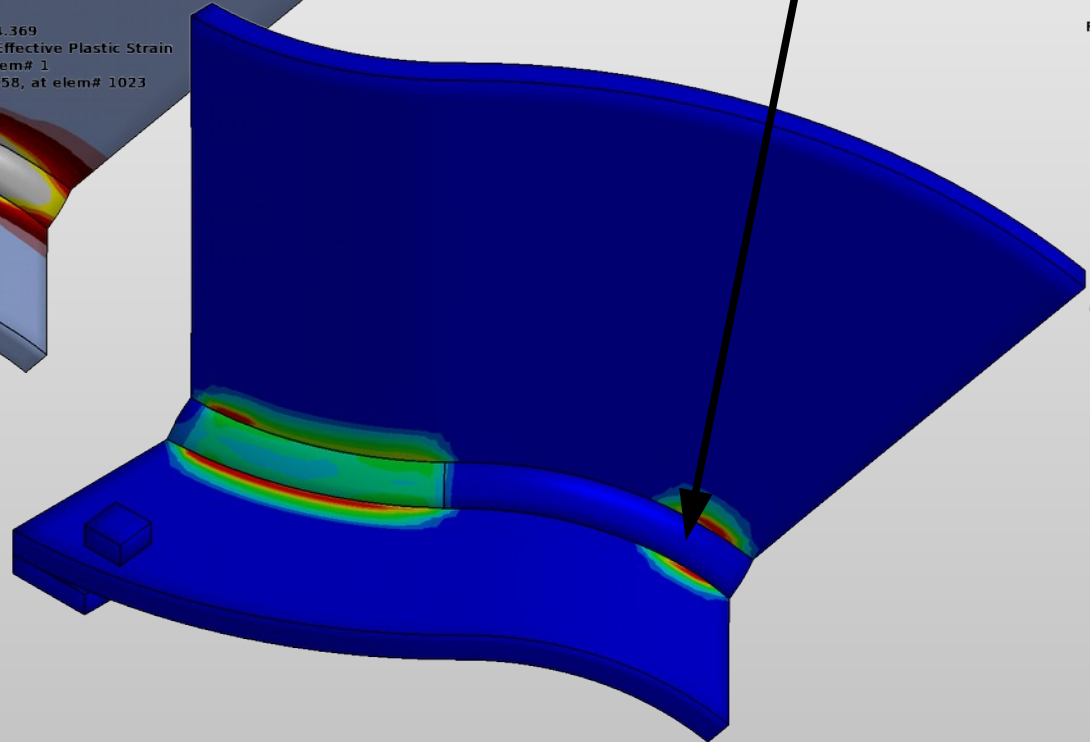

Fringe Levels
 1.773e+03
 1.623e+03
 1.473e+03
 1.323e+03
 1.173e+03
 1.023e+03
 8.730e+02
 7.230e+02
 5.730e+02
 4.230e+02
 2.730e+02

Equivalent plastic strain

Above „Annealing“-Temperature
 the equivalent plastic strain
 is kept zero

Fringe Levels
 5.000e-02
 4.500e-02
 4.000e-02
 3.500e-02
 3.000e-02
 2.500e-02
 2.000e-02
 1.500e-02
 1.000e-02
 5.000e-03
 0.000e+00

Heat Input

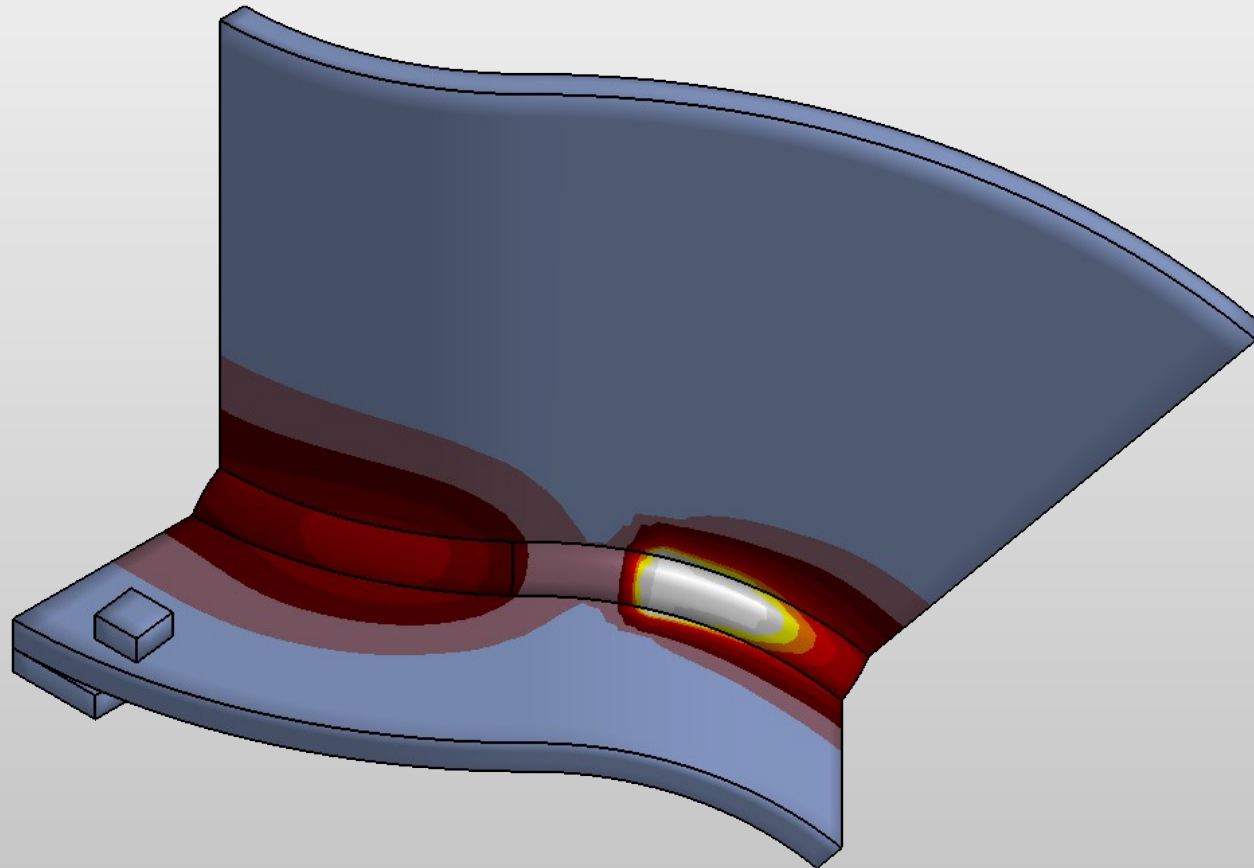

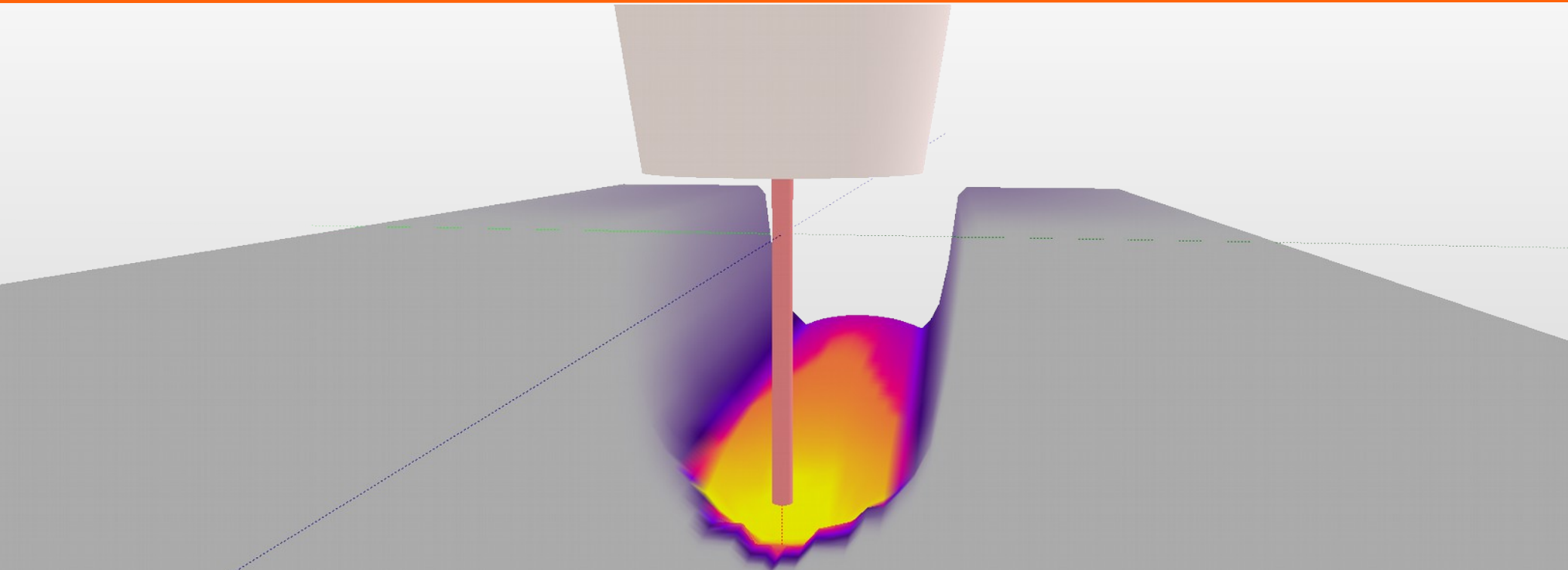

Simulation with SimWeld

Process Simulation GMAW

Numerical Prediction of Equivalent Heat Source

SimWeld Preprocessing

- Definition of:
 - weld preparation
 - geometry and geometric parameter
 - work position
 - material

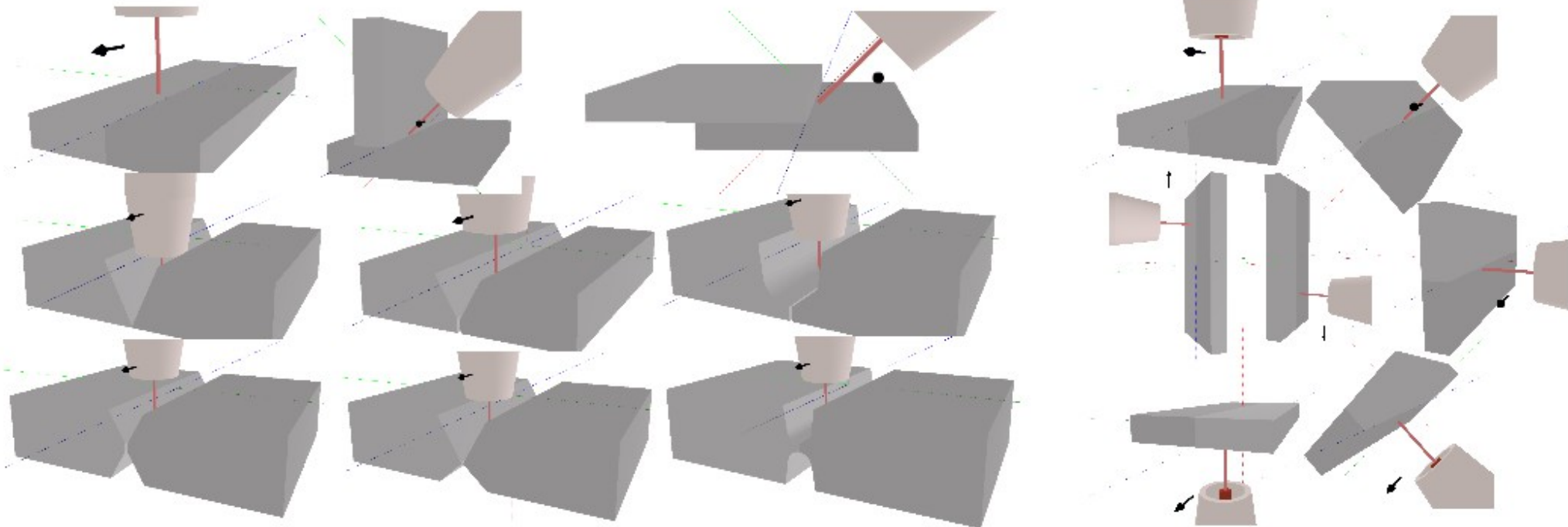

SimWeld Preprocessing

- Definition of:
 - wire: feed, diameter, material,
 - stick out
 - travel speed
 - angle of torch, stabbing, slabbing, skew
 - shielding gas
 - machine settings U, I
 - process type normal, pulsed U/I, pulsed I/I
 - pulse parameter

Wire	Equipment	Power source	
Diameter: 1.0 [mm]	Shielding gas: 82% Ar 18% CO2	Select...: Custom	
Material: SG-Fe	Welding cable	Process type: Pulsed I/I	
Contact noz. t.: 20 [°C]	<input checked="" type="checkbox"/> Consider welding cables	Wire feed: 4,6 [m/min]	
Position	Hose assembly	Pulse Shape: Steep	
X: 0,00 [mm]	Length: 3,5 [m]	Frequency: 82 [Hz]	
Y: 0,00 [mm]	Cross section: 33 [mm²]	Pulse time: 2,4 [ms]	
L: 20,00 [mm]	Cable to wire feeder	Base current: 40,0 [A]	
R: 20,00 [mm]	Length: 10,5 [m]	Pulse current: 400,0 [A]	
Angle	Cross section: 95 [mm²]	Arc length: 22,0 [%]	
Along: 0 [°]	Cable to workpiece		
Across: 0 [°]	Length: 10,5 [m]		
	Cross section: 95 [mm²]		
	Voltage metering		<input type="button" value="SIMULATION 3.1"/> <input type="button" value="Pause"/> <input type="button" value="Stop"/>
	<input checked="" type="checkbox"/> Execute voltage metering		

SimWeld Results

- Equivalent Heat Source
- Weld Pool Geometry
- Droplet
- Wire Temperature
- Energy, Voltage, Currency
- Temperature Curve

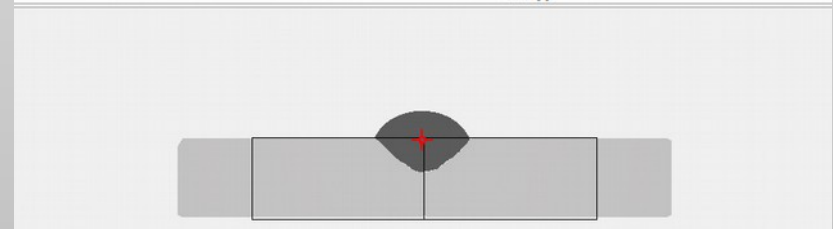
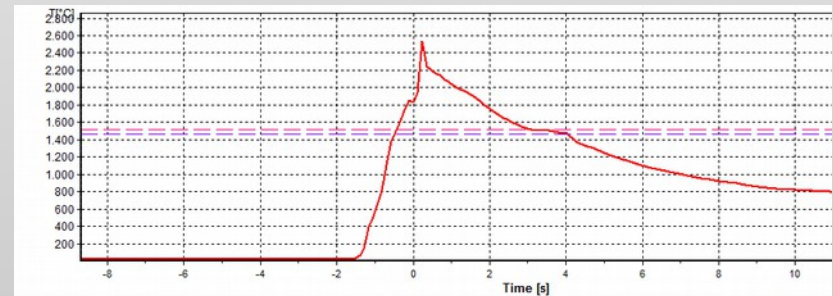
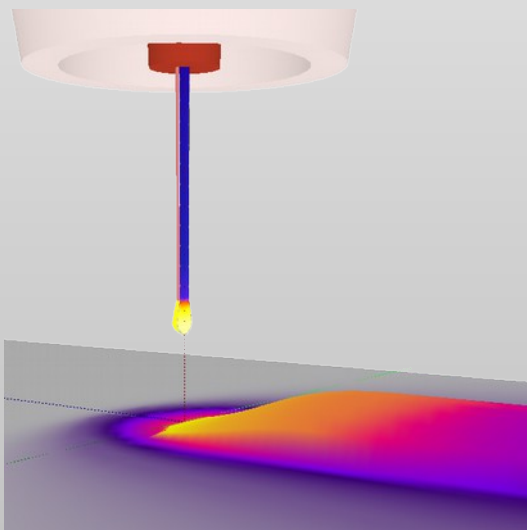
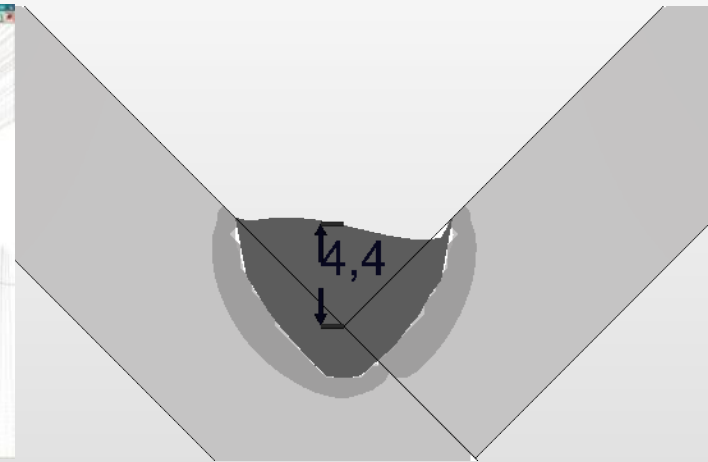
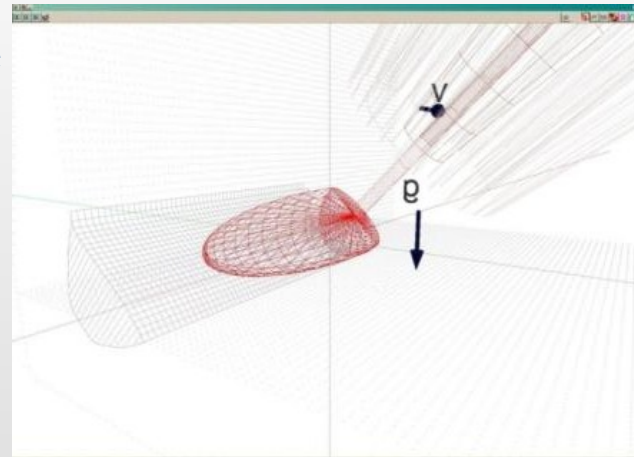

Estimation of Heat Source Parameter from Welding Procedure Specification (WPS) for Arc Weld, TIG, GMAW, SAW

- Velocity
- Estimation of weld pool geometry
 - length = length of heat source
 - depth = depth of heat source
 - width = width of heat source
- Energy input per time
 - Voltage
 - Current
 - Energy per unit length
- Estimation of efficiency
 - TIG: 0,75
 - GMAW: 0,8
 - SAW: 1,0

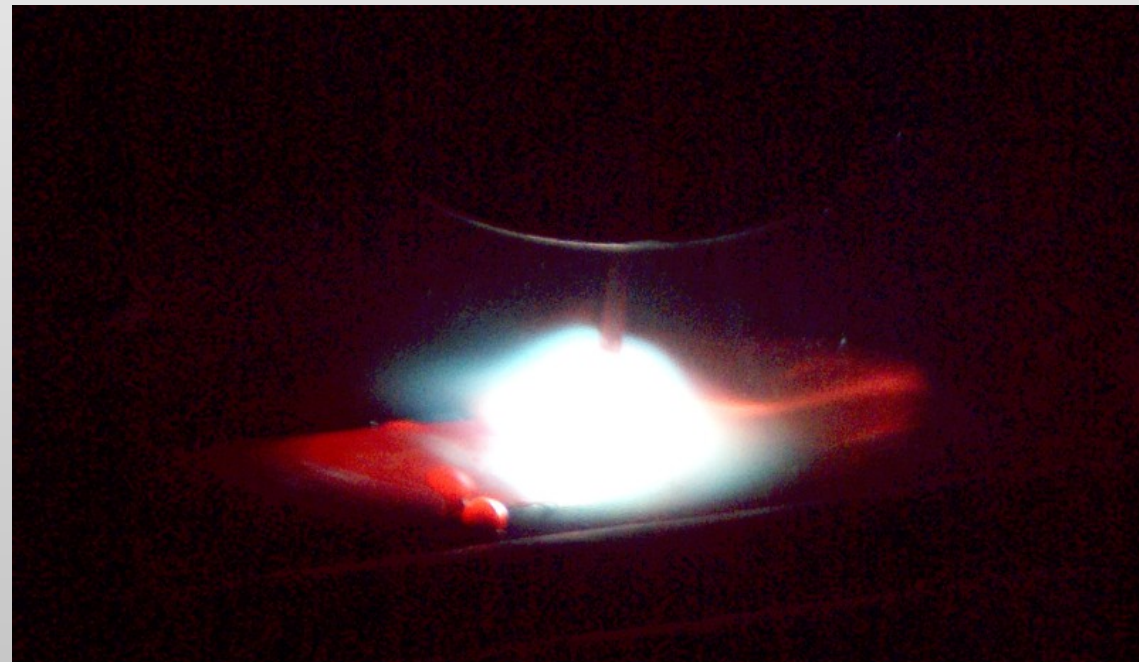

Doppelt-Elipsoide Heat Source (Loose)

with constant heat source density

Heat Source Code	DynaWeld
LE	Solid
LEP	Solid Part
TRLE	Solid trajectory reference
TSLE	Solid trajectory surface
SLE	Shell
SLEP	Shell Part
SHLE	Shell Surface
SHLEP	Shell Surface Part

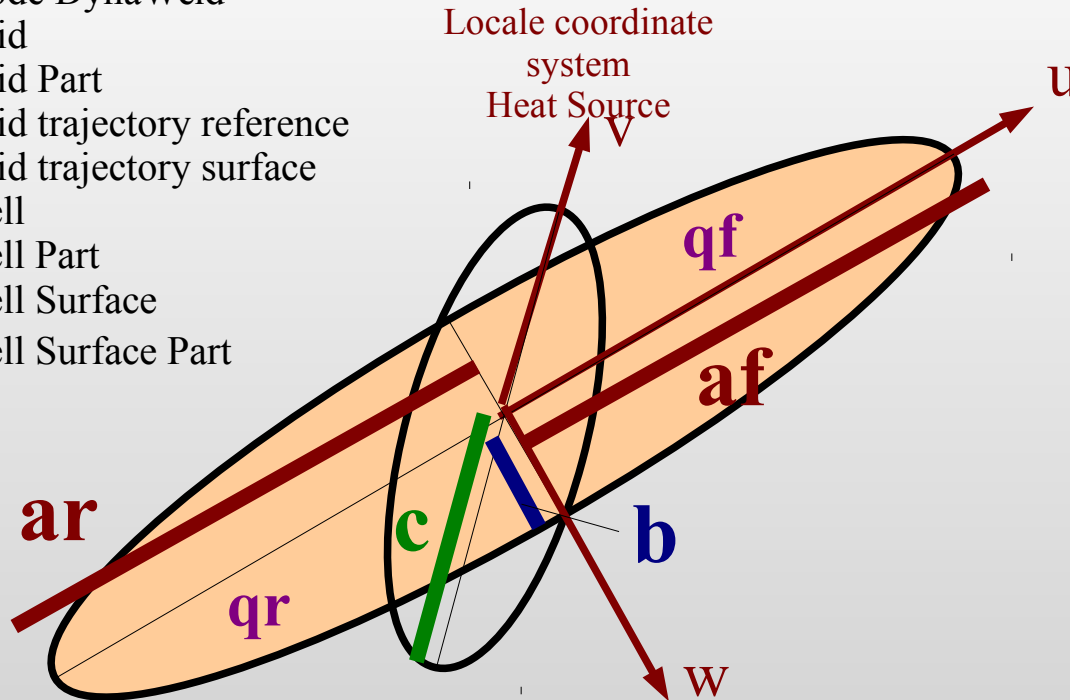

Geometry function (double-ellipsoid)

Parameter:

- Q: total energy per unit time
- q_f: source density front
- q_r: source density rear
- ff: ratio front
- fr: ratio rear
- a_f: radius front
- a_r: radius rear
- b: radius width
- c: radius depth

q_f, q_r: Wärmequellldichte konstant:

- Wärmeeintrag q_f für $(u/a_f)^2 + (v/c)^2 + (w/b)^2 \leq 1$
- Wärmeeintrag q_r für $(u/a_r)^2 + (v/c)^2 + (w/b)^2 \leq 1$

$$q_f = 1,5 * Q * ff / (a_f^2 * b^2 * c^2)$$

$$q_r = 1,5 * Q * fr / (a_r^2 * b^2 * c^2)$$

$$ff + fr := 2$$

Laser, Electron Beam, Laser-Hybrid Adjustment due to Microsection

- Velocity
- Estimation of the geometry of weld pool from microsection
- Geometry of weld pool = geometry of equivalent heat source
- Adjustment of heat input until calculated liquidus line fits liquidus line of microsection

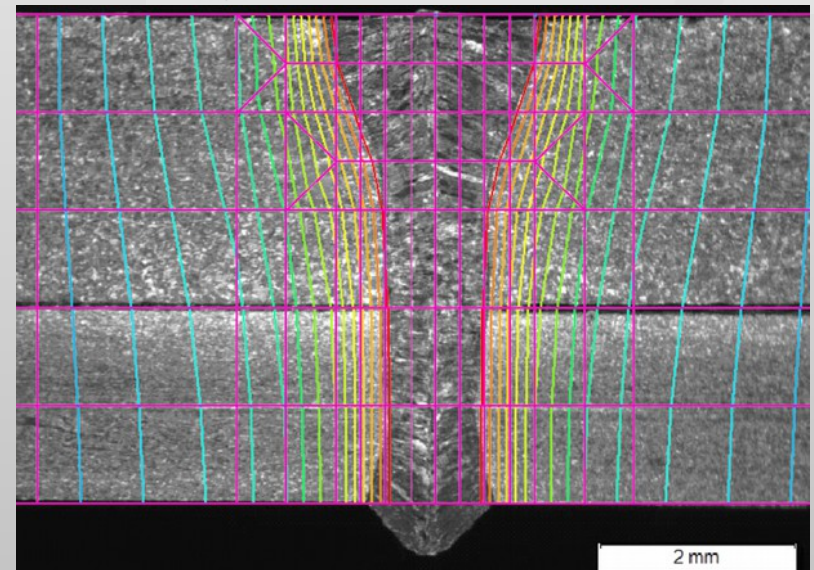
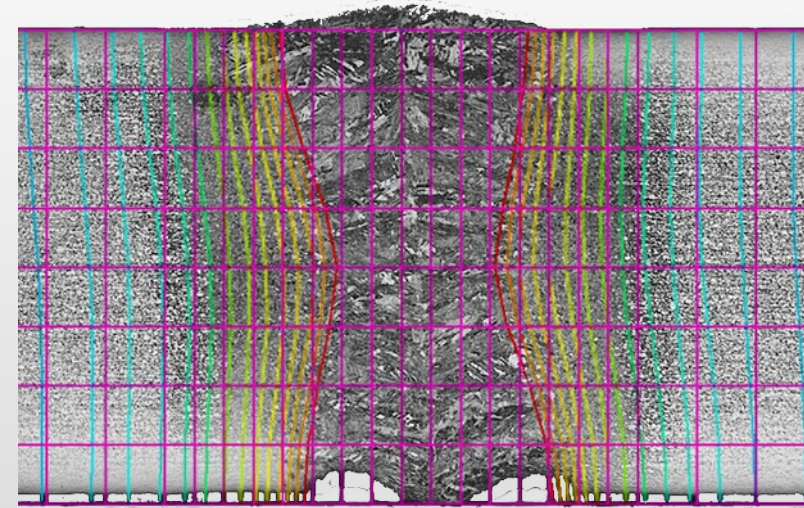

Double Conical Heat Source (Loose)

with constant heat source density

Heat Source Code	DynaWeld
TRLK	Solid
LK	Solid
LKP	Solid Part

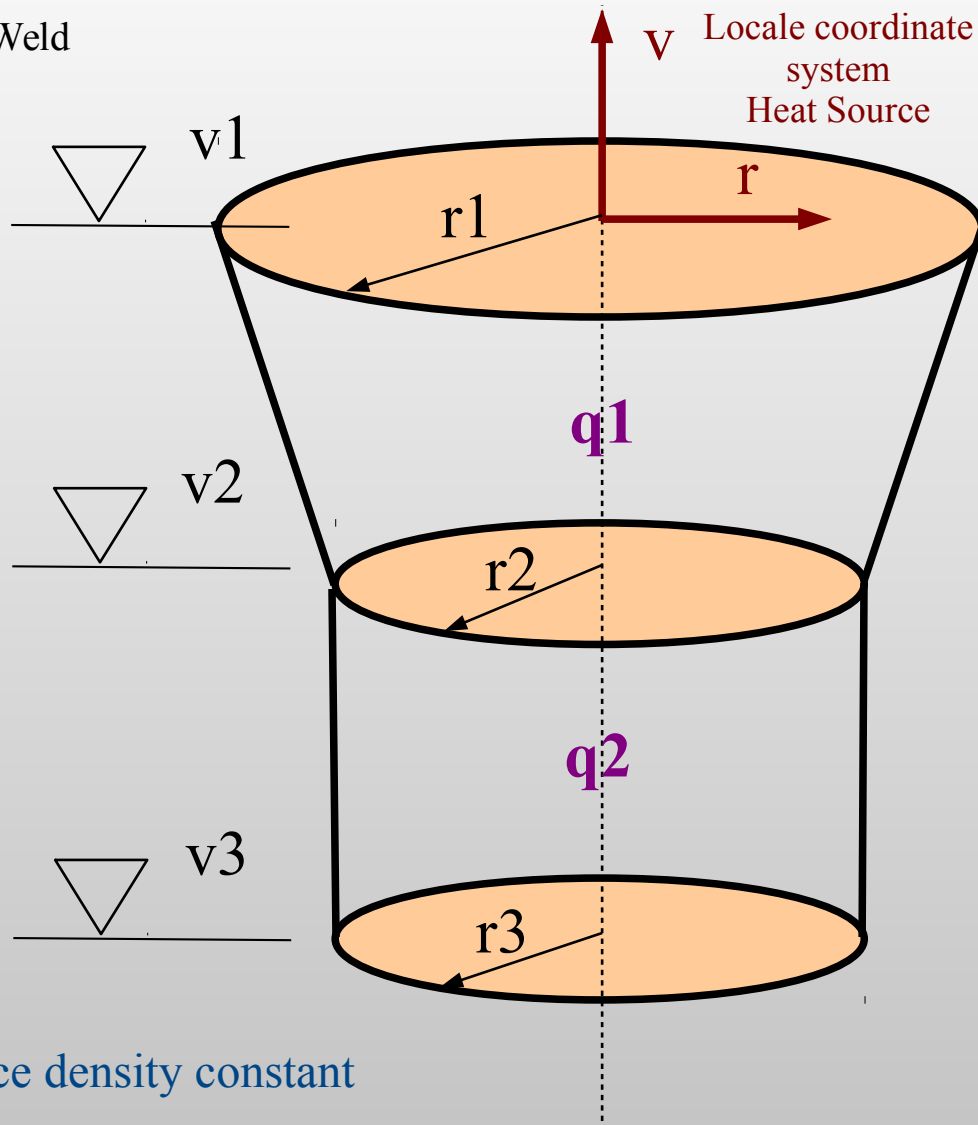

Geometry function (double-ellipsoid)

Parameter:

- q1: source density top
- q2: source density bottom
- r1: radius top
- r2: radius middle
- r3: radius bottom
- v1: v-coordinate top
- v2: v-coordinate middle
- v3: v-coordinate bottom

q1, q2: heat source density constant

Local Coordinate System Heat Source

Moving along Trajectory

ay:

Rotation of the reference around the trajectory.
The reference needs to be adjusted in torch or beam direction.

For the Heat Sources with the DynaWeld Code TSxx only a trajectory needs to be defined. The Reference is automatically set normal to the surface.

Global Coordinate System

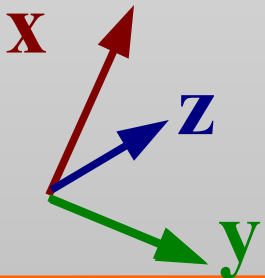

NodeSet 7mm
Reference
Trajektorie
NodeSet 4mm

v-offset:

movement of heat source in direction of torch

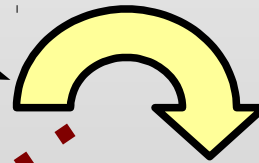

w-offset:

movement lateral to the direction of torch and lateral to the direction of travel

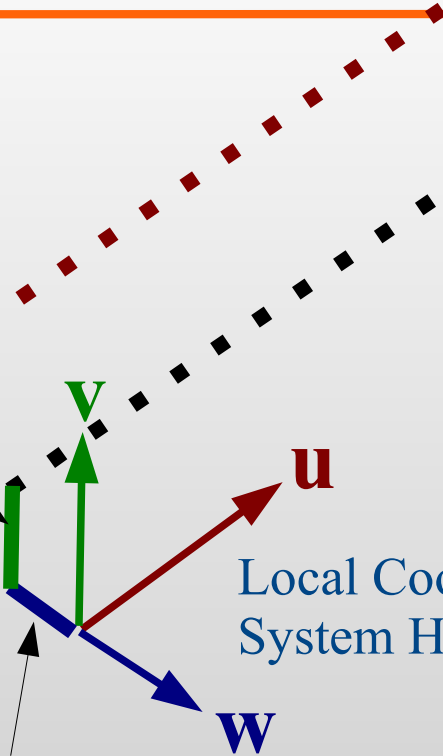

Local Coordinate System Heat Source

- u:** Trajektorie direction
- v:** Torch direction
- w:** Lateral direction

Final Adjustment of Heat Input

Determination of calibration factor k_f to achieve the target heat input

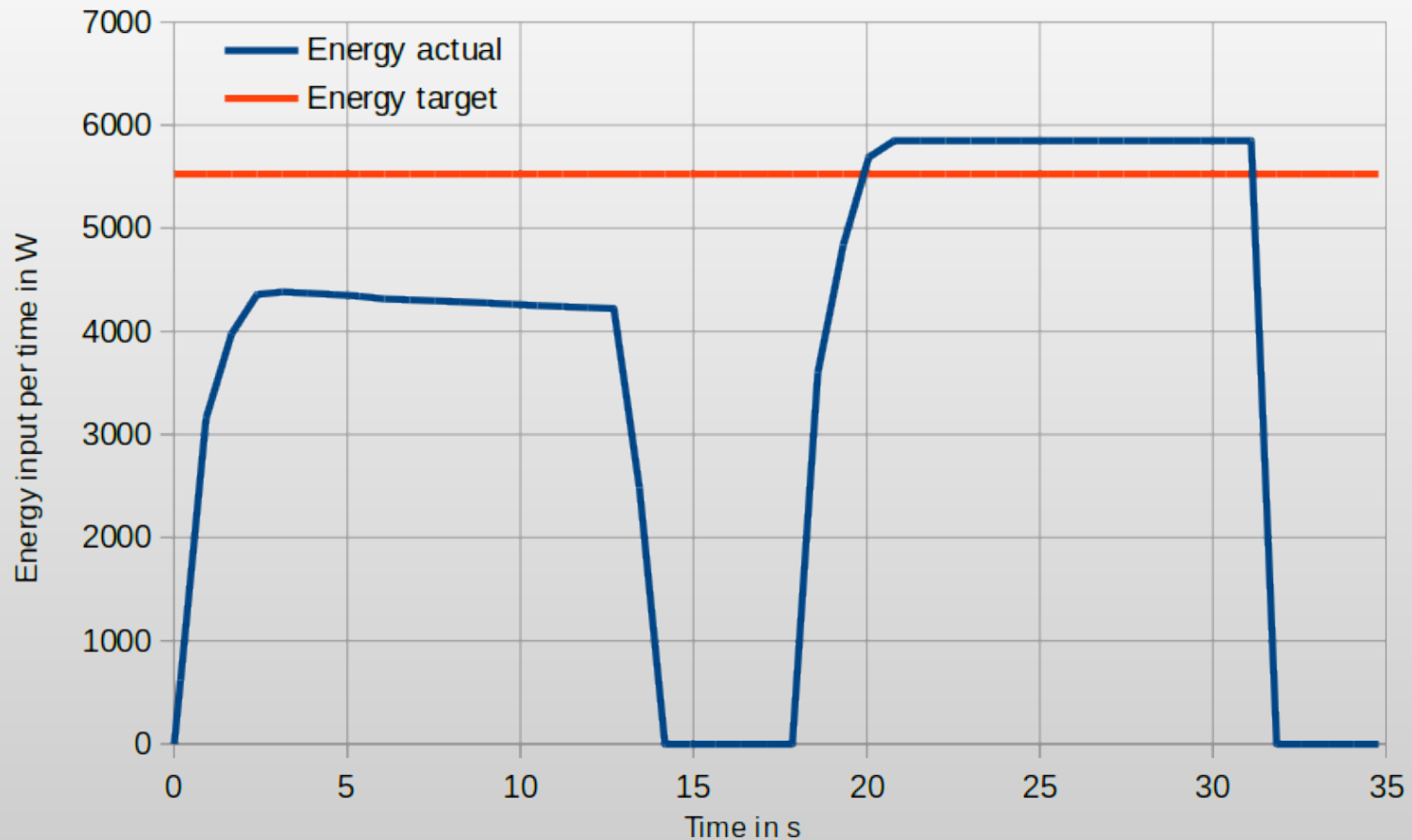

Heat Input Adjustment:					
Weld	actual	target	Faktor	kf old	kf new
1001	4212,63	5525,82	1,31	1,00	1,31
1002	5838,02	5525,82	0,95	1,00	0,95

Metatransient Heat Source

with constant heat source density in the whole part

Heat Source code DynaWeld

PH Solid Part

PHS Shell Part

Parameter:

Q: total energy per unit time

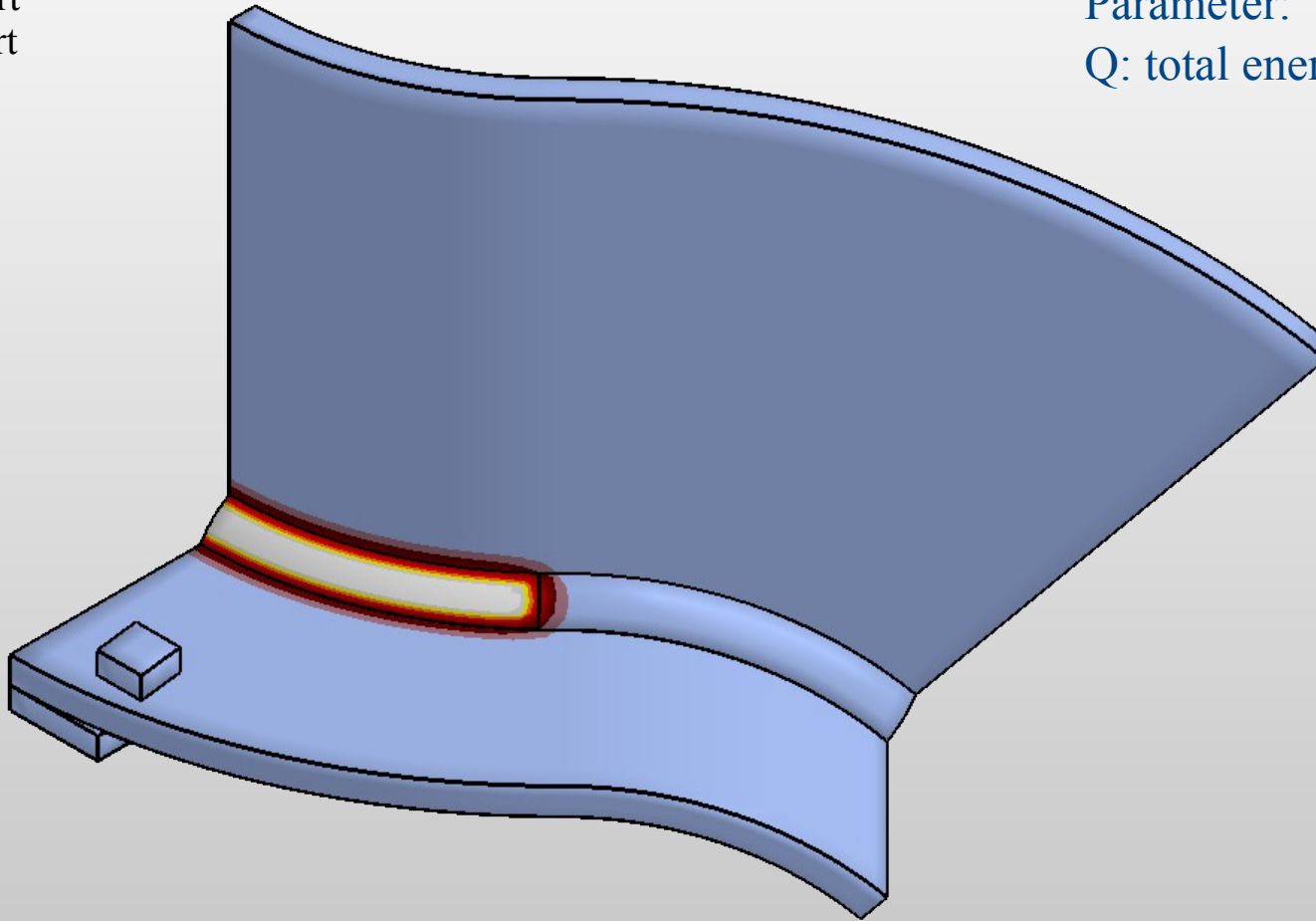

q : heat source density constant over all elements of considered part.

Metatransient Method with Energy calibration

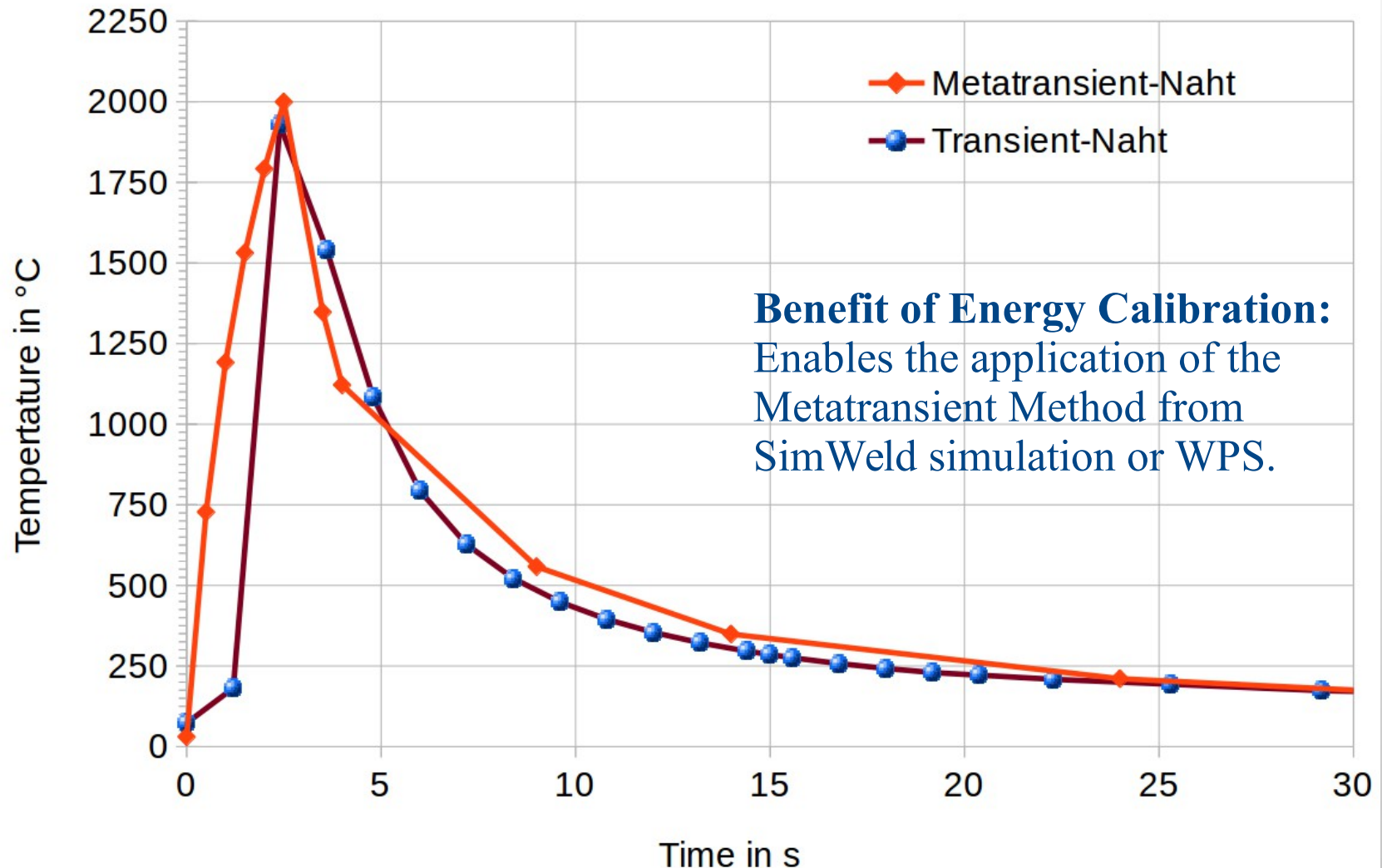

Metatransient Method with Energy calibration

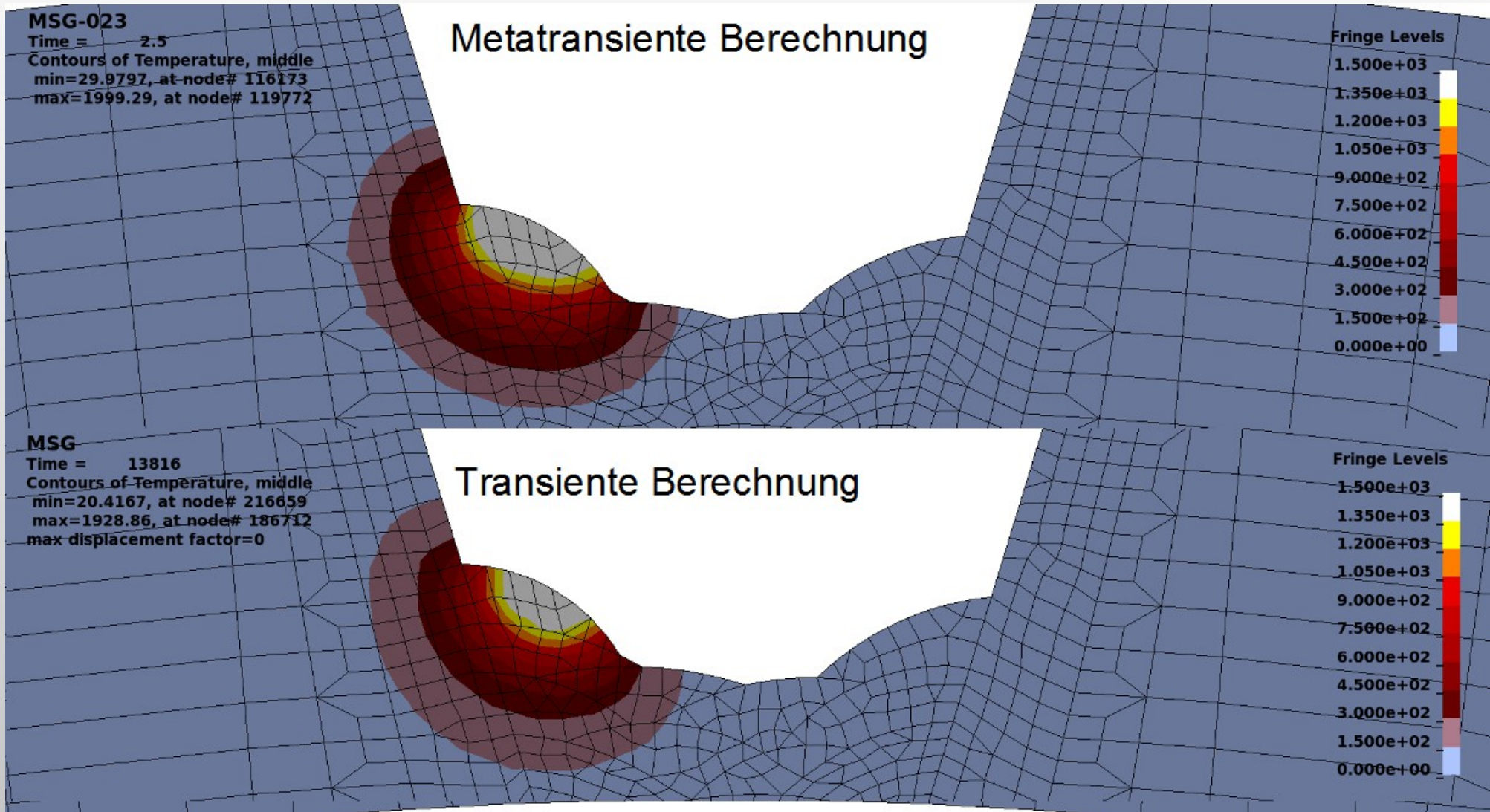

Process

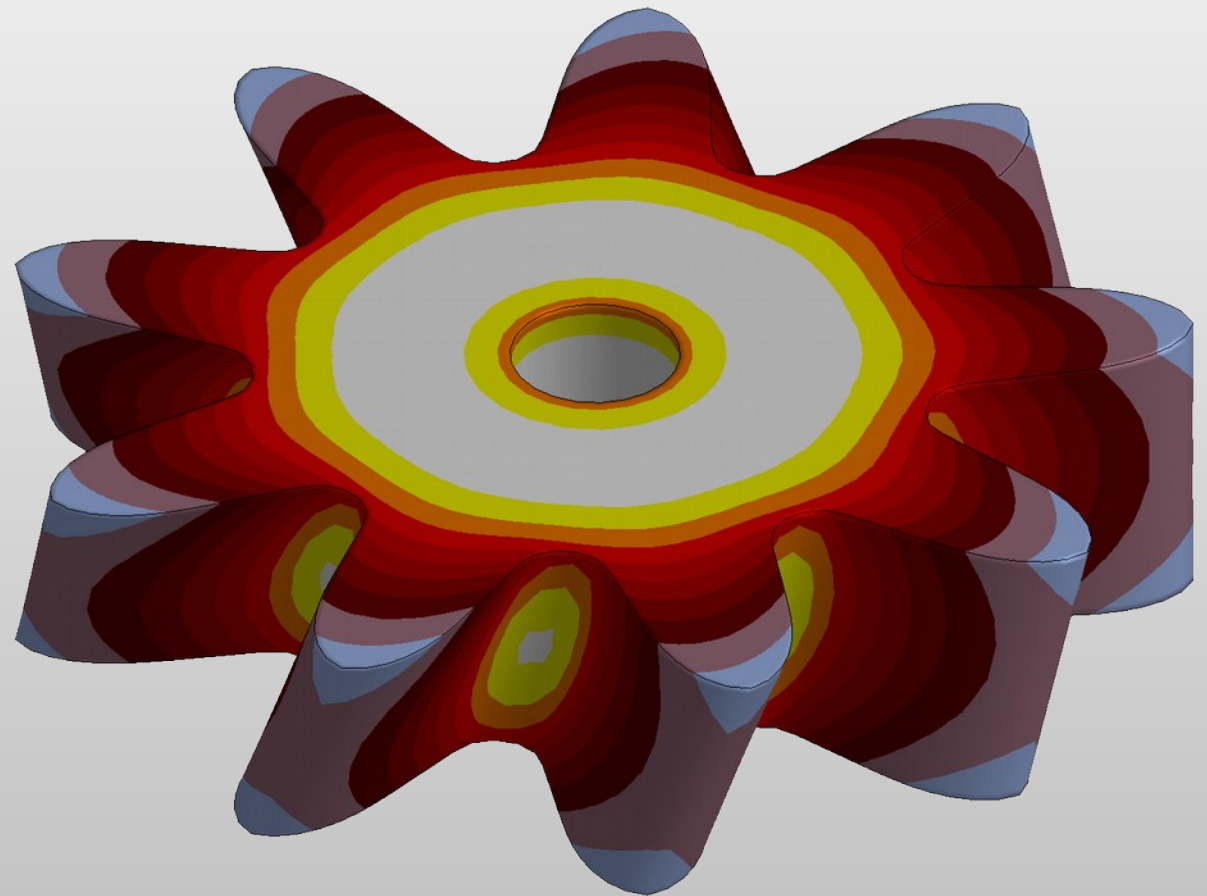

Welding

Heating

Cooling

Reheating

Tempering Effects

**Grinding and
Rewelding**

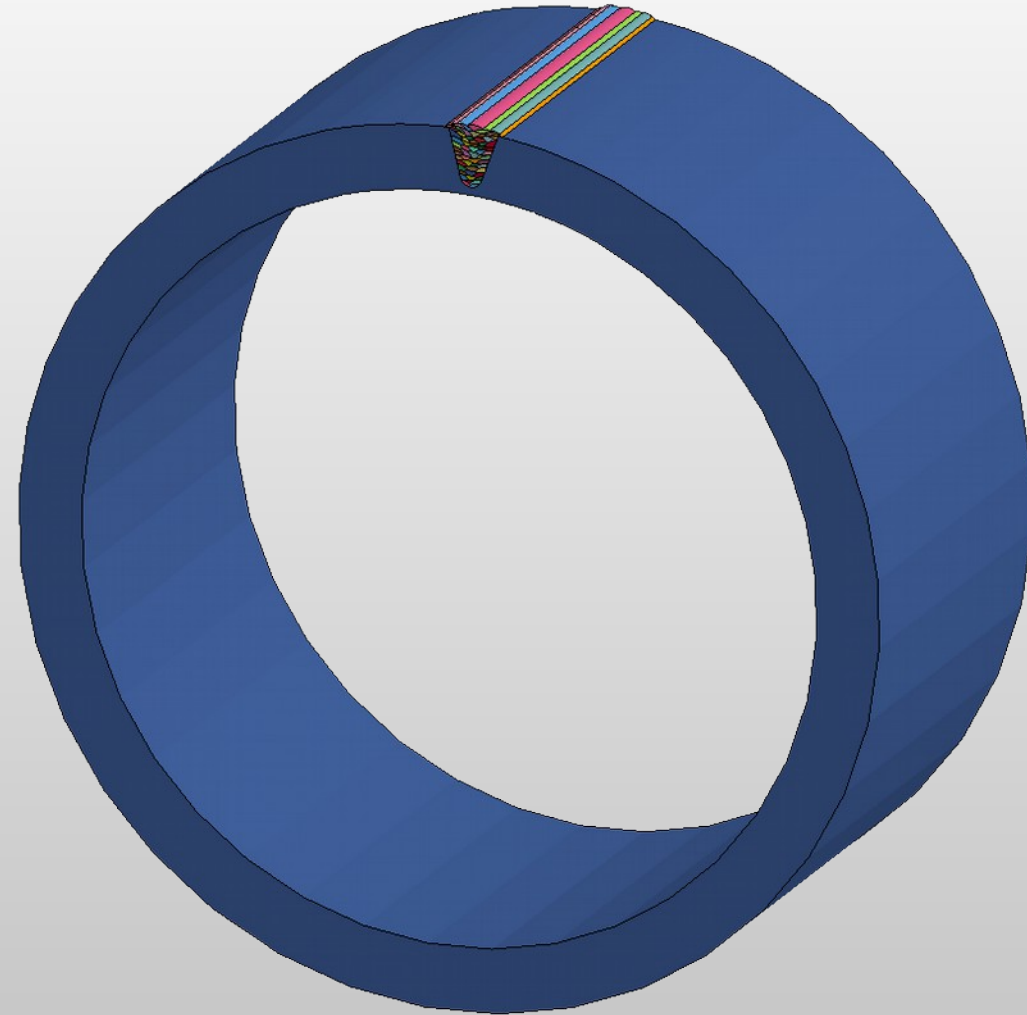

Heat Treatment

Heating

Thermal Heating
Inductive Heating

Carburisation

Quenching

Tempering

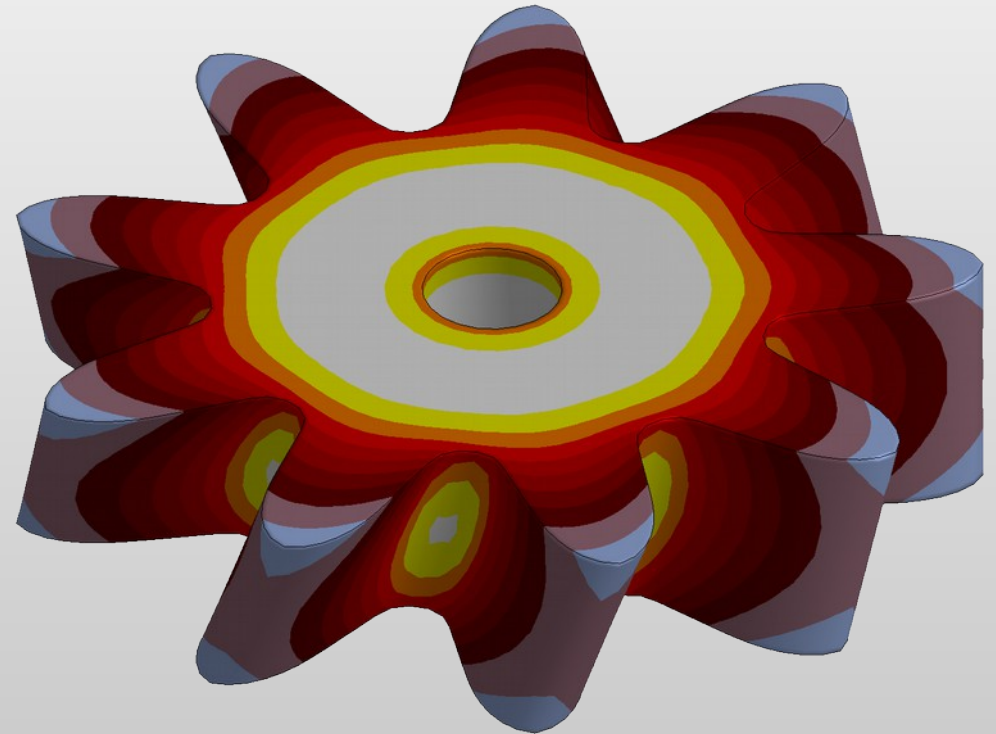

Process Chain

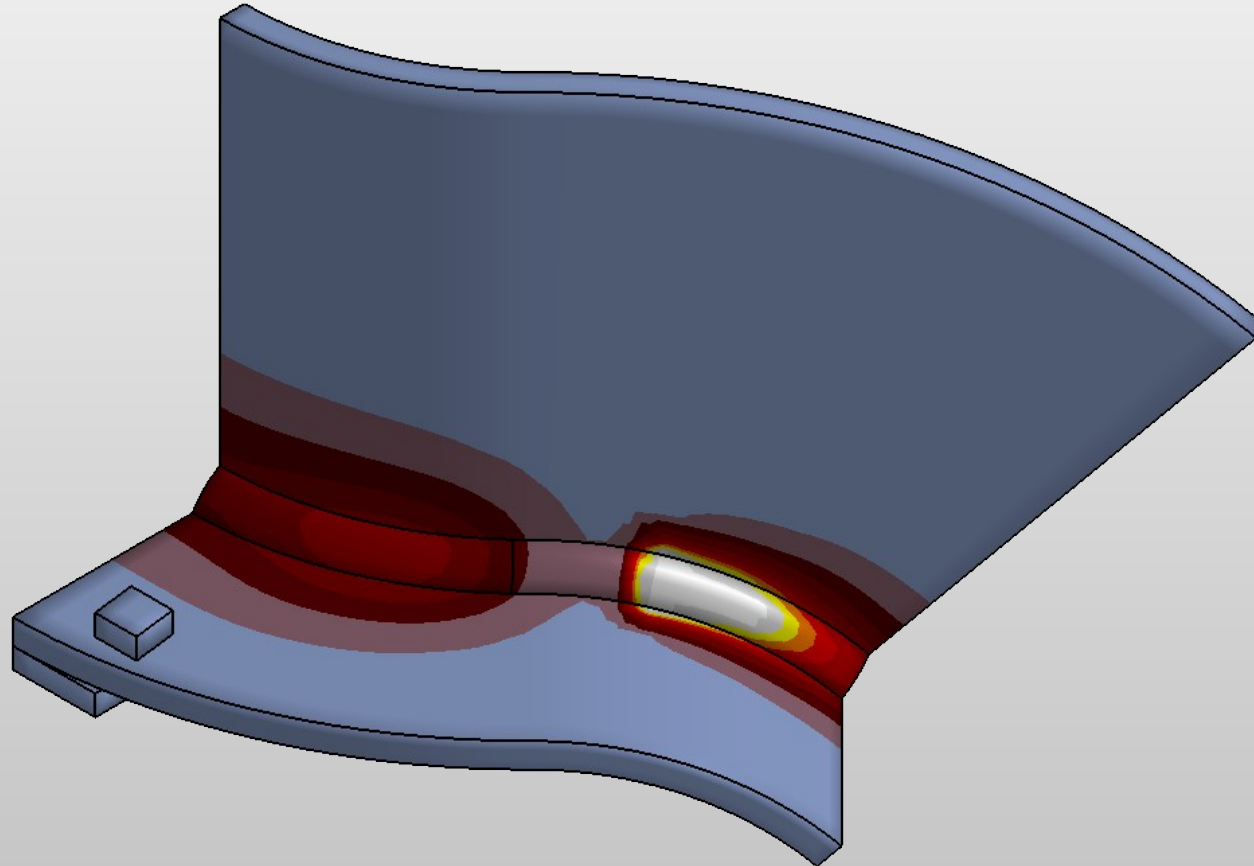

Manufacturing of a Box

Task and Model

Forming:

- The roof geometry is made by forming a 3 mm thick sheet (1.4301)

Assembly:

- Add the sidewall

Welding:

- Weld the sidewall to the roof

Clamp and predeformation:

- press the sidewall on measure

Assembly:

- Add the bottom plate

Welding:

- Weld the bottom plate to the sidewall

Unclamping

Model:

- Solid-element model
- Material model (*MAT_270) is used in all steps
- History variables and deformations are kept from one step to an other
- Implicit analysis in all steps

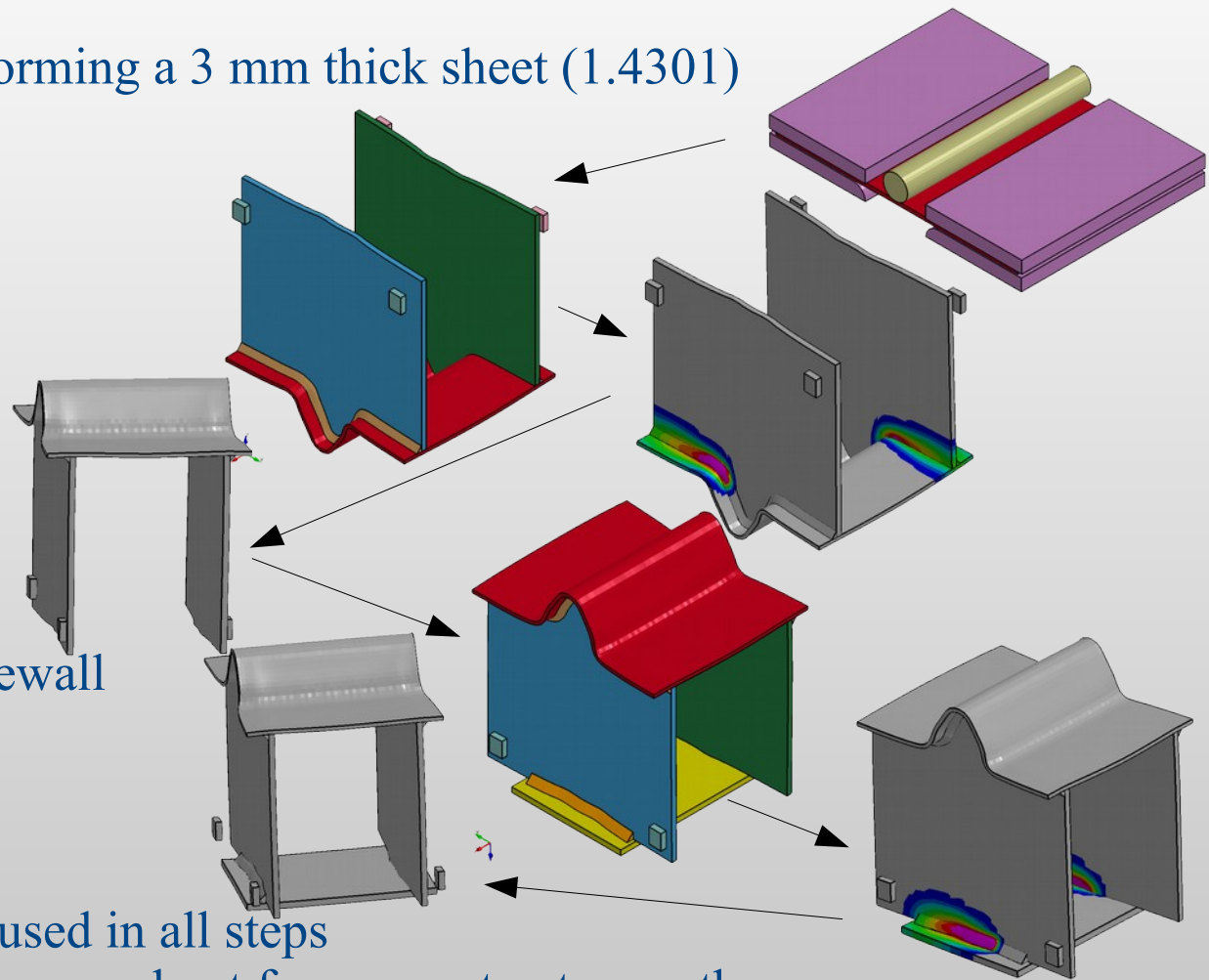

Deep-Drawing of a Cup from a Laser Welded Sheet

Task and Model

Welding:

- Two sheets (S355) with 1 mm wall thickness are laser welded

Forming:

- The welded and distorted sheet is clamped
- a globular die is pressed slow in the sheet.

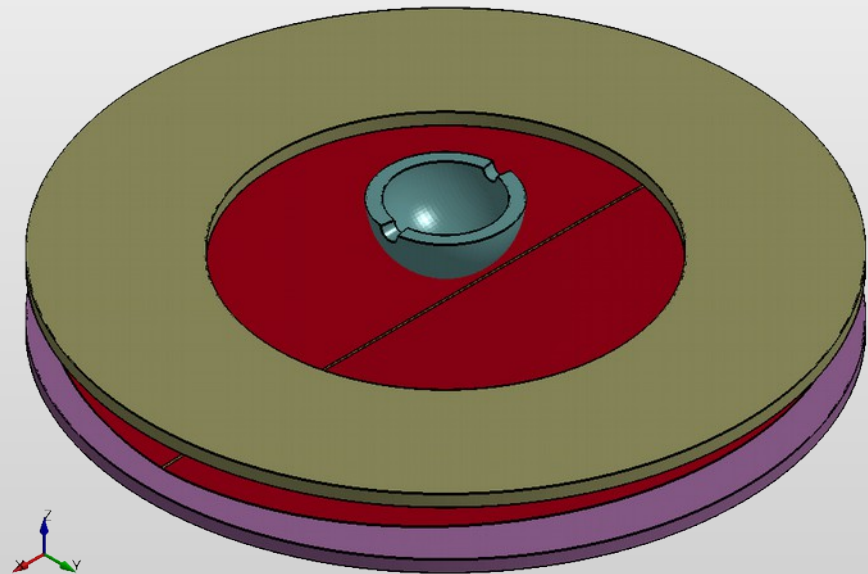

Model:

- Shell-elements are used for the sheet, solid elements are used for the clamps and the die
- Same material model (*MAT_244) is used in all steps
- History variables, phase proportions and deformations are kept from one step to an other
- Welding: implicit analysis, Forming: explicit analysis

Stresses and Strains in Midsurface of Shell after welding and deep drawing

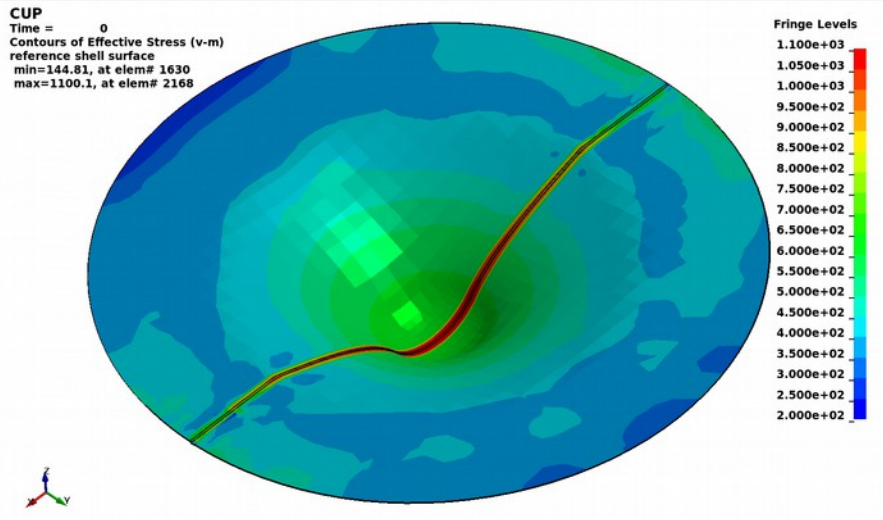

top left:

effectiv stress bevor unclamping
200 .. 1100 N/mm²

bottom left:

effectiv stess after unclamping
0 .. 200 N/mm²

bottom right:

plastic strain after unclamping
0 .. 0.65 m/m

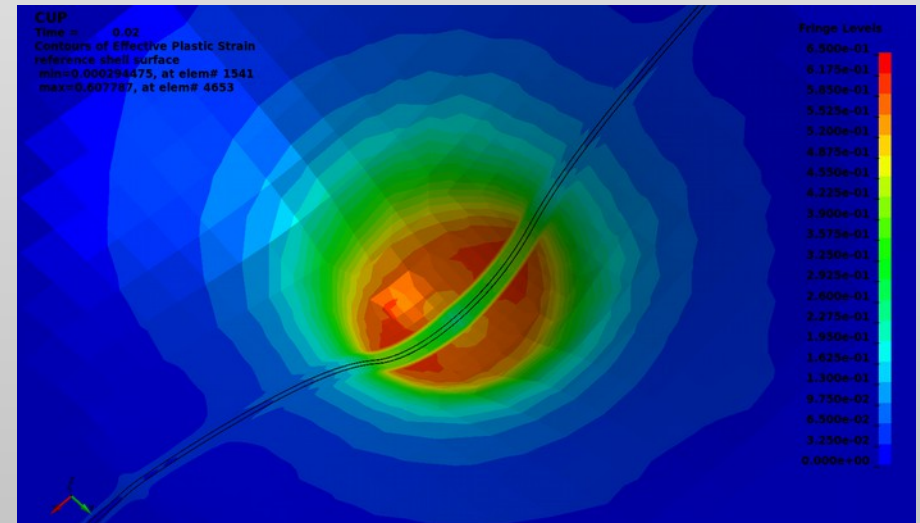
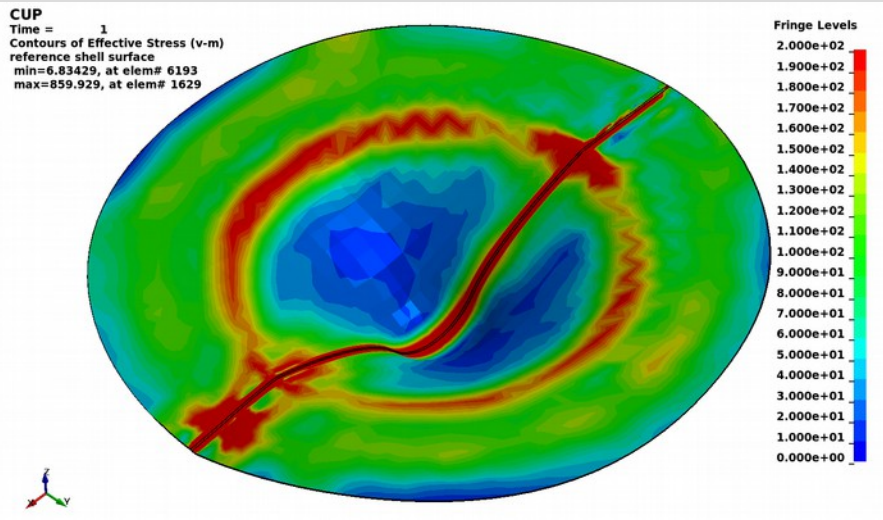

Microstructure during Deep-Drawing

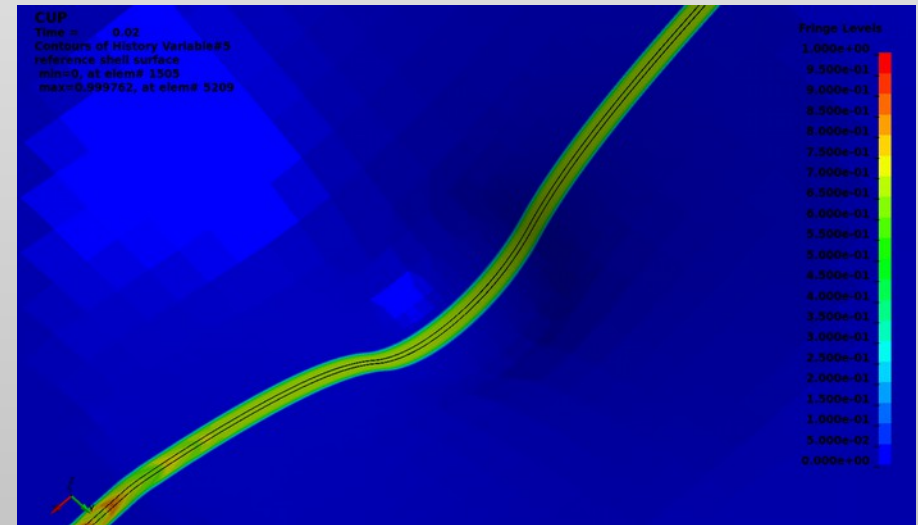
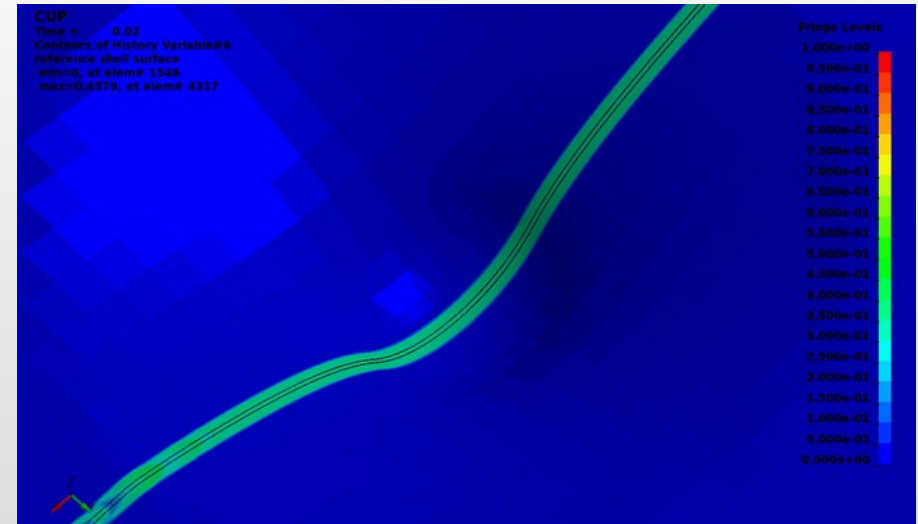
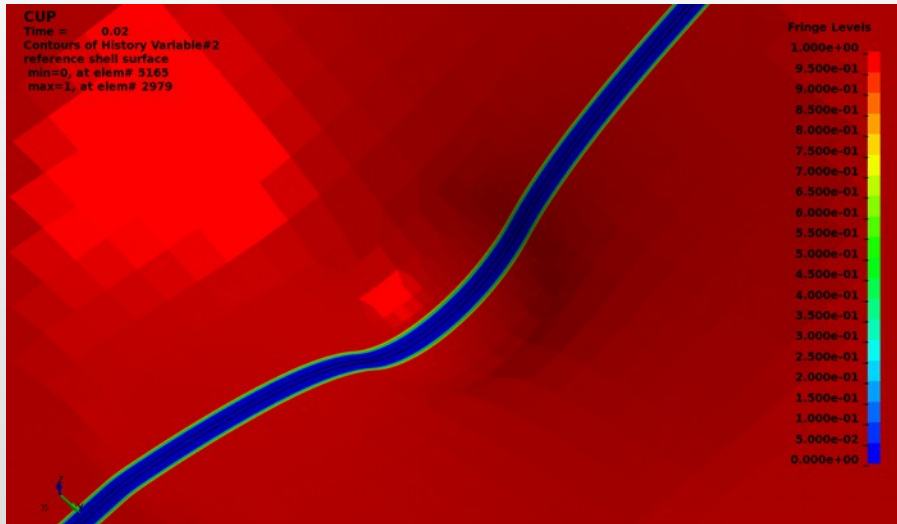

top left:
Ferrit proportion

top right:
Bainit proportion

bottom right:
Martensit proportion

Effective Stress during Forming

Influence of Material Property Change from Welding

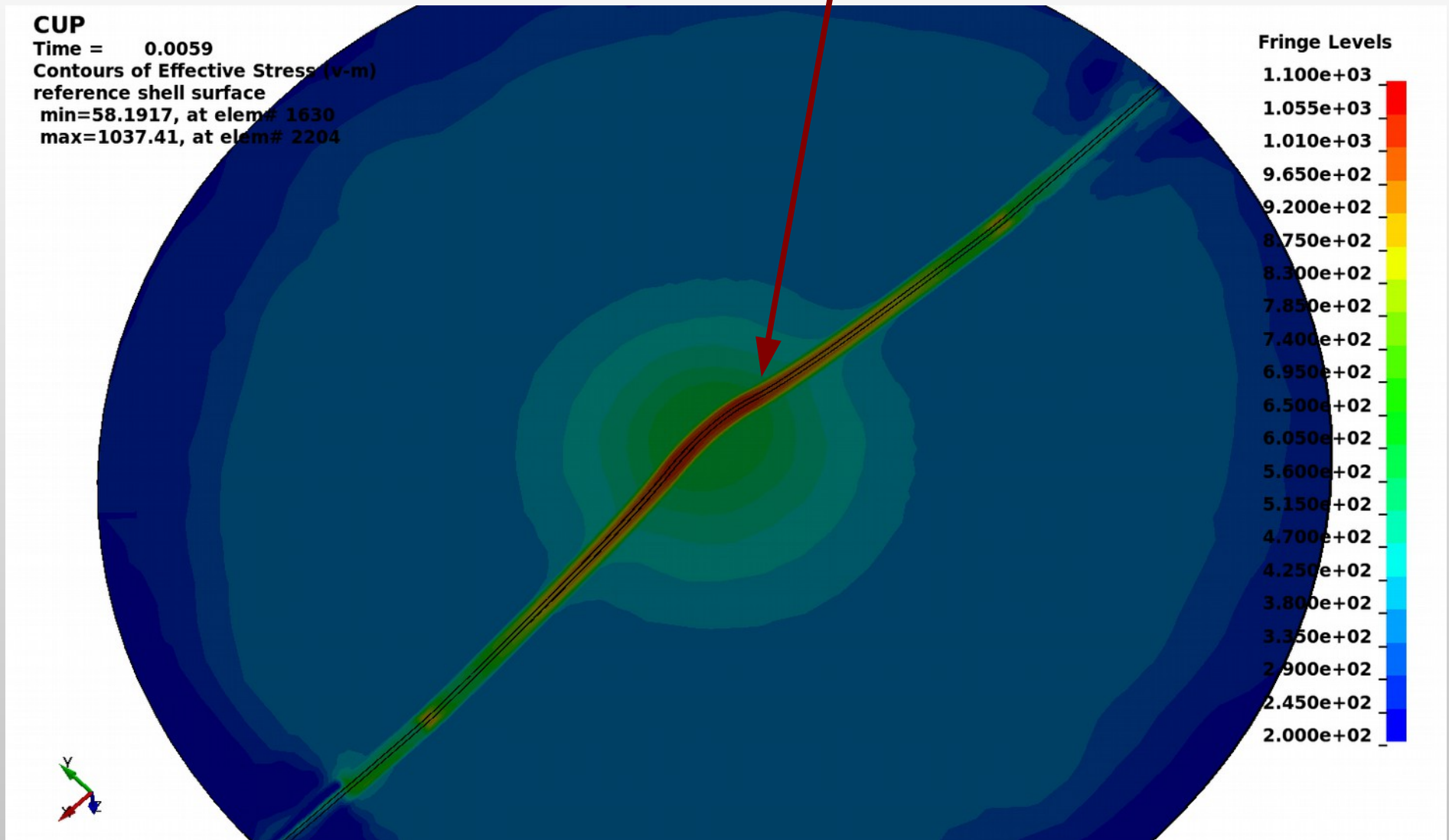

Thinning of the Sheet

Influence of Material Property Change from Welding

CUP

Time = 1

Contours of % Thickness Reduction- based on current z-strain

min=-21.1098, at elem# 1638

max=44.7195, at elem# 4653

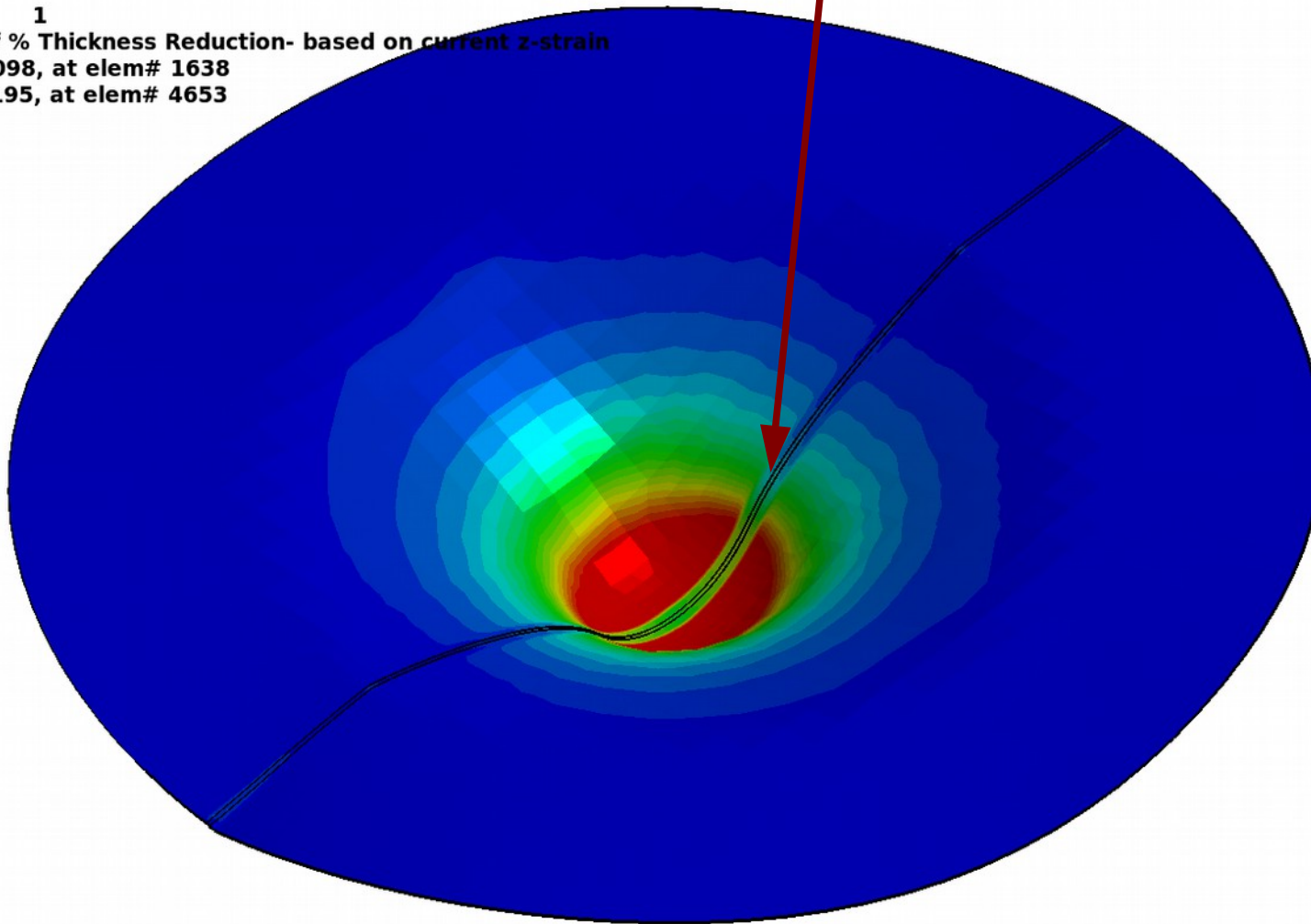

Fringe Levels

4.000e+01

3.800e+01

3.600e+01

3.400e+01

3.200e+01

3.000e+01

2.800e+01

2.600e+01

2.400e+01

2.200e+01

2.000e+01

1.800e+01

1.600e+01

1.400e+01

1.200e+01

1.000e+01

8.000e+00

6.000e+00

4.000e+00

2.000e+00

0.000e+00

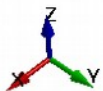

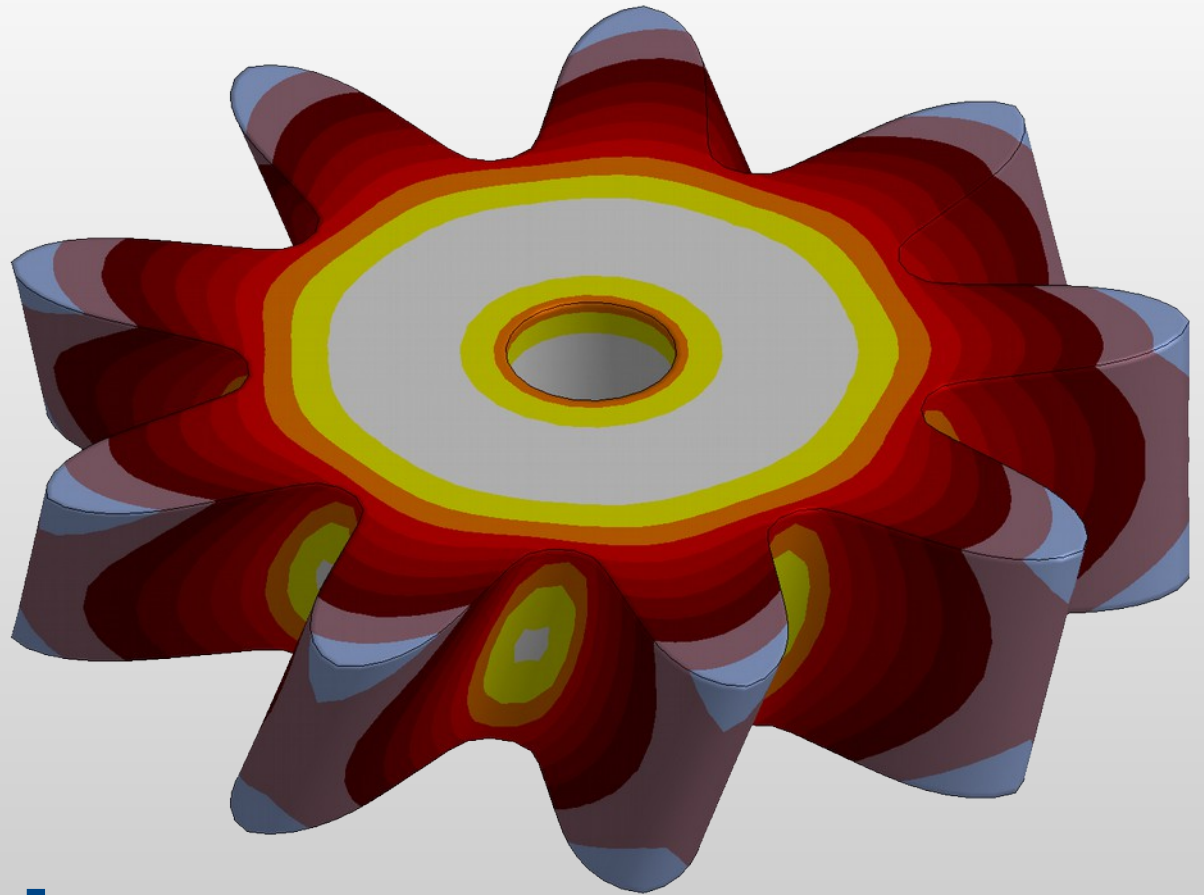

Process chain

Heat Treatment - Welding

Welding after Heat Treatment

Welding Gear # www.loose.at
Time = 1.7487

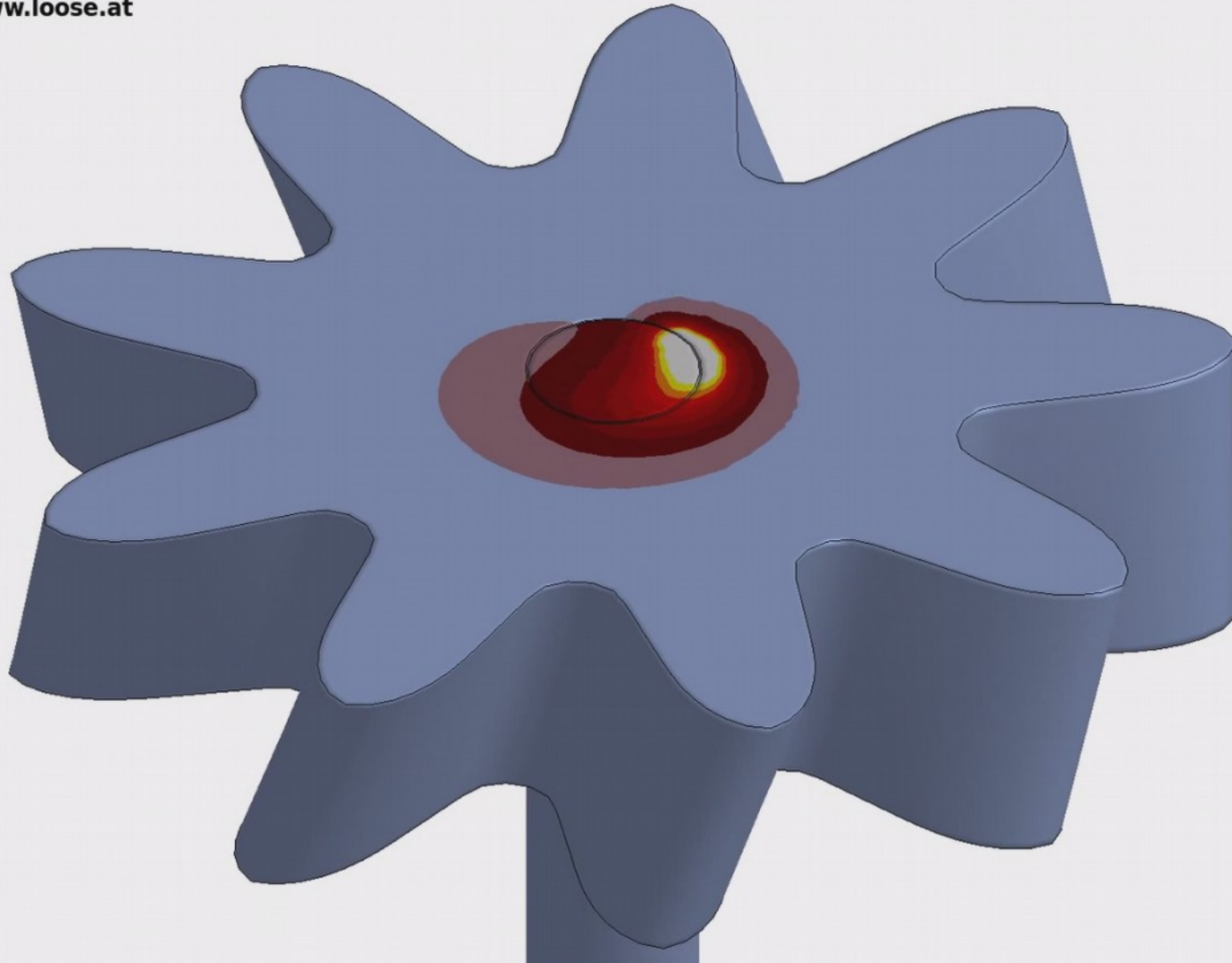

Results of Process Chain Simulation Heat Treatment - Welding

Special Contact
during Welding

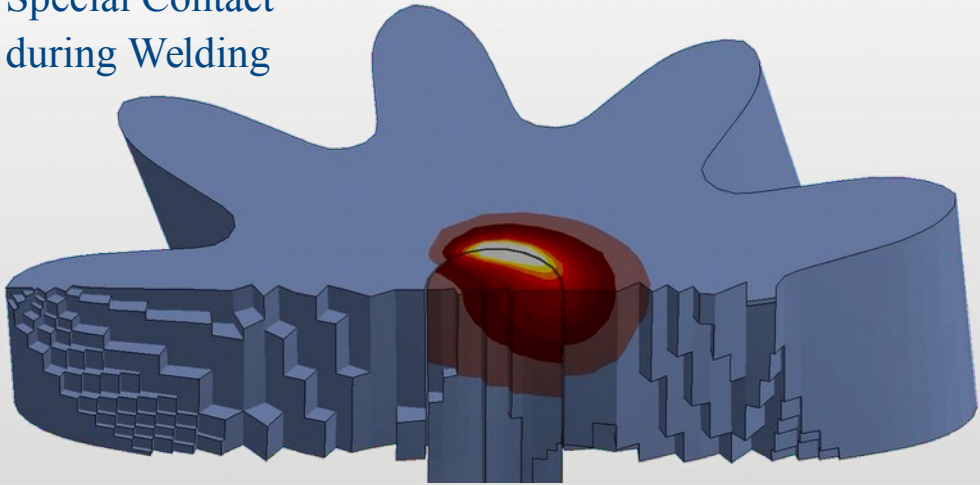

Equivalent Stress
after welding

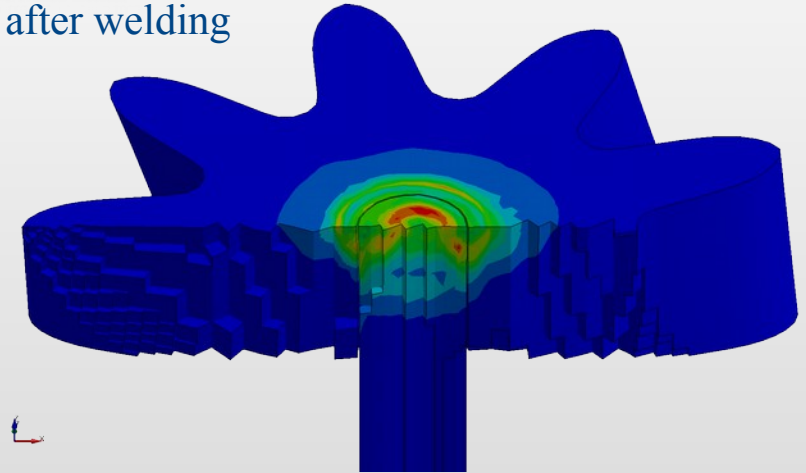

Martensit
before welding

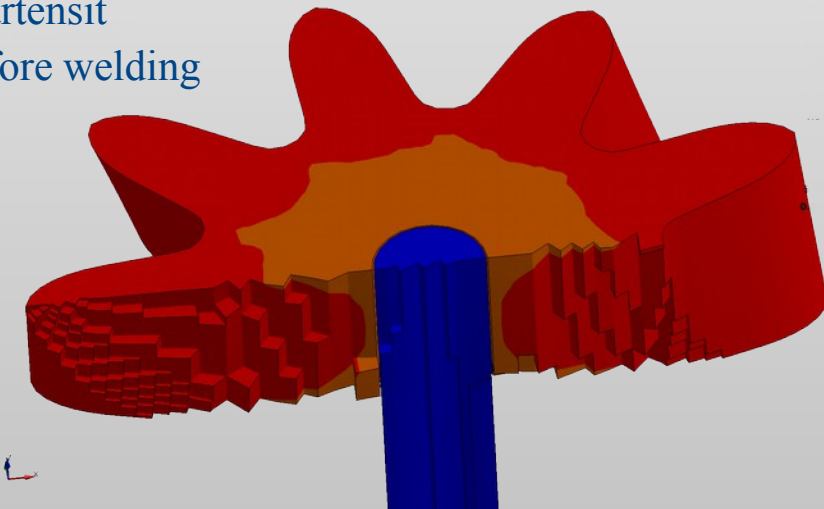

Martensit
after welding

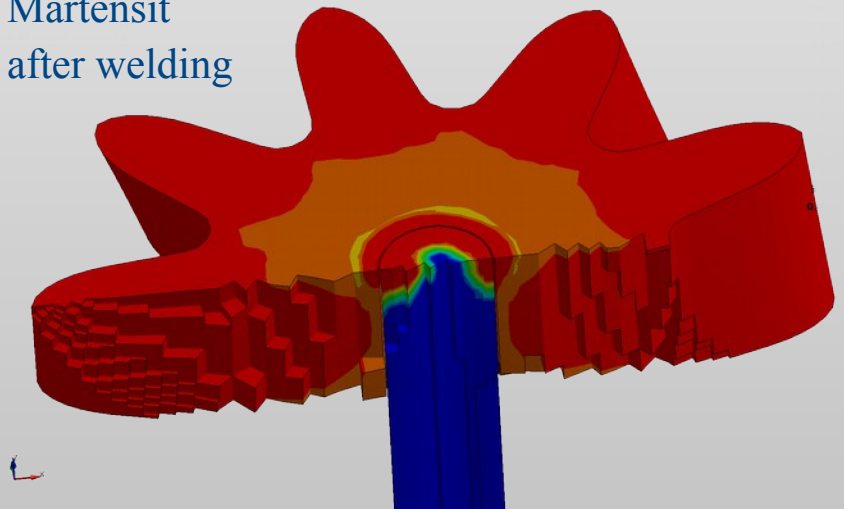

Thanks for your Attention!



Forming

Heat Treatment

SimWeld

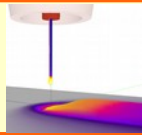

DynaWeld



Forming

Structure Analysis

**Post Weld
Heat Treatment**

Crash

Assembly

max displacement factor=5

