

A pregnant woman model to study injury mechanisms in car crashes

Authors:

Jérémie Pérès*, Michel Behr*, Lionel Thollon*, Kambiz Kayvantash**.
*IFSTTAR, **CADLM

Correspondance:

Jérémie Pérès
Laboratoire de Biomécanique Appliquée
UMRT24 IFSTTAR/Université de la Méditerranée
Faculté de médecine secteur Nord
Boulevard Pierre Dramard
F -13916 Marseille Cedex 20
Tél : +33 (0)4 91 65 80 00 - Fax : +33 (0)4 91 65 80 19
Jeremie.peres@ifsttar.fr

Abstract

Based on statistical analysis it has been estimated that 3 to 7% of pregnant women experience trauma, 2 third of those trauma are caused by car accidents. According to one epidemiologic study, the frequency of foetal losses could exceed the death frequency of children aged 0 to 4. Some numerical and experimental tools have recently been developed so as to better understand injury mechanisms leading to foetal losses, nevertheless shortcomings regarding the anatomy of the models must be outlined. Indeed they lack internal organs whereas there is a direct interaction with the uterine wall. Moreover the simplified amniotic fluid model (lagrangian) often implemented is not validated.

To fulfil the need of an anatomically precise pregnant woman model, a first finite element model of a 9 month pregnant woman has been developed and validated via a PMHS experimental approach. This model was based on the Humos 50th centile male model and a simplified model of the amniotic fluid was used (Lagrangian).

This paper will present the development and validation of the second generation of this model using the LS Dyna software. The geometry of the Humos 50th centile male model was adapted to the anatomy of a 50th centile woman using scaling techniques with a special focus on the pelvis. The model integrates the uterine wall, the foetus, the placenta and an Euler model for the amniotic fluid and represents the anatomy of a 7 month pregnant woman. The uterus is surrounded with main internal organs and bones. An improved PMHS approach was used for validation purpose. Some belt loading of the abdomen and crash tests were realized and compared to the numerical response of the model in similar loading conditions.

The pregnant numerical model exhibited a response in agreement with the PMHS tests and will be used to investigate mechanisms leading to fetal losses. A study on parameters influencing the risk of fetal loss is also projected and could ultimately lead to specific safety systems designs.

Introduction

A pregnant dummy as well as several pregnant FE models for crash investigation purpose have recently been developed. These models are based on simplified anatomical representations of the human body including the bone structure but no soft internal organs except the gravid uterus. So as to improve the realism of numerical simulations and the understanding of injury mechanisms we developed a finite element model based on a detailed human body anatomy.

The main injury mechanism leading to fetal loss after a car accident is the placenta abruption which is the separation of the placenta from the uterine wall. This separation is due to the difference in stiffness between the placenta and the uterus which eventually leads to high levels of stress at the interface and finally rupture of microvilli links, it occurs when the uterine wall sustains strains of about 60% in the placenta attach area.

The amniotic fluid can be assimilated to water (99% of water), it fills the space between the uterine wall and the foetus and is supposed to have an important protective function for the foetus in case of impact to the uterus.

The model aims at dealing with all these characteristics.

Model description

The woman model

The Humos model is a complete human body model resulting from a European project involving several car manufacturers, research center and software editors. It is based on a seated 50th centile male human body (176cm, 78Kg) and was obtained from a frozen cadaver in driving position.

It contains main internal organs including the stomach, the intestine, the liver and the spleen for the abdominal section. It has been widely validated in various impact conditions for each part of the body.

This model was not available in a LS Dyna version; We translated it from an other FE software.

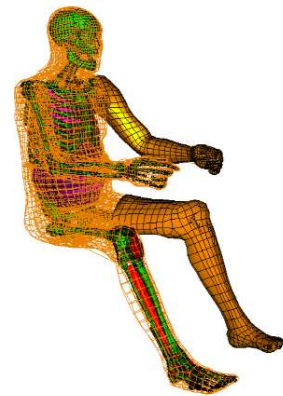

Figure 1: Humos Model

The abdomen was validated via bar impacts with different energy levels (Cavanaugh et al. 1986). The thorax and the pelvis were also validated through impact.

This model was then scaled to represent the anatomy of a 50th centile woman (162cm, 62kg) with particular focus on the anatomy of the pelvis because it is in direct contact with the gravid uterus.

To achieve this goal, anatomical target points were defined and permitted via a kriging method to obtain the final anatomy.

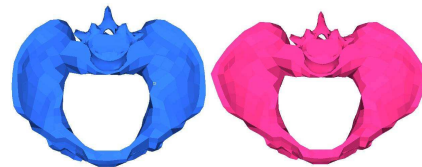

Figure 2: Comparison of the 50th centile male and female pelvis

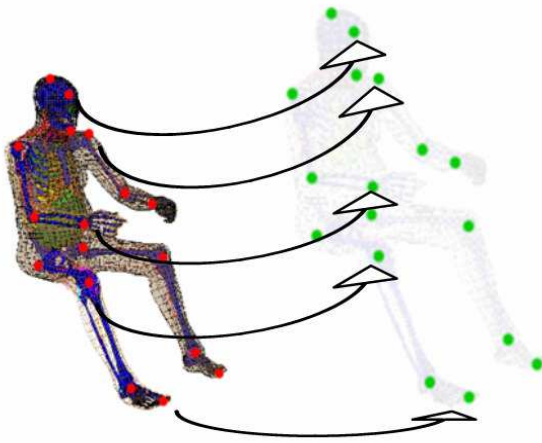

Figure 3: Scaling of the Humos model into a 50th centile woman.

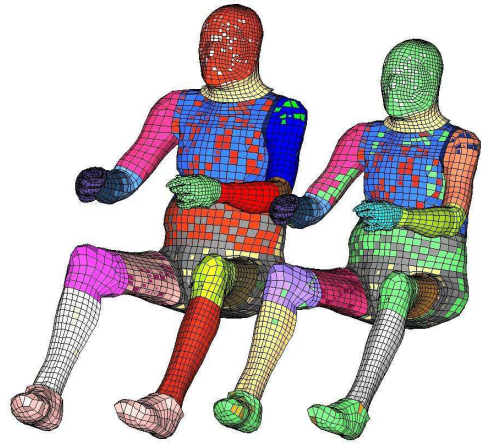

Figure 4: Comparison between 50th centile male and 50th centile woman.

The uterus

Geometry

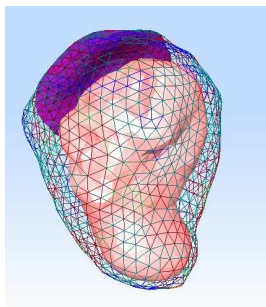

Figure 5: Gravid uterus model

MRI images were recorded on a pregnant woman near term and permitted to extract the external and internal contours of the uterus. From these contours, a mid contour was then defined and separated into different thickness areas (7 different 5 mm thickness intervals from 2.5 to 32.5mm were defined).

The uterus was scaled to account for the anatomy of a 7 month uterus.

Material model

The pregnant uterus is a muscular organ exhibiting a different behaviour in the circumferential direction and in the transverse direction.

Manoogian et al. 2008 (1) realized tensile tests on human uterus in both directions and defined an average behaviour which proved to be hyperelastic. The tensile test was reproduced via FE simulation. We decided not to account for the anisotropic behaviour and used a hyperelastic Ogden material model with 4 parameters(cf equation 1).

$$W = \frac{\mu_1}{\alpha_1} * (\lambda_{\alpha_1}^{\alpha_1} + \lambda_{\alpha_2}^{\alpha_2} + \lambda_{\alpha_3}^{\alpha_3}) + \frac{\mu_2}{\alpha_2} * (\lambda_{\alpha_1}^{\alpha_2} + \lambda_{\alpha_2}^{\alpha_2} + \lambda_{\alpha_3}^{\alpha_2}) \text{ equation 1: Ogden law with } n=2.$$

An optimisation technique permitted to determine the parameters of the Ogden law that lead to the closest Stress Vs Strain curve.

The final material model fits the stress vs strain curve of the human with a R² coefficient of 98%.

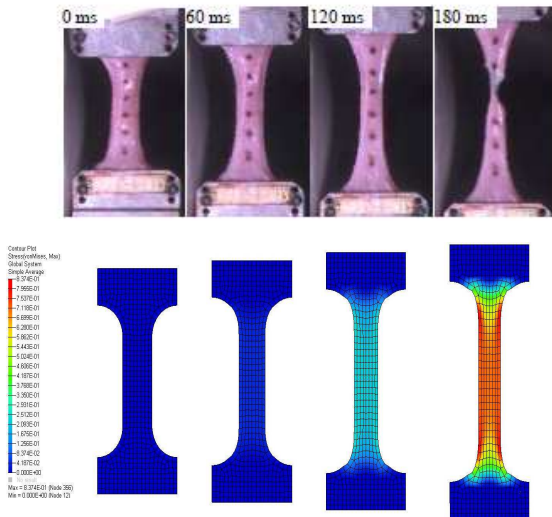

Figure 6: Tensile uterine images from experiment and simulation.

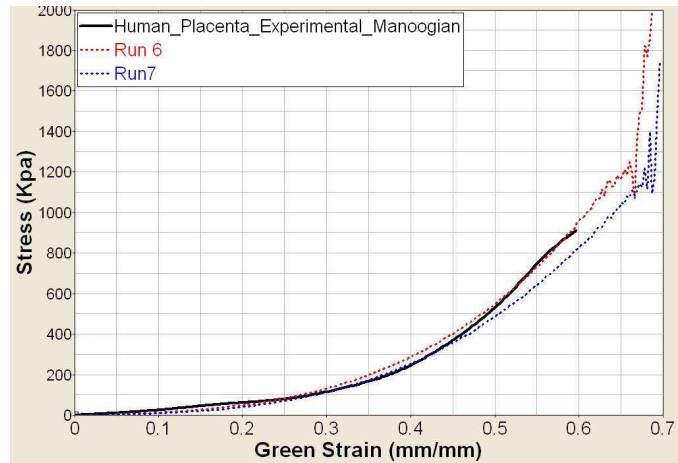

Figure 7: Optimisation best fits and experimental stress Vs Strain curve.

The placenta

Geometry

The placenta is a circular organ with diameter 150mm at seven months and maximum thickness at the central position of 35mm. It is usually (>90%) located in the superior section of the uterus. The weight of the placenta is around 300g at 7 months of pregnancy. From these anatomical data we were able to generate a realistic geometry for the placenta which was meshed using tetrahedrons. In this first model the placenta mesh is linked to the uterine wall mesh but we would like to implement in next steps separation of placenta from uterine wall via a tiedbreak interface.

Material model

Manoogian et al. 2008 (2) studied the mechanical behaviour of the placenta in tension, and found that it exhibits a hyperelastic behaviour that is softer than the uterine wall, they also proved that the behaviour is similar in quasi static and dynamic loading meaning that there is no significant viscosity effect.

Because this organ can be subjected to compression in case of an impact we decided to launch an experimental campaign on fresh placentas. Indentation tests were realized on 70 fresh placentas within 1 hour after deliverance. We found stiffness response in accordance with the tensile behaviour of the placenta suggesting that the behaviour of the placenta is nearly symmetrical between tension and compression.

2 FE models were developed to represent both tensile and indentation experimental tests. An inverse analysis method was used to fit the stress vs strain behaviour of the organ.

An Ogden law with 4 coefficients was used and 3 optimisations procedure were compared:

- Optimising parameters on the tensile FE model.
- Optimising parameters on the Indentation FE model.
- Optimising the parameters for both loading conditions at the same time.

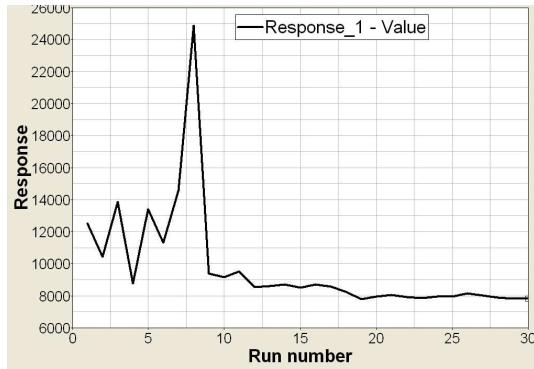

Figure 8: Response vs run Number for the third optimisation method

For the first method we succeeded in fitting the tensile experimental curve but when we used the parameters from the optimisation with the indentation model there was a significant difference with experimental data, the simulation giving stiffer behaviour.

For the second method, the indentation behaviour was fitted but the same parameters used in the tensile simulation gave bad results.

The last method gave us a good fit in both tension and indentation and the material parameters from this optimisation were then selected for the placenta material law.

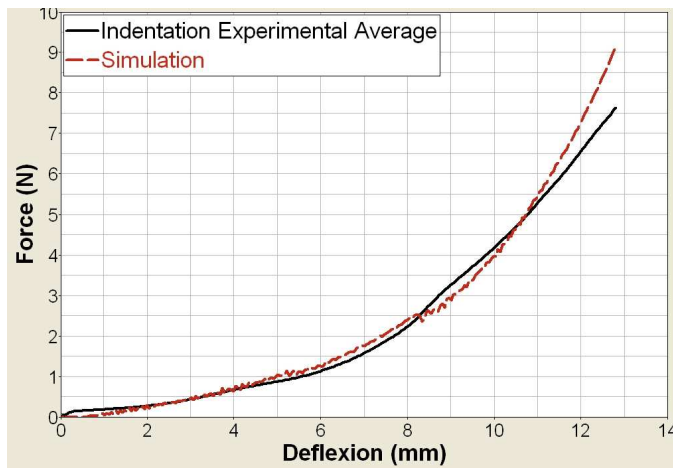

Figure 9: Placenta indentation Force Vs Deflexion for experimental test and simulation.

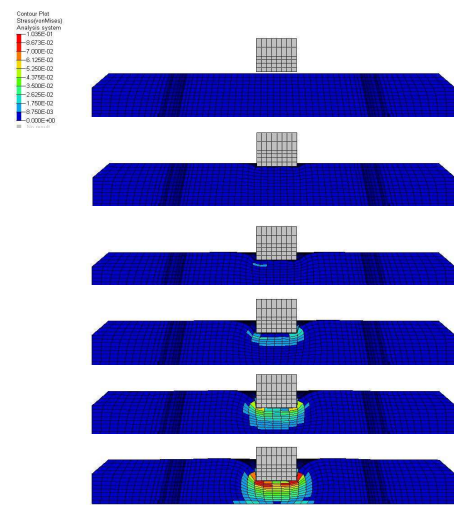

Figure 10: Indentation simulation

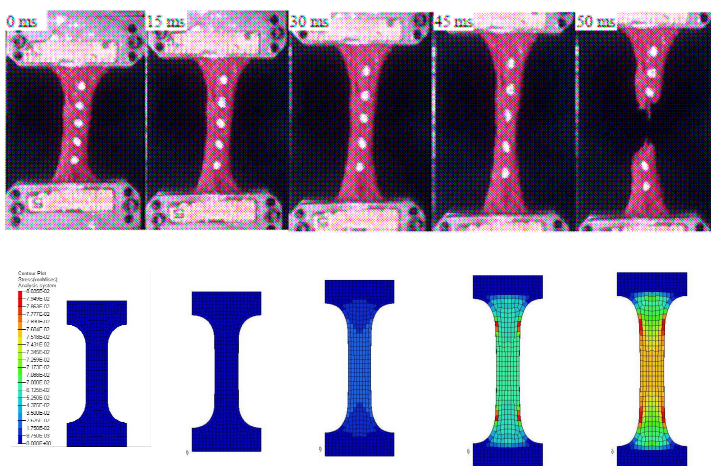

Figure 11: Placenta tensile images from experiment and simulation.

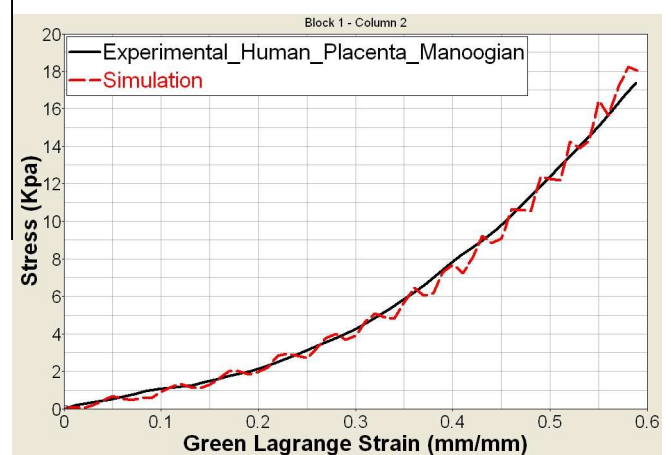

Figure 12: Placenta tensile Stress Vs Strain curve for experimental test and simulation.

The foetus

Geometry

The foetus geometry was extracted from the same MRI images as the uterus model. It was meshed using tetrahedrons.

Material model

Because of the lack of anatomical data on internal organs and bones anatomy of the foetus, it was not possible to integrate a fully detailed model of the foetus. We decided to model the foetus as a uniform isotropic part with a material stiffness midrange between bones and soft tissues.

The amniotic fluid

Volume

The volume of the amniotic fluid varies during pregnancy; it fills the whole space between the uterine wall and the foetus.

Methodology

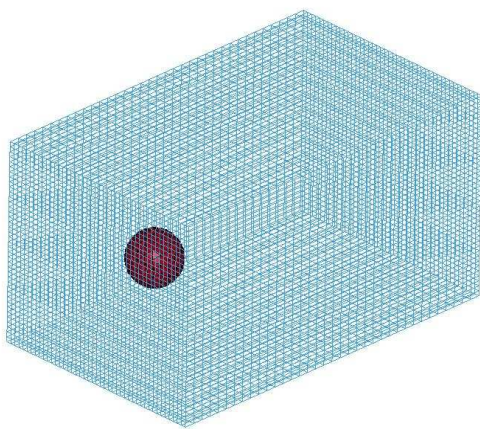

Figure 13: Simulation Model for fluid structure investigation

We realized several tests on a simplified model of a sphere moving with constant velocity in a water domain. 4 modelling techniques were used to simulate the fluid: Lagrangian, Euler, SPH and ALE. Several parameters were varied and the results of the simulations were analyzed via 4 criterions given by theoretical data from the literature: The initial force on the sphere, the stabilized force on the sphere, the pressure distribution and the velocity distribution around the sphere, we also took the stability of the calculation as a criterion.

From the analysis it appeared that the use of an Euler formulation (elements type 11 without advection) with *MATERIAL_NULL and EOS_LINEAR_POLYNOMIAL for the water was well suited for our application.

The interface between the fluid and the surface of the sphere was defined via the option *CONSTRAINED_LAGRANGE_IN_SOLID.

The ratio between fluid mesh and structure mesh was 1/2 which permitted to overcome too much leakage and to obtain correct time steps.

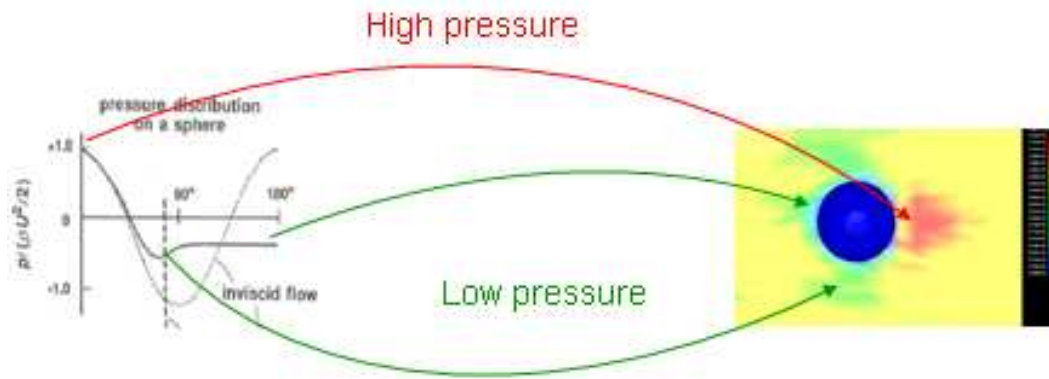

Figure 14: Theoretical Pressure distribution and euler simulation pressure distribution comparison.

In the final model, a cubic volume containing the uterus was defined and meshed using hexaedrons. This mesh aims at containing the fluid, the option `*INITIAL_VOLUME_FRACTION_GEOMETRY` was used to fill in the space between the uterine wall and the foetus with water and the rest of the cube with gaz.

To prevent the uterus from going outside the fluid cube the option `*ALE_REFERENCE_SYSTEM_GROUP` was defined to link the displacement of the fluid cube to the displacement of the uterus.

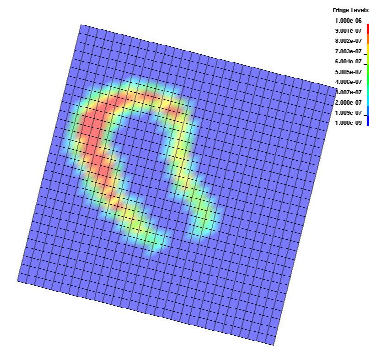

Figure 15: Water filling the space between uterus and foetus

The pregnant woman model

Construction

To push the organs of the Humos model and create the space for the uterus we used an `*AIRBAG_SIMPLE_AIRBAG_MODEL`. The surface of the airbag was meshed using triangular shell elements and a material type `*MAT_FABRIC` was defined. The final shape of the uterus was positioned relatively to the bone structure, defined as rigid and interfaced with the airbag only. The final external contour of the belly from Klinich et al.1999 was also positioned and interfaced with the skin.

For stability purpose it was necessary to reduce the timestep (`*CONTROL_TIMESTEP`) and increase the thickness of the airbag contact.

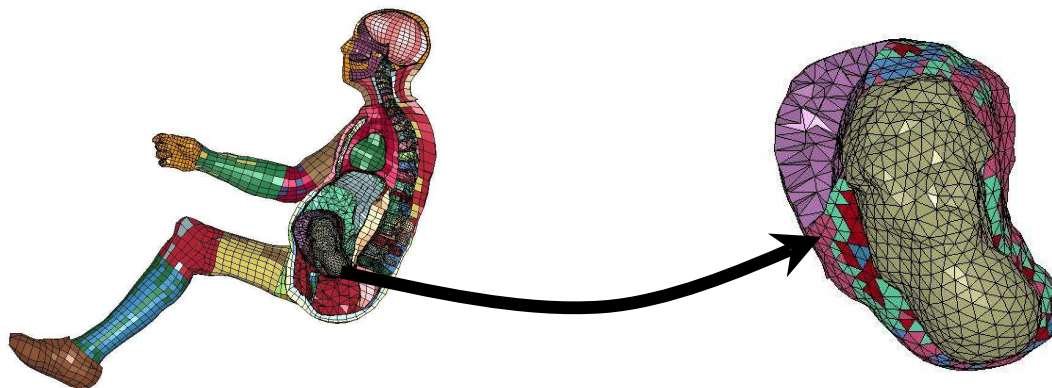

Figure 16: Final pregnant woman model and pregnant uterus detail

Results

PMHS Approach



Figure 17: Artificial silicone uterus

For obvious ethic reasons, it is not possible to use pregnant women bodies for testing. Post Mortem Human Subjects were used as a reference to validate our model. An artificial uterus was inserted into a woman body via laparotomy. The uterus was made of silicone. The women bodies were selected because they matched 50th centile women characteristics (size 162cm, weight: 62Kg). The silicone uterus was filled with 1L of water and a foetus dummy. Two kind of testing were then realized, belt loading of the abdomen and frontal car impact. The results from these 2 tests were used for FE model validation.

Belt loading of the abdomen

These tests were used to validate the mechanical behaviour of the abdomen.

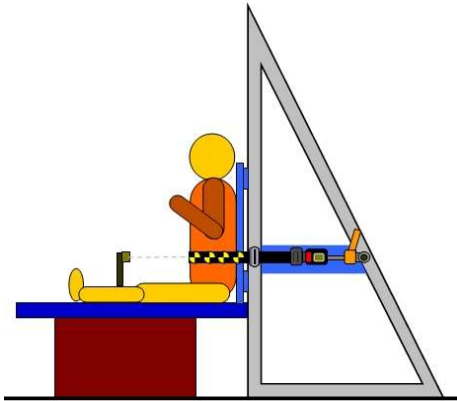

Figure 18: Belt loading experimental test

The abdomen of the subject was loaded with a lap belt pulled by 2 seatbelt pretensioner placed on each side of a lap belt. Acceleration and force sensors were used on both seatbelt sides and permitted to record a Force Vs Deflexion curve. Pressure sensors were inserted in the pregnant uterus on the left side because it was on this side that the space between uterine wall and foetus was greater which permitted us to avoid mechanical contact with any part and be sure to measure the liquid pressure.

So far 4 belt loading tests were realized.

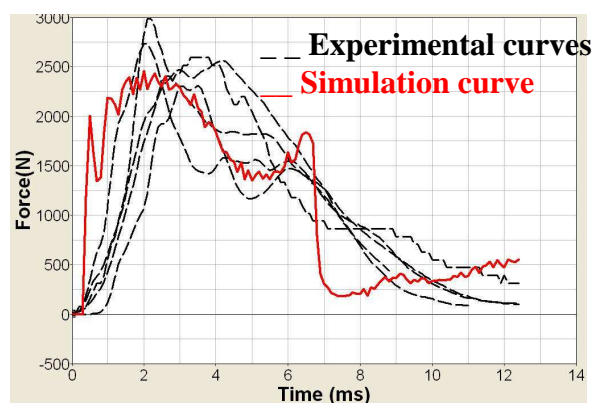
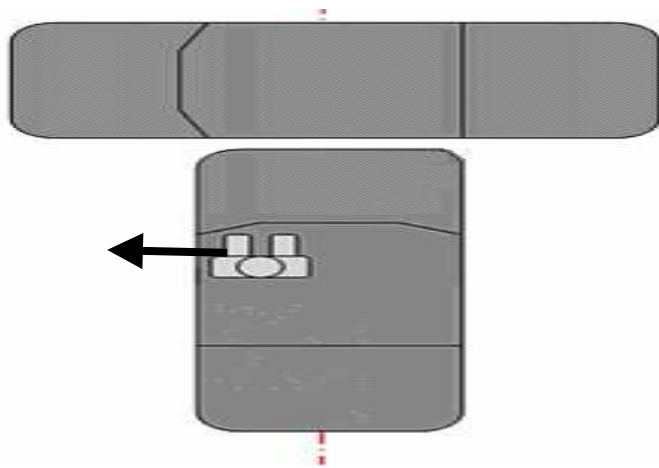

Figure 19: Belt loading Force Vs Time curve for experimental test and simulation

As shown on the curve figure 19, the behaviour of the simulation is in good agreement with the experimental curves. The maximum force recorded for the simulation is 2400N which is nearly the average max force of experimental curves. What's more the simulation curve exhibits 2 maximums which is the same pattern as most of the experimental curves. The loading stage as well as the unloading stage is somehow stiffer in the simulation which has not been yet explained.

Frontal car impacts

These tests aimed at validating the kinematical behaviour of the FE model.



The PMHS was seated in a midsize car. The car impacted laterally a second car with a velocity of 20Km/h. Multiple physiologic accelerations were recorded via (50G) accelerometers.

High speed cameras permitted to record a lateral view of the impact. An autopsy was realized after each test and revealed no injury to the abdominal segment of the woman.

Figure 20: Frontal crash test configuration

For the simulation a sled model was designed and the pregnant woman was installed using a gravity load during 20 ms.

The belt fit capabilities of LS prepost were used to fit a seat belt to the body. The velocity recorded on the vehicule during the real crash test was imposed to the sled. *CONTACT_AUTOMATIC_SURFACE_TO_SURFACE contacts were defined between belts and body parts.

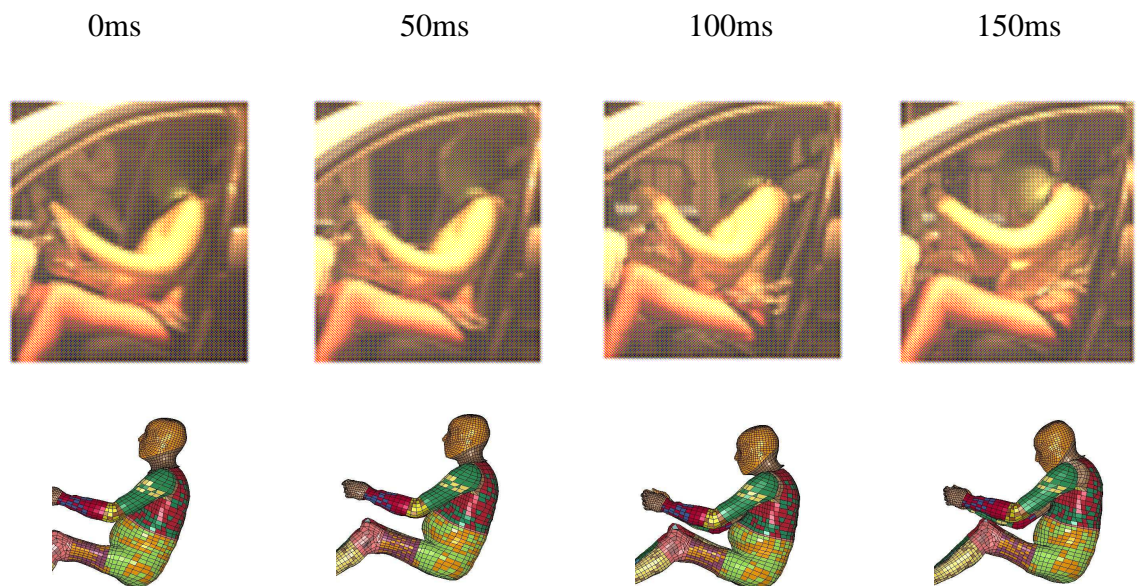

Figure 21: Images of experimental crash test and simulation sled test.

In the first 50ms seconds the body is submitted to a forward translation relative to the seat, then the thorax begins to rotate forward and the body is finally rejected against the back seat.

The model didn't show any sign of injury to the abdominal segment.

The uterus didn't sustain high strain and the placenta uterus interface was not particularly loaded suggesting that the risk of placenta abruption was very low which is in agreement with rupp et al. 2001 who suggests an adverse foetal risk of less than 20% in 20km/h frontal impact for a properly restrained woman.

Conclusion

A new detailed 7 month pregnant woman model was developed integrating Ogden material Laws for the uterus and the placenta. The amniotic fluid was represented using an Euler model. The model is already partially validated against PMHS experimental tests, further validation is needed especially comparisons with existing models. This model aims at understanding injury mechanisms leading to foetal death and eventually leading to new pregnant women specific safety systems designs.

References

S. J. Manoogian, C McNally, J. D. Stitzel, S. M. Duma “Dynamic biaxial tissue properties of pregnant porcine uterine tissue” *Stapp Car Crash J* 52 ():167-85 (2008).

S. J. Manoogian, J. A. Bisplinghoff, C. McNally, A. R. Kemper, A C Santago, and S. M. Duma, “Dynamic tensile properties of human placenta.” *Journal of Biomechanics.*; 41(16):3436-3440 (2008).

K. D. Klinich, L. W. Schneider, B.A. Eby, J.Rupp, M. D. Pearlman “Seated Anthropometry During Pregnancy” *Report UMTRI-99-16*. (1999)

J. M. Cavanaugh, G. W. Nyquist, S. J. Goldberg, A. I. King. “Lower abdominal tolerance and response”. *SAE Transactions ISSN 0096-736X*, 95(5), pp. 5611-5633. (1986).

J. D. Rupp, K. D. Klinich, S. Moss, J. Zhou, M.D. Pearlman, L.W. Schneider. “Development and testing of a prototype pregnant abdomen for the small-female Hybrid III ATD”. *Stapp Car Crash Journal*, 45, 61-78. (2001).