

Optimierung von Kunststoffbauteilen im Crash: Status und Ausblick

Torsten Hensel – BASF SE

Dr. Steffen Frik, Opel AG

Andreas Wüst, BASF SE

Dr. Stefan Glaser, BASF SE



Wir leben Autos.

 **BASF**

The Chemical Company

- Motivation
- Material modelling of Short fibre reinforced thermoplastics for Crash
- ULTRASIM™ examples and applications at OPEL
- Modelling Energy absorbing structures out of glass-filled thermoplastic materials
- Vision → Integrative Approach
- Summary

Motivation Application of Polymers

- More and more structural components are made of polymers (e.g. short fiber reinforced polymers)
- These materials show significant anisotropy due to fiber orientation caused by injection molding
- In order to predict component behavior, kinematics and structural response with required accuracy, anisotropy must be captured

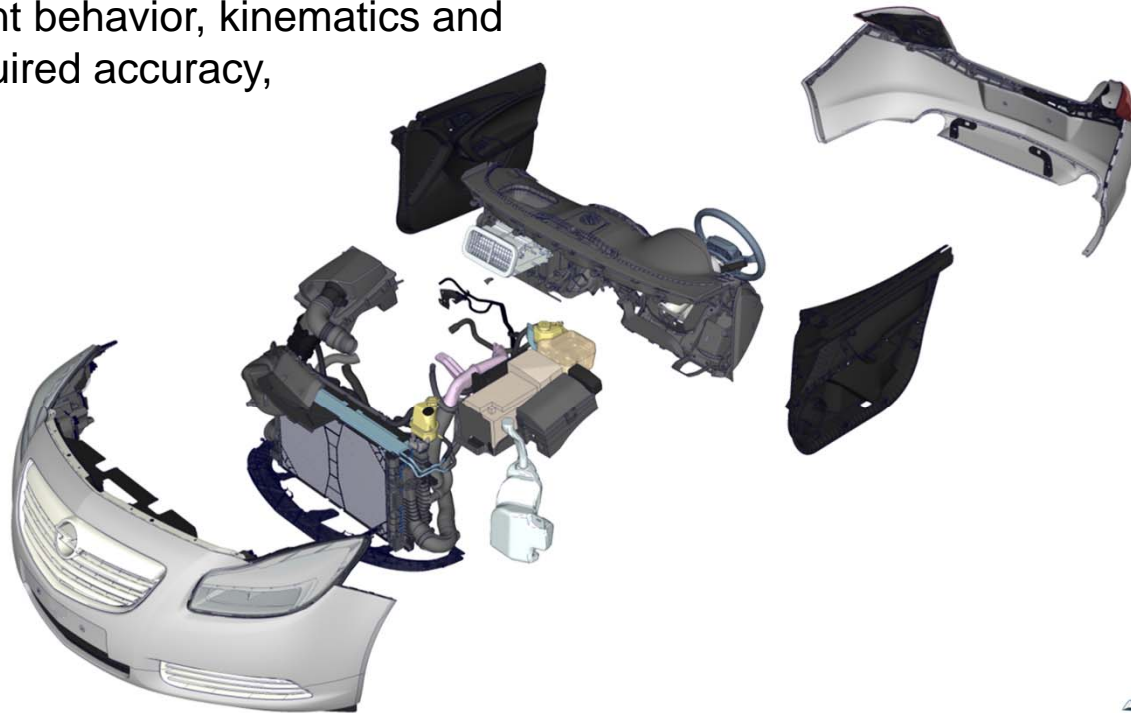

Lower Bumper Support

Development targets:

- Optimized, ribbed plastic structure to provide sufficient support for lower leg during the impact
- Needs to fail in a controlled manner during RCAR impacts in order not to damage other components
- Low weight at reasonable costs

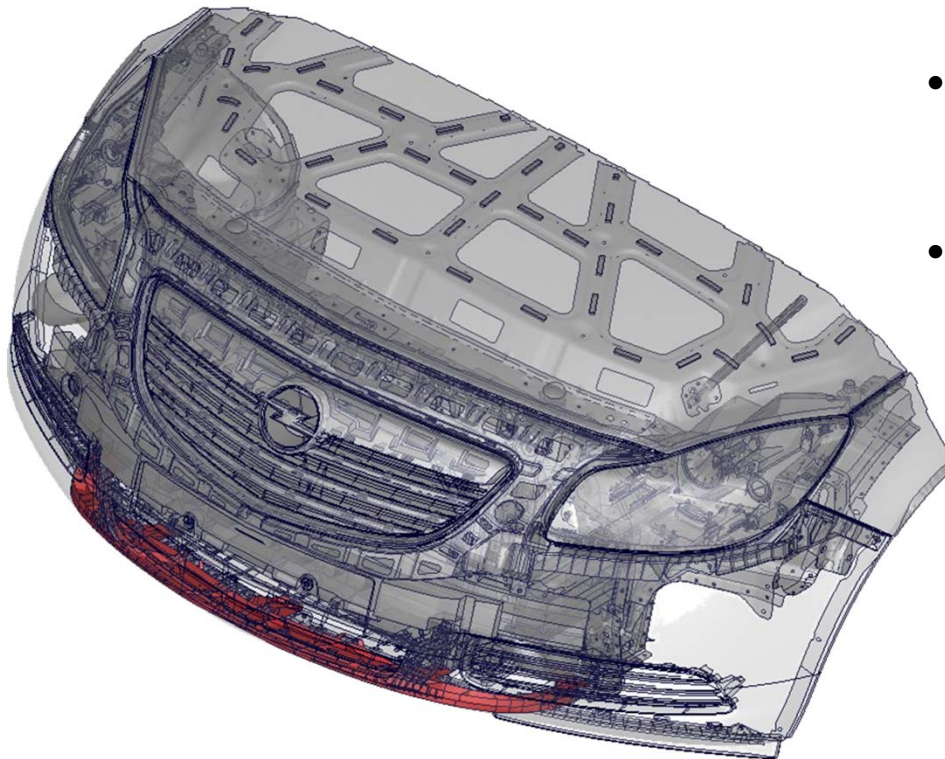

Lower Leg Impact Kinematics

Without Lower Bumper Support

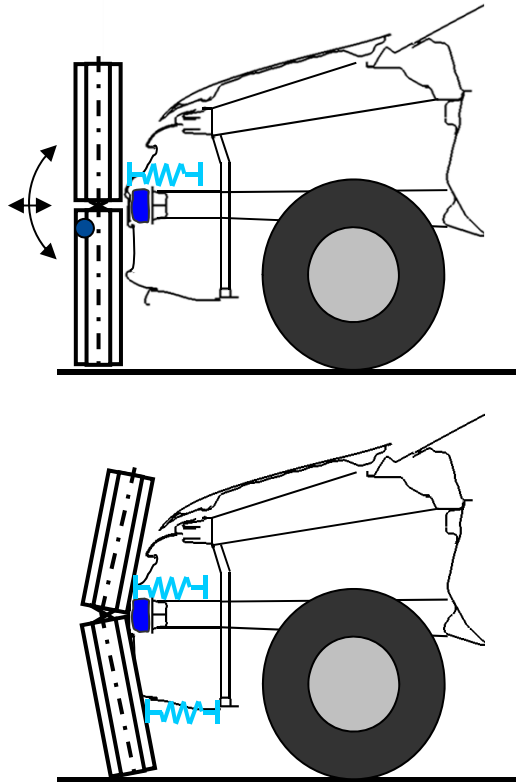

No support of lower leg

With Lower Bumper Support

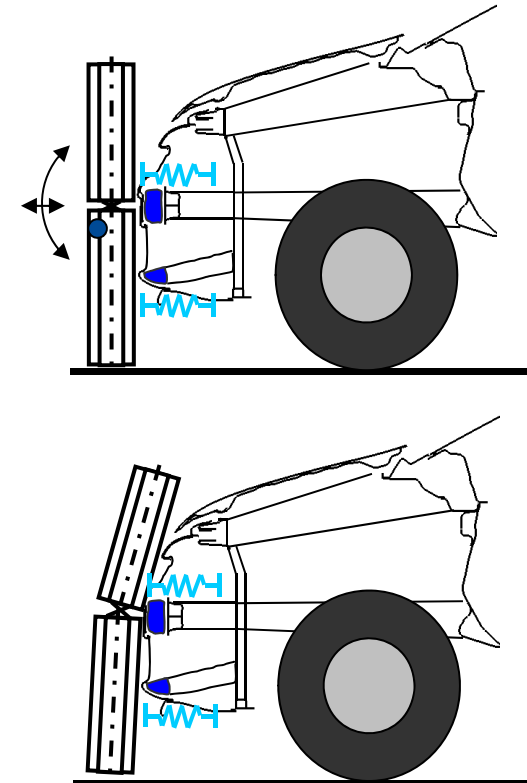

Support lower leg,
reduce knee bending angle

Lower Leg Impact (Full Model)

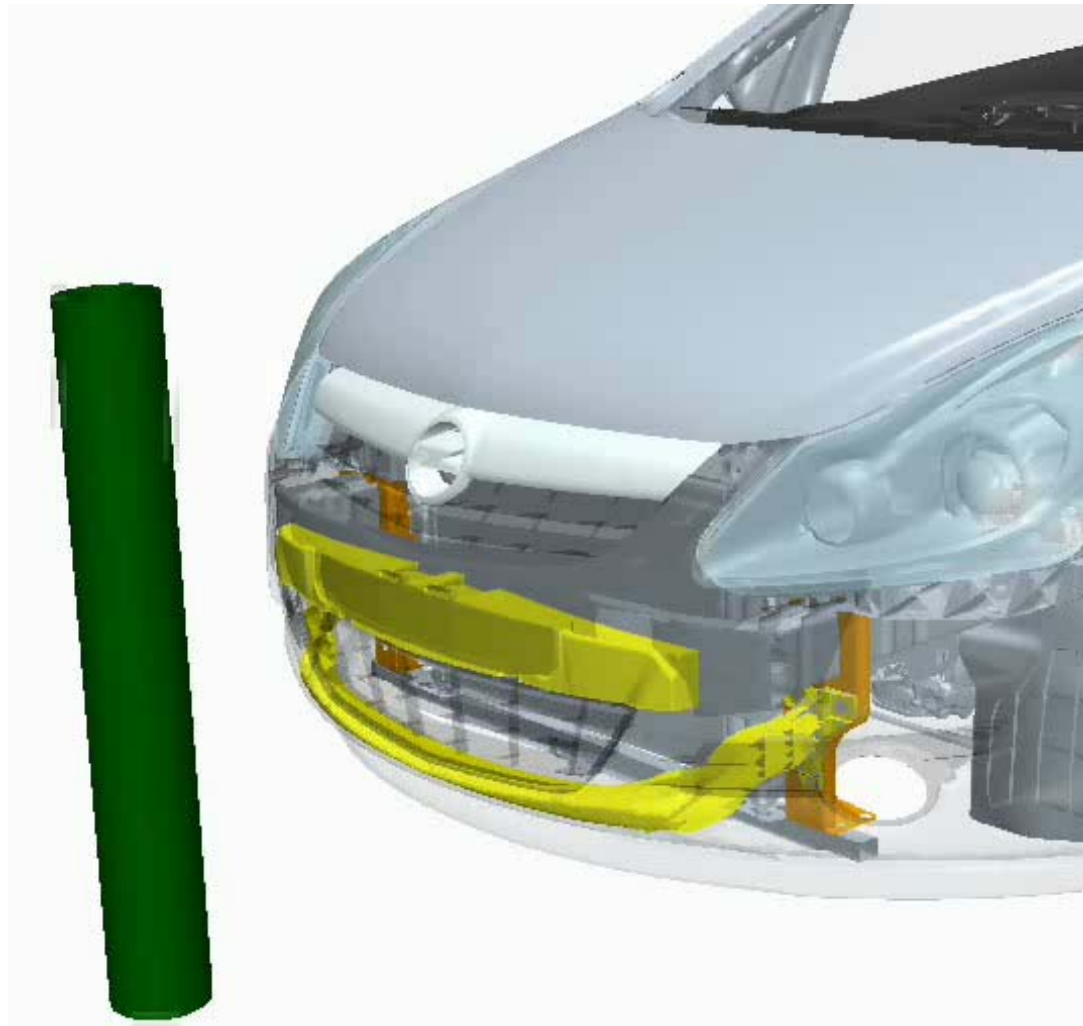

Simulation Results

Impact on stiffness and rupture

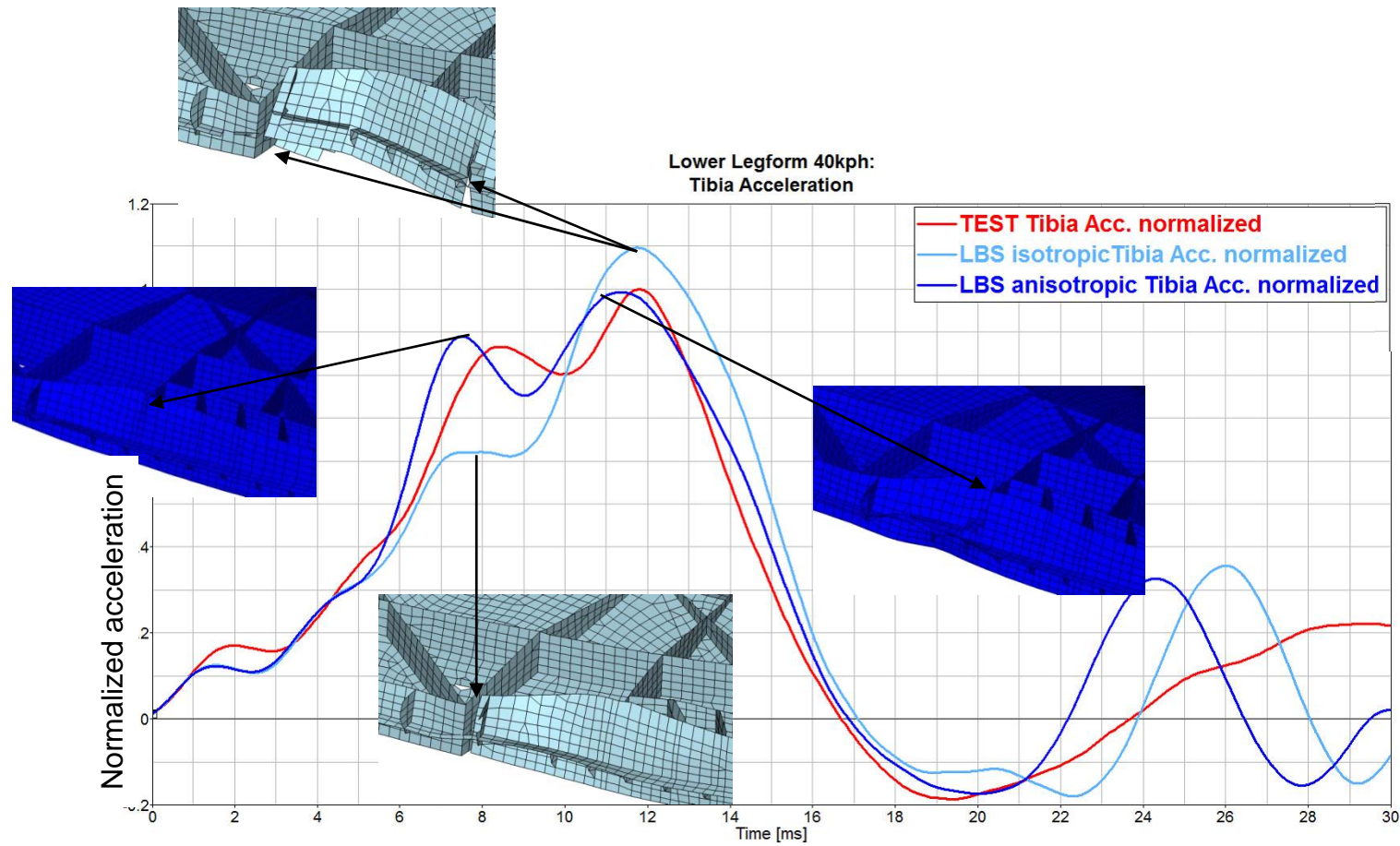
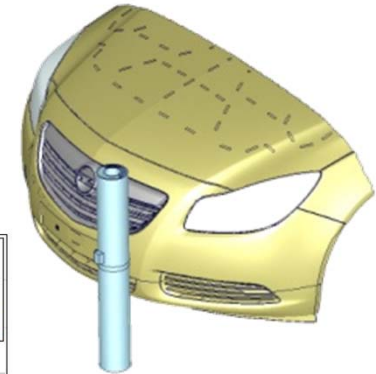

Integrative Simulation ULTRASIM™ for fiber reinforced thermoplastics

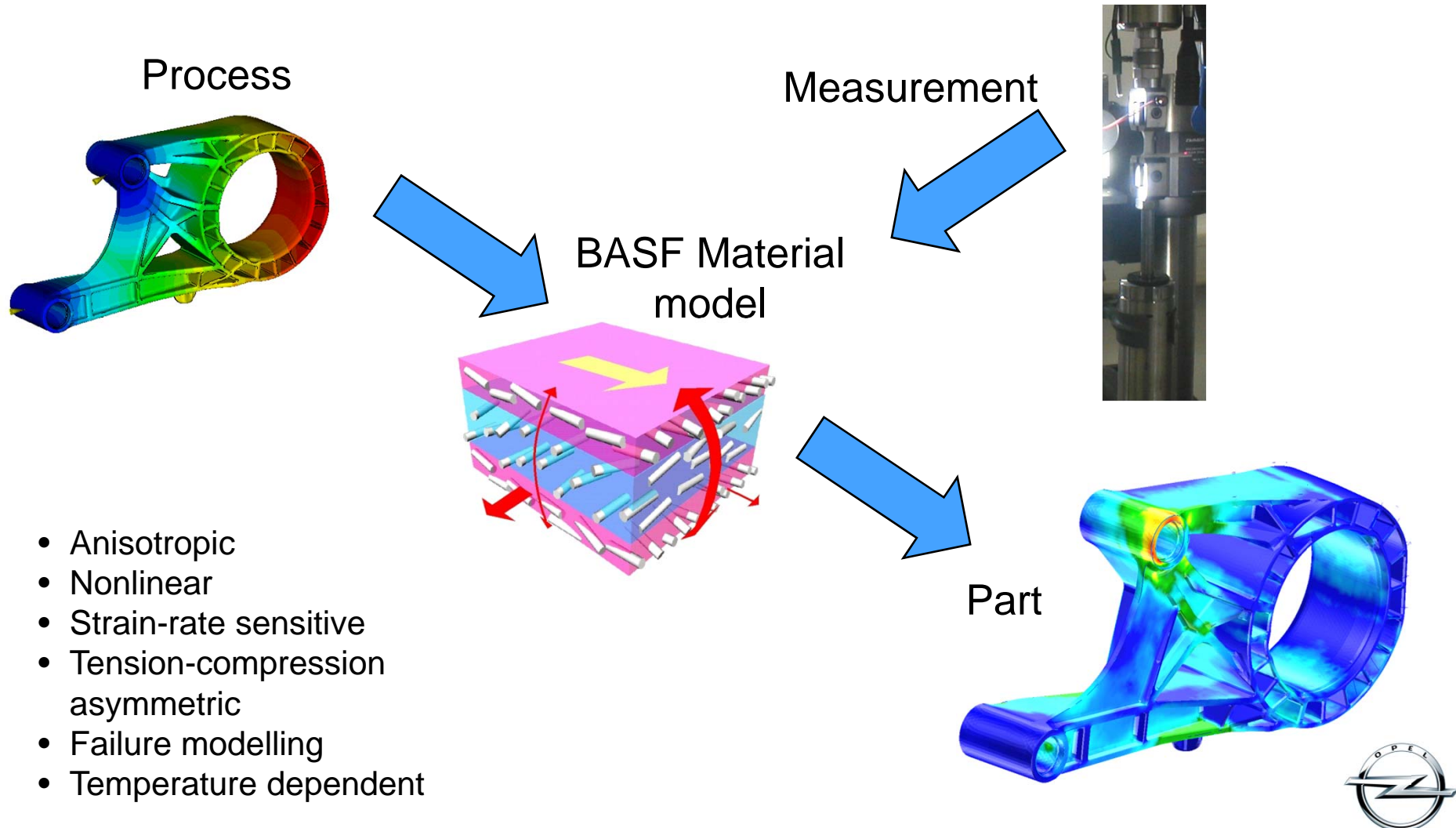

Integrative Simulation ULTRASIM™

Fiber orientation and material behaviour

Calculated glass fiber orientation based on optimum processing conditions

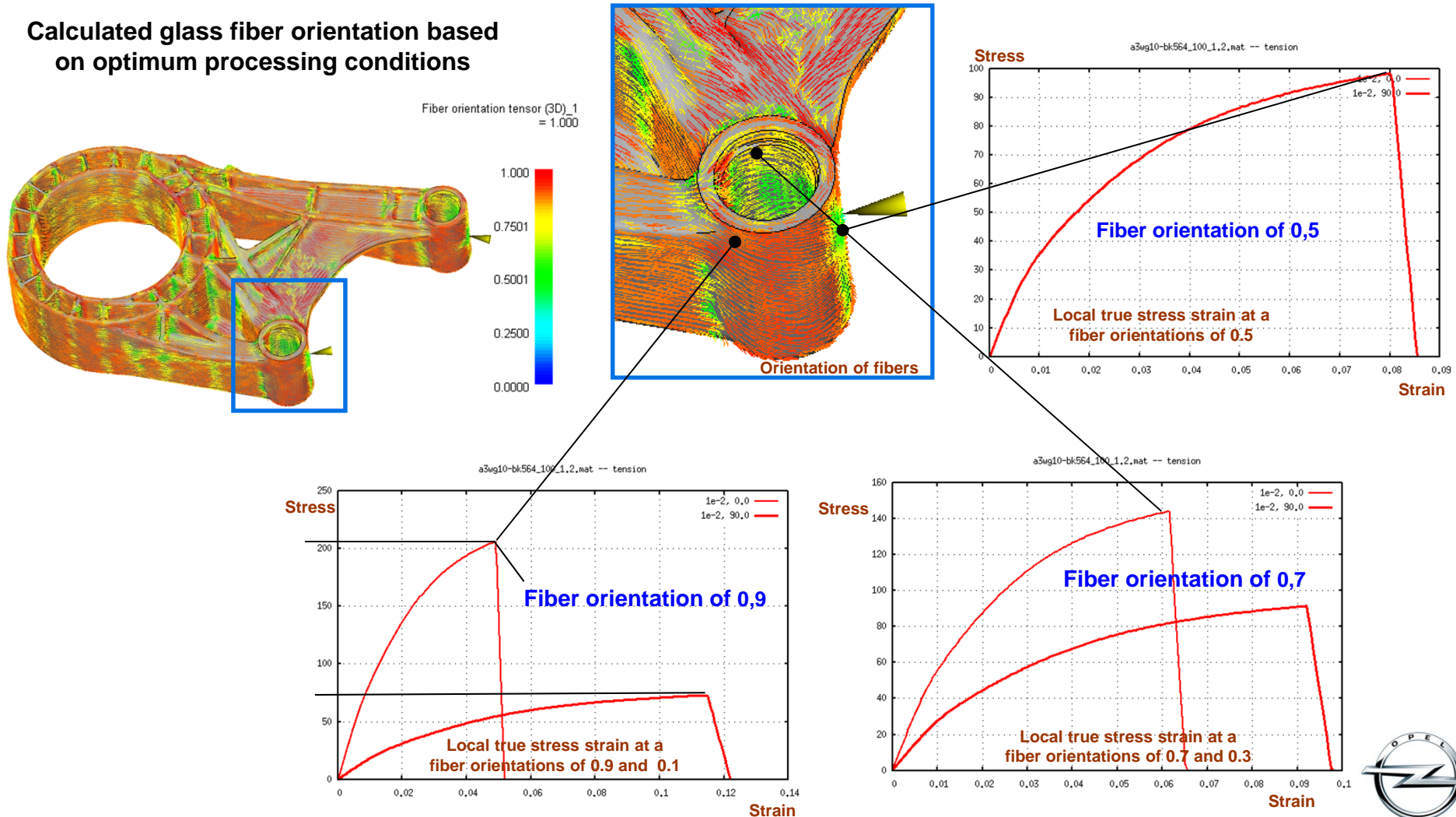

Integrative Simulation ULTRASIM™

Data flow structure

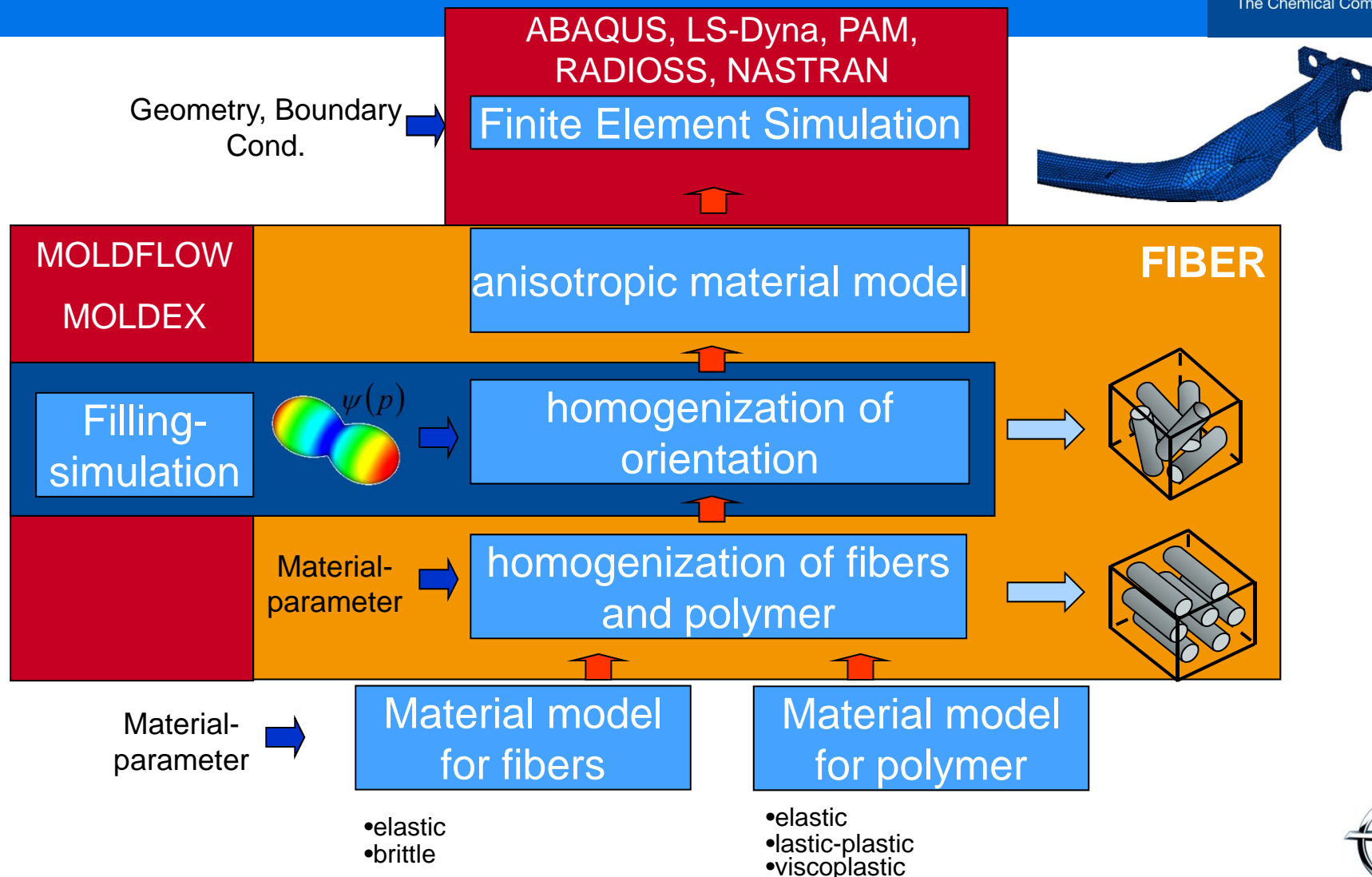

LBS Implementations

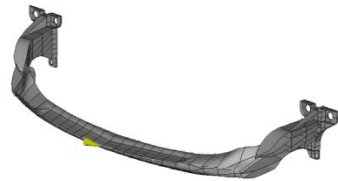

2006



2008



2009

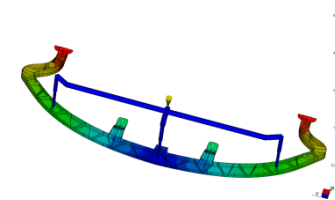

2010

Additional Applications

- Engine Mounts (e.g. Insignia)



- Special Seats (e.g. Insignia OPC)



Stress-Strain behaviour Tension-Compression Asymmetry

influence: fiber orientation
and hydrostatic stress state

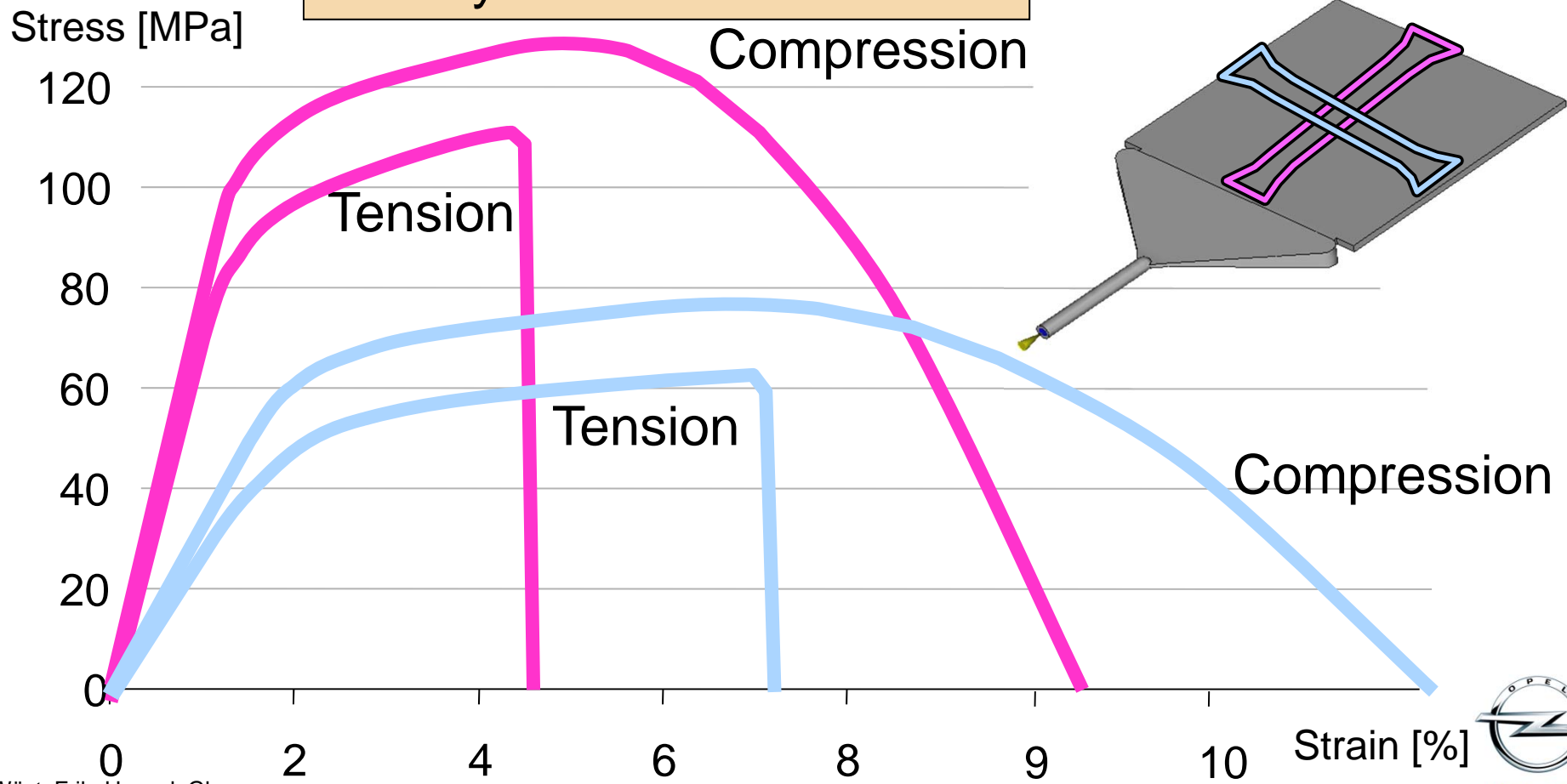

Example for an Energy absorbing plastics structure – BASF Test Specimen for compression load Needed for Calibrating Failure Simulation Parameters

Specimen is designed for controlled collapse

Material: B3WG6 CR (PA6 GF30%)

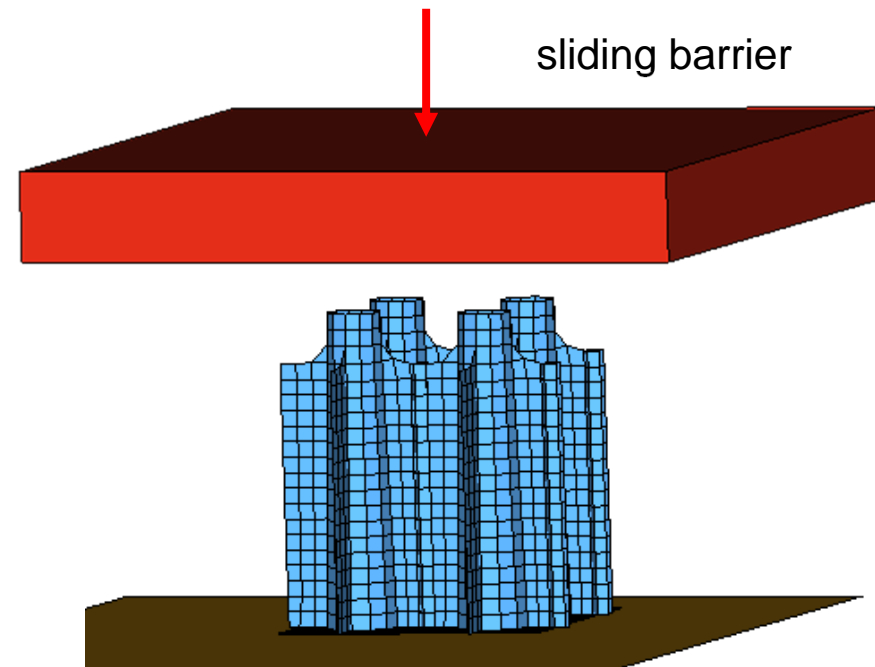
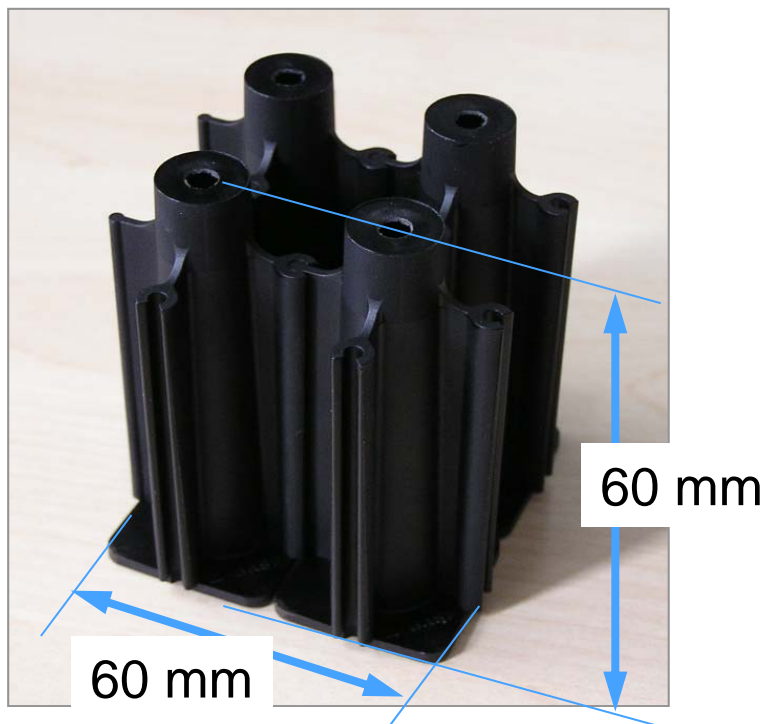

Plastic specimen under compression load

Simulation and Experiment

 **BASF**
The Chemical Company

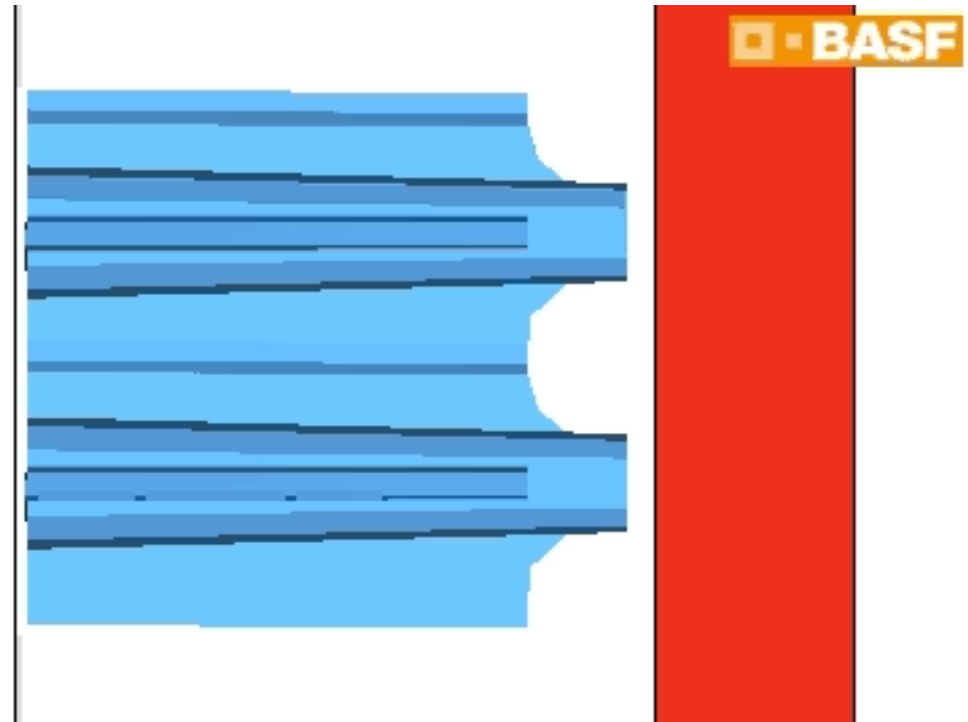
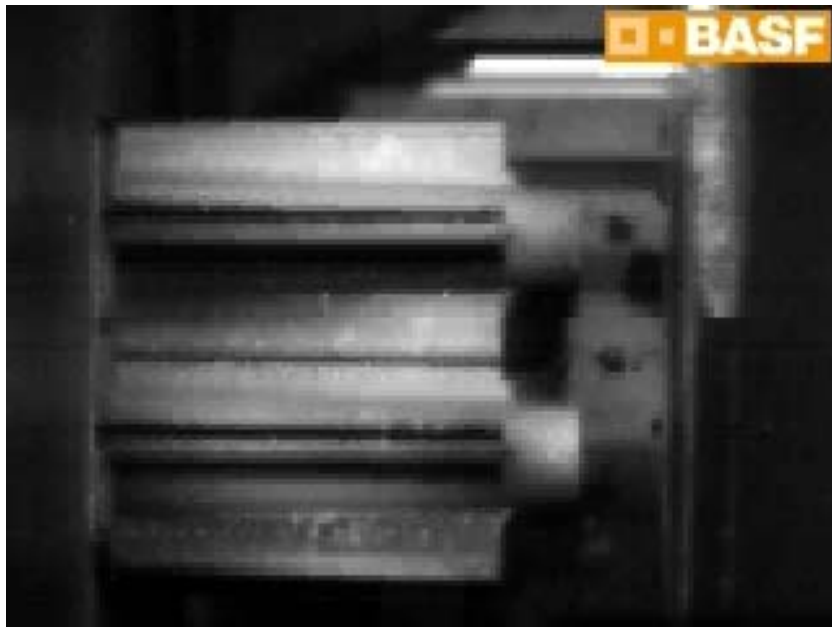

Test-specimen under compression load

Simulation and Experiment



60 mm

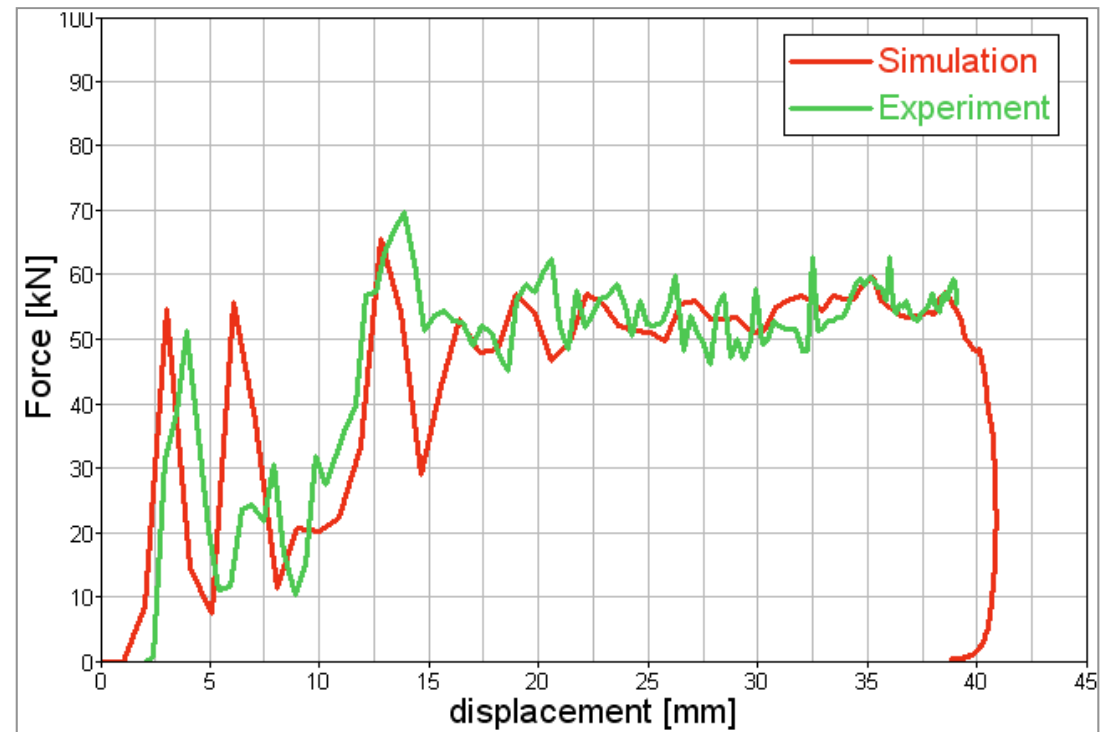

Lower Loadpath

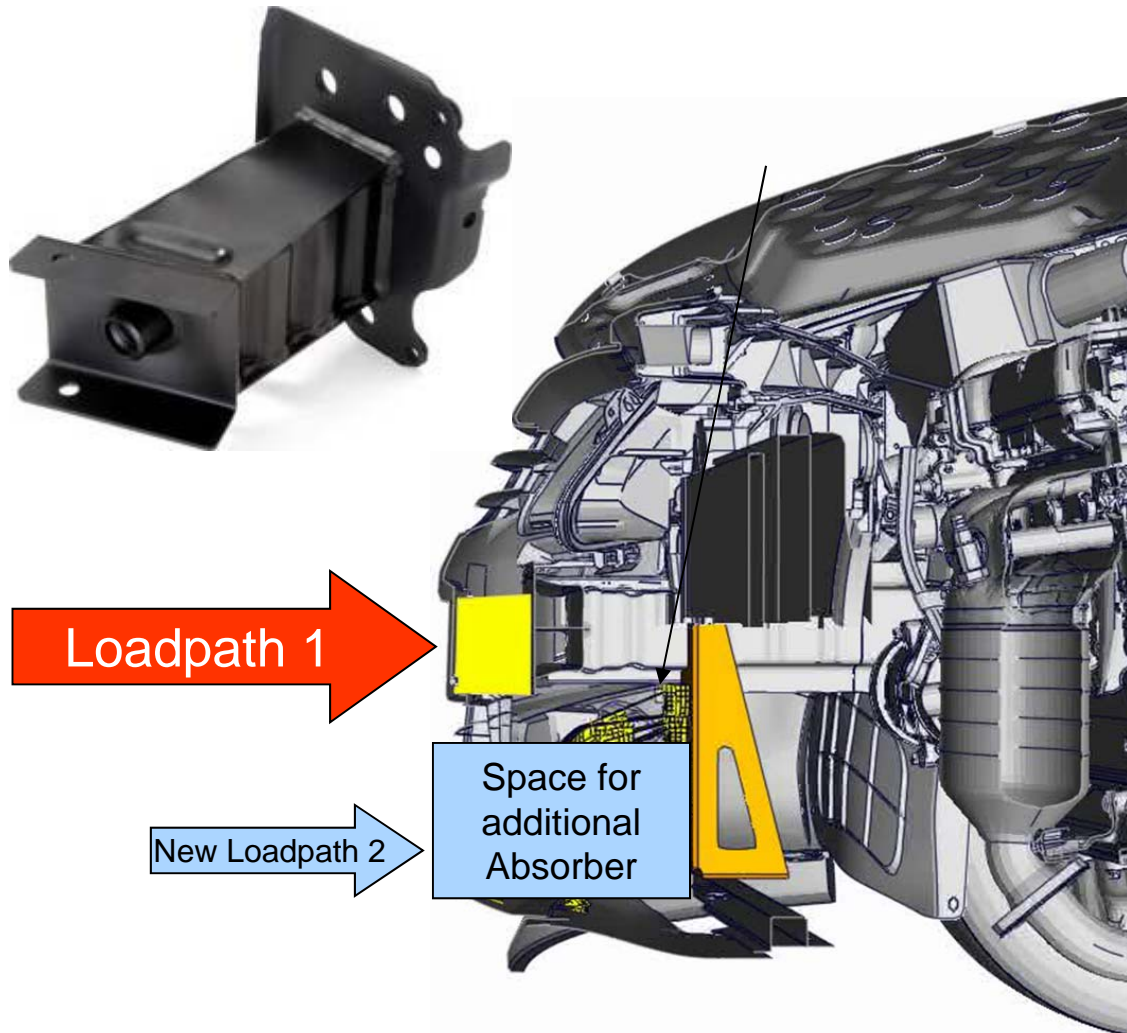

Traditional
Metal Crashbox:

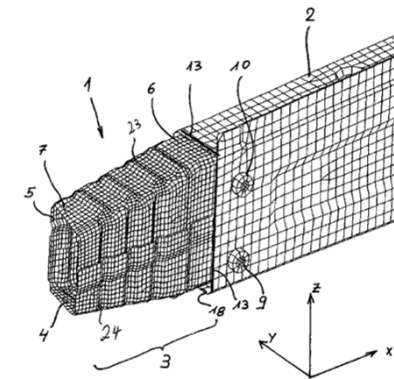

Videocomparison Absorber

→ enhanced ULTRASIM™ failure modelling

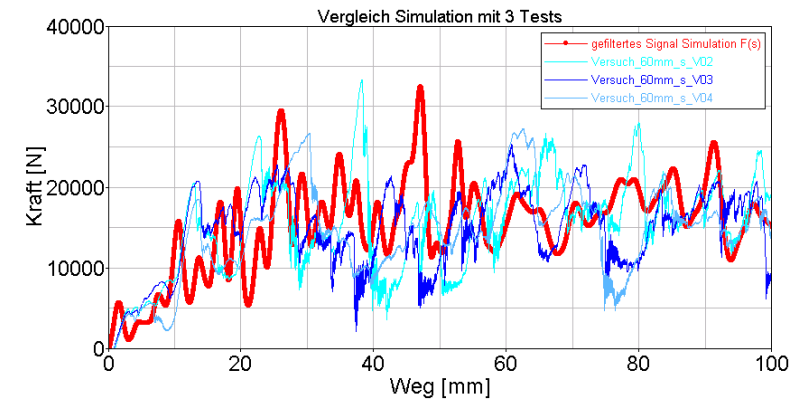
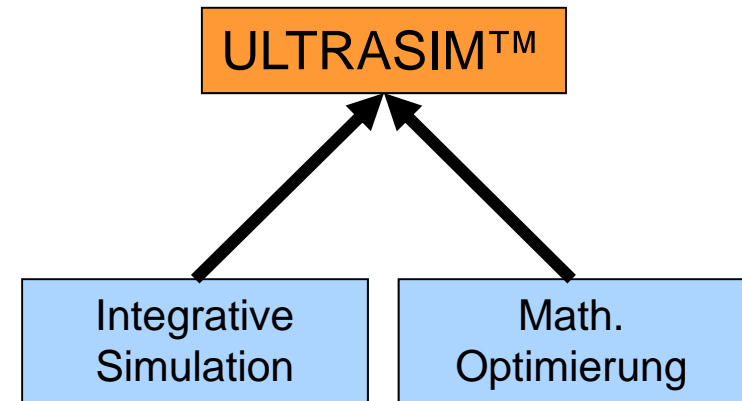
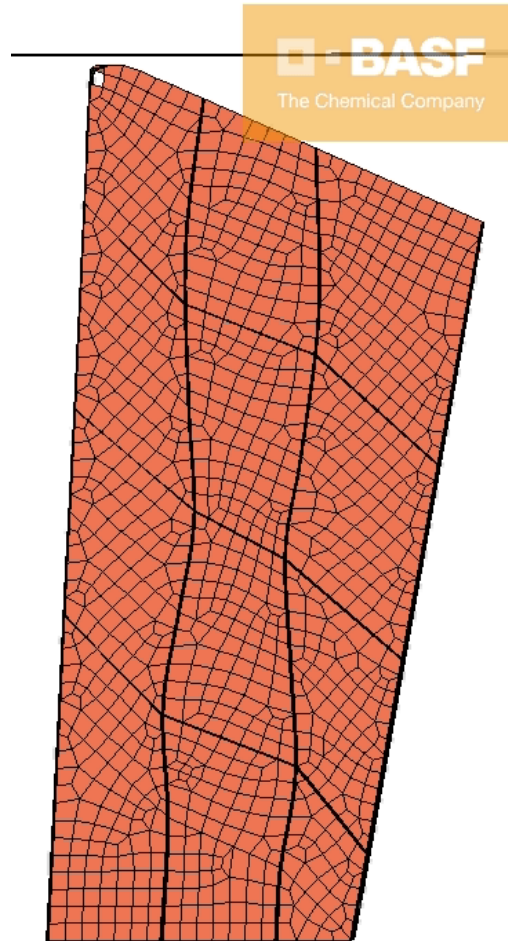
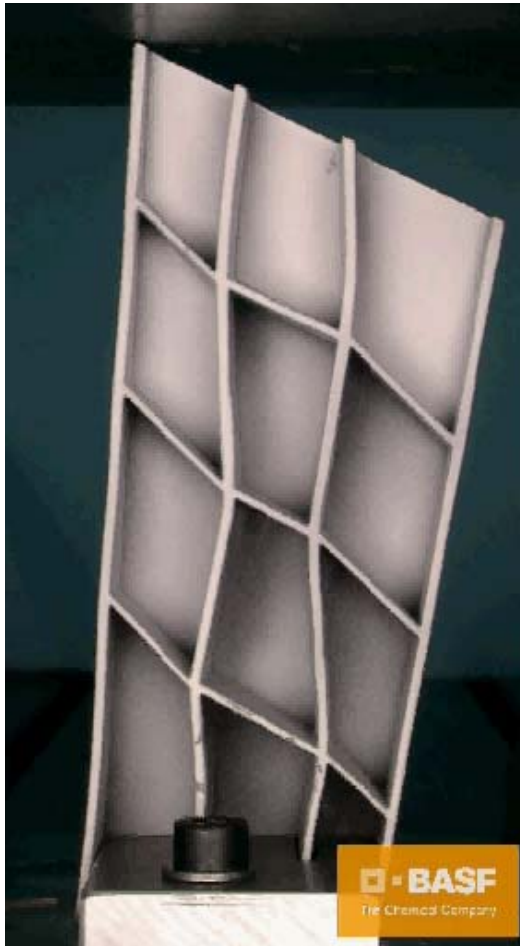

Dynamic Test Video

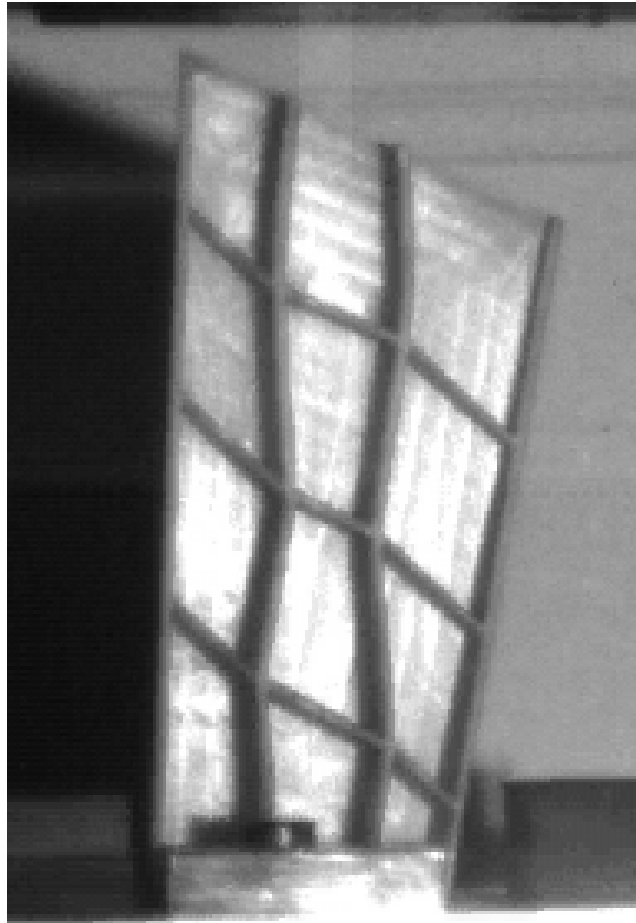

Drop mass: 60 kg
Drop height: 2.5 m
Drop Energy: 1.47 kJ
Duration: \approx 25 msec
Displacement: \approx 75 mm
Part weight: \sim 130gr



Parameter Optimization in CAE

Iterative process based on mathematical optimization methods

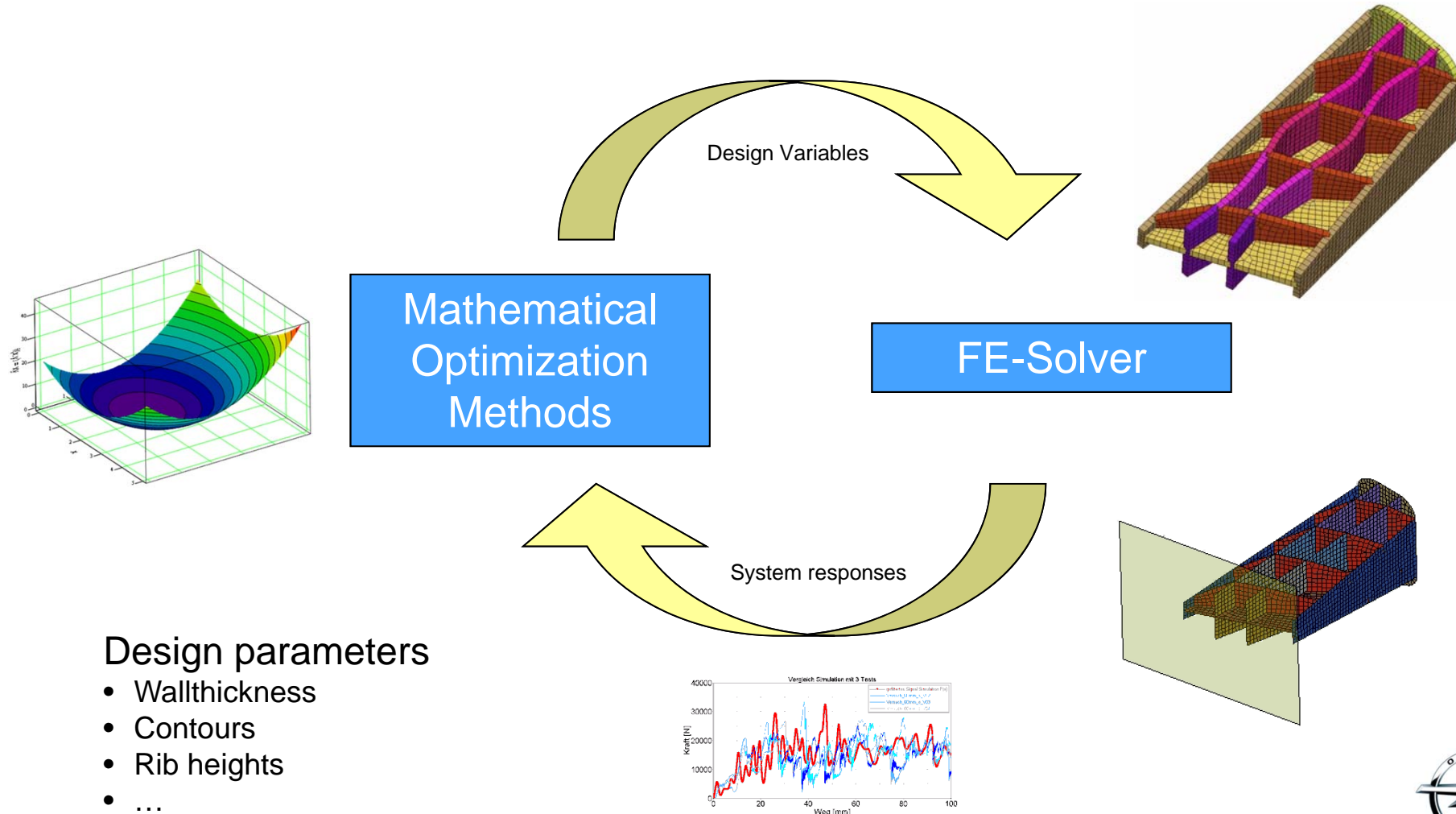

Shape Optimization using Morphing

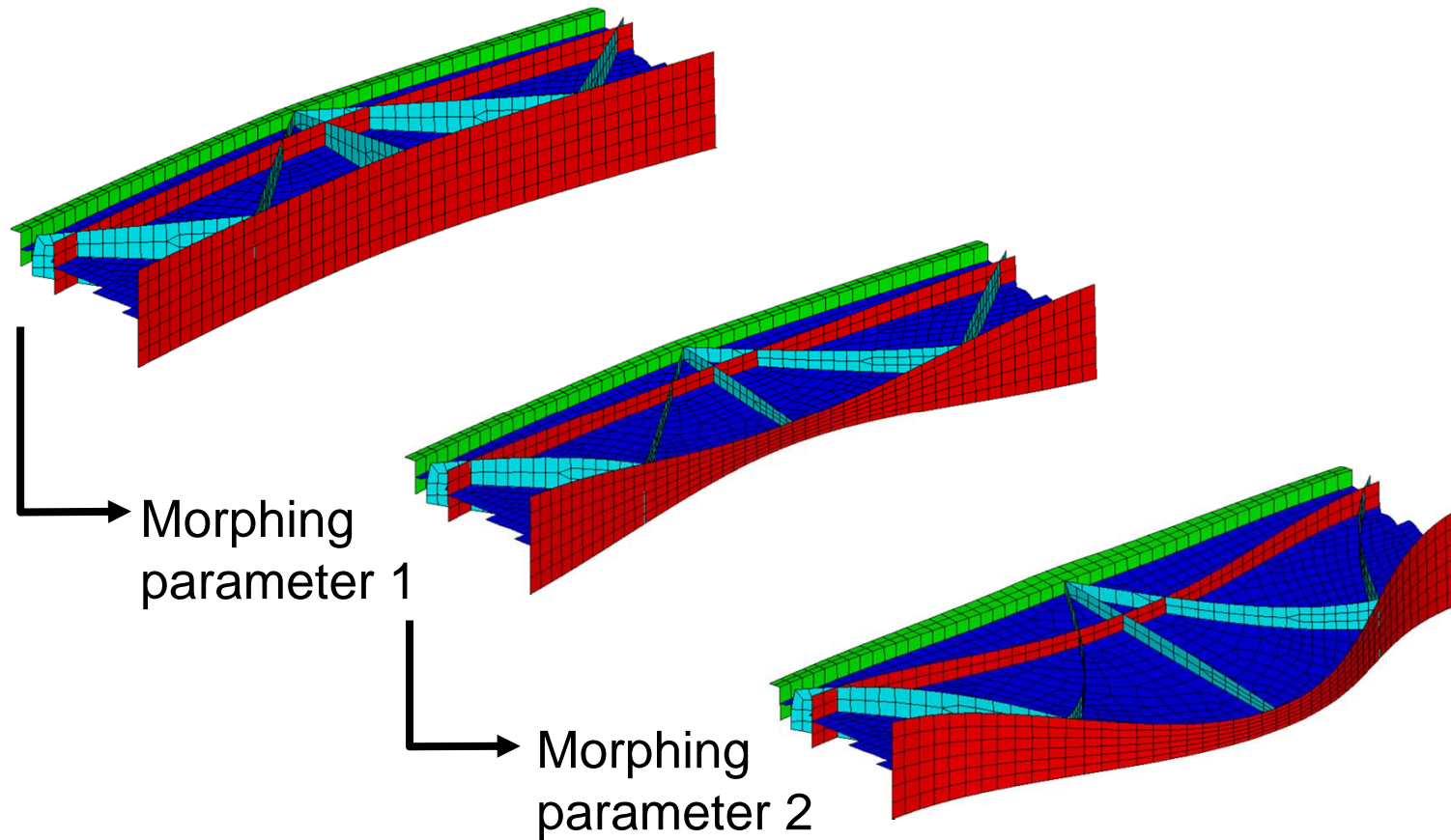

Vision – Integrative Optimization

Standard Optimization and Integrative Approach

Plastics granulate with glass fibers



Injection molding process



Part



Assembly



Product in use

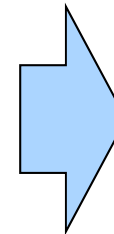
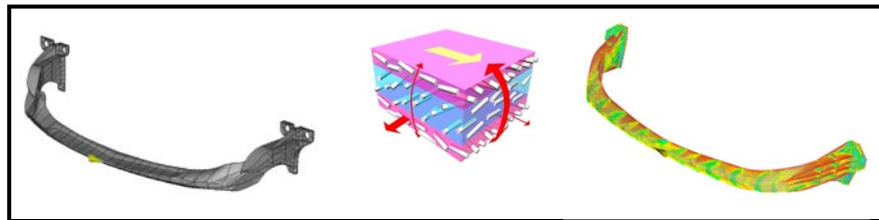

- Crash
- Static Loads
- NVH
- Warpage
- ...



Workflow for Standard Optimization Approach

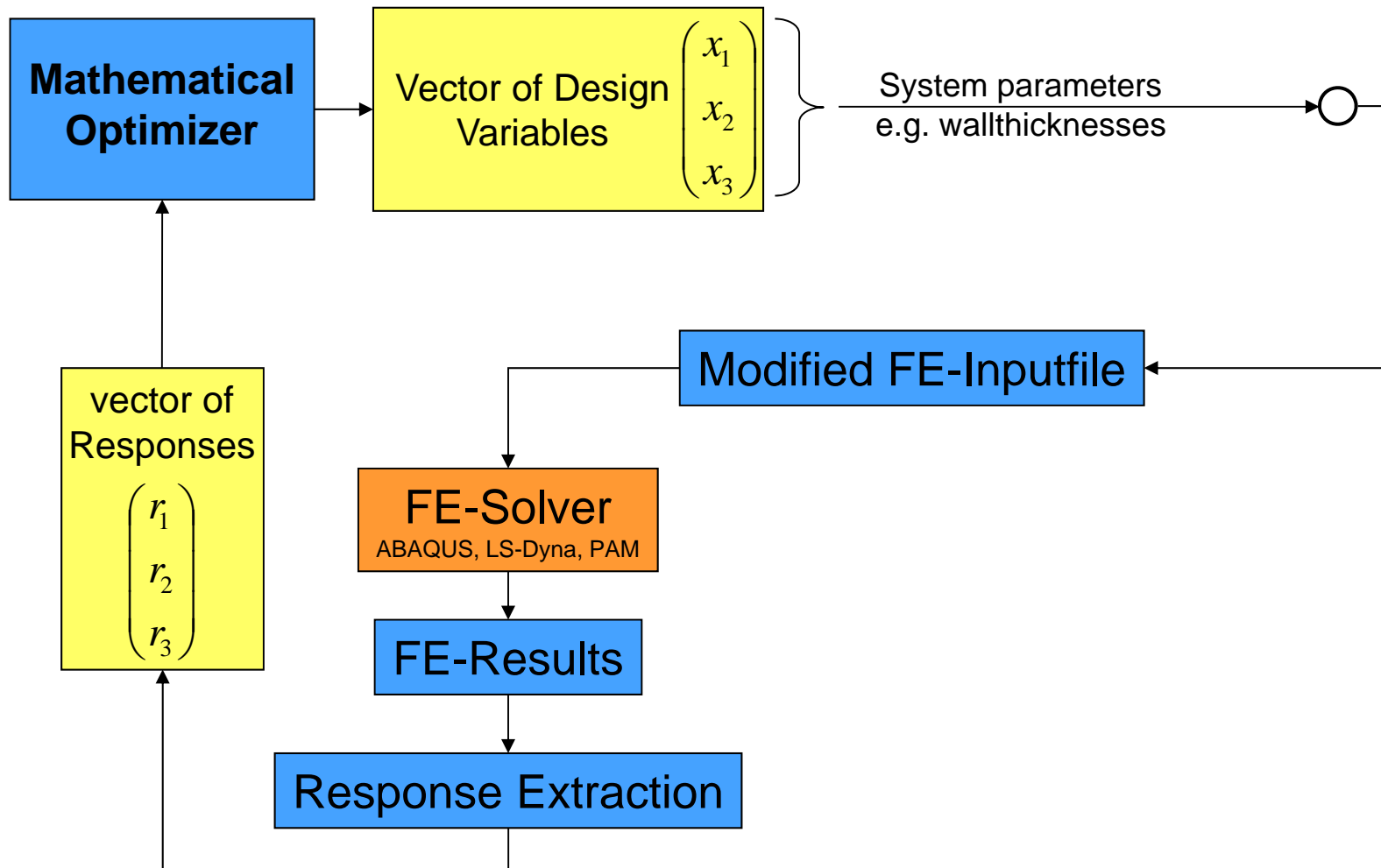

Workflow for Integrative Optimization Approach

Single disciplinary (without morphing)

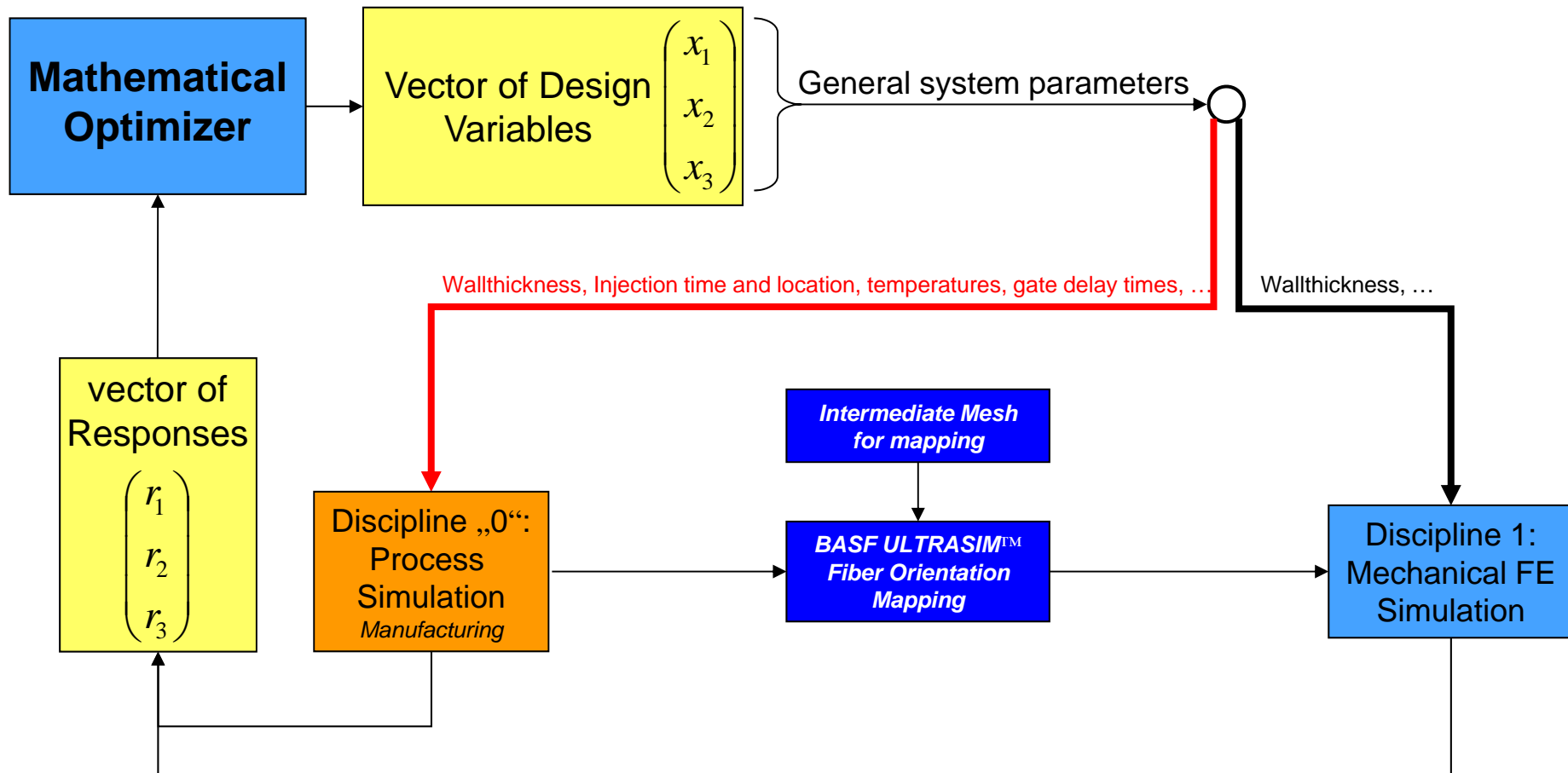

Integrative Optimization Example

Filling, Warpage, Impact, Static Load, Shape Optimization by Morphing
LS-OPT, MOLDFLOW, LS-Dyna, ANSA, ABAQUS

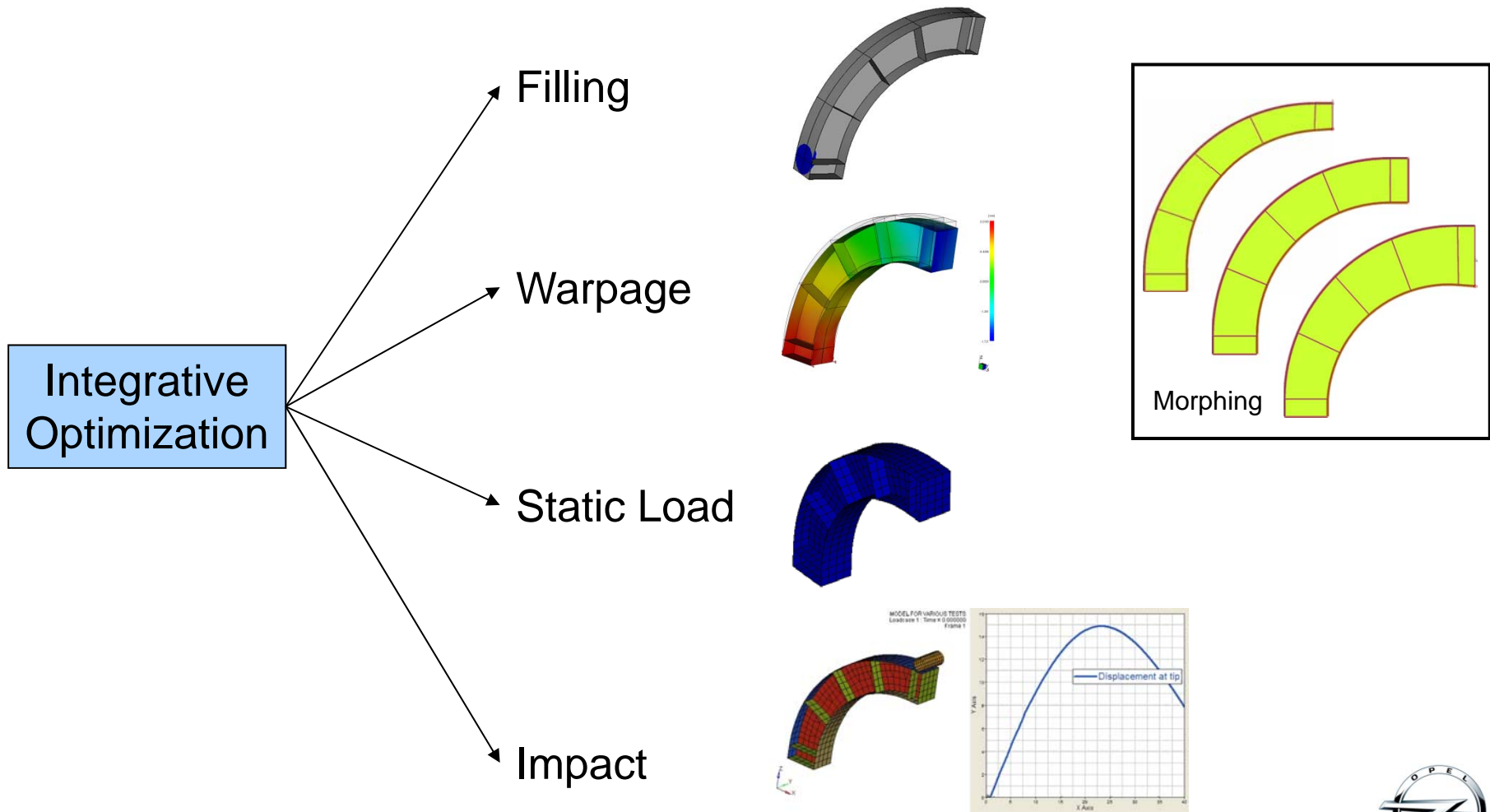

- **More and more structural vehicle parts are made of anisotropic polymers**
- **Injection molding process determines fiber orientation and thus local mechanical properties**
- **ULTRASIM™ approach has been applied for numerous applications**
 - **Initially: Lower bumper support for pedestrian protection**
 - **Extended to engine mounts and seats**
- **Simulation results show excellent correlation with physical tests**
- **Extended ULTRASIM™ failure model is crucial for the accurate design of energy absorbing structures**
- **Integrative Optimization Approach allows simultaneous optimization of process and mechanical characteristics**