

# From 6 months to 6 weeks "Multi Disciplinary Optimisation MDO" (Crash - NVH - Restraints)

Dr Tayeb Zeguer

Jaguar Landrover

## Summary:

The traditional new-vehicle design cycle is very time consuming due to the sequential approach used. The need to reduce time to market for new vehicles as well as the increased affordability of high-performance computing, which can process hundreds of simulations concurrently, has led to the increased adoption of MDO processes.

The goal of an MDO is to provide a more consistent, formalized process for complex system design than that found in traditional approaches, as well as to impact the design cycle through timely, performance-based direction. In essence, MDO aids in the management of the design process workflow itself.

The MDO principle allows engineers and analysts to address multiple vehicle attributes such as safety performance, refinement and failure modes e.g. full frontal, offset, side and rear impacts, occupant restraints and total vehicle level NVH.

This paper provides a formal and structured approach in the use of MDO at JaguarLandover to address complex and often conflicting requirements; arriving at better quality designs in a faster and more cost-effective manner.

The use of MDO solutions increases the efficiency of the simulation processes by the following:  
Automation of many manual simulation processes to save time.

Linking multiple simulation such as Crash, NVH and restraint to perform trade-off analyses  
Minimizing vehicle weight and meeting all vehicles attribute requirements.  
Find optimal designs and develop better products

## JLR Multi Disciplinary Optimisation

( NVH - Crash - Restraints )

From 6 months to 6 weeks

Tayeb Zeguer

## CAE Challenges in support for more great product faster

Development  
cycle must  
be reduced  
?



Failure  
modes have  
to be found  
and resolved  
earlier



### CAE Enablers:

- Faster model creation
- CPU
- Automation
- Material database
- CAE engineers
- Robustness
- Optimisation
- Validation
- Auto Assembly
- Morphing
- CAE PIM

## CAE future competitive position

- Model Auto Assembly
- Target Setting
- MDO multi disciplinary optimisation
- One model, One code for all Body Engineering attributes

## CAE Models

Following models are created for each design iteration  
 Extracted results are constrained or optimised

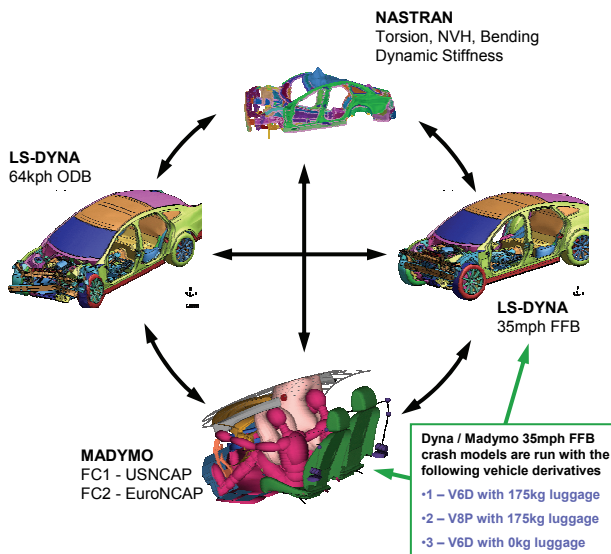

### Design Objectives

- Minimise Mass
- Maximise US/ EuroNCAP star rating

### Design Constraints

Meet all attribute targets and FAC constraints, eg:-

- Vehicle pulse and intrusion
- Occupant injuries
- Bending/ torsional stiffness
- Point dynamic stiffness
- Body natural frequencies

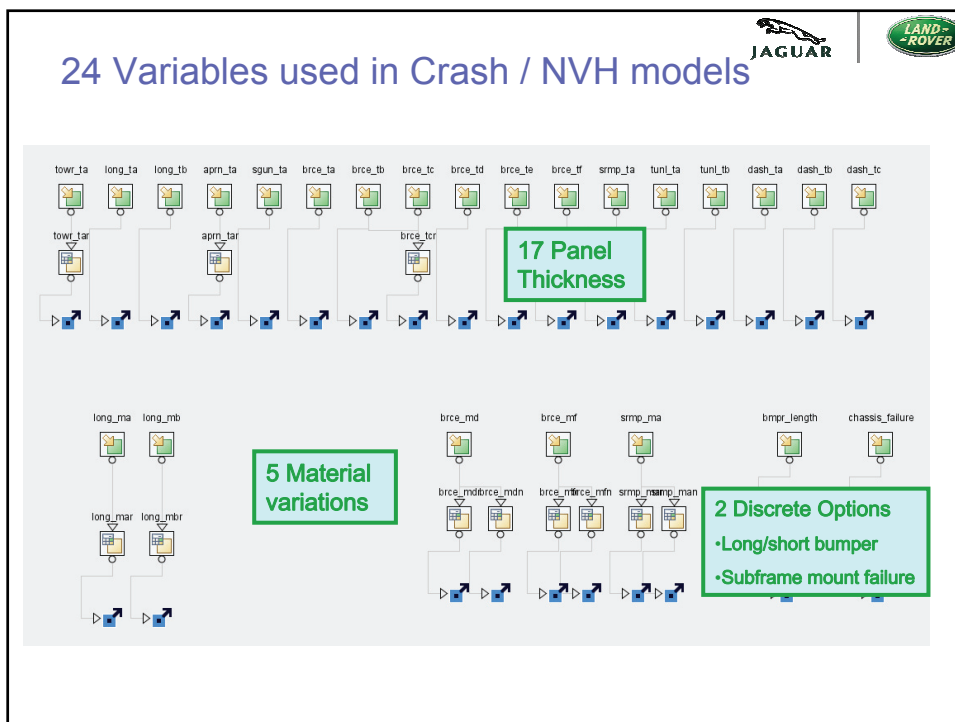
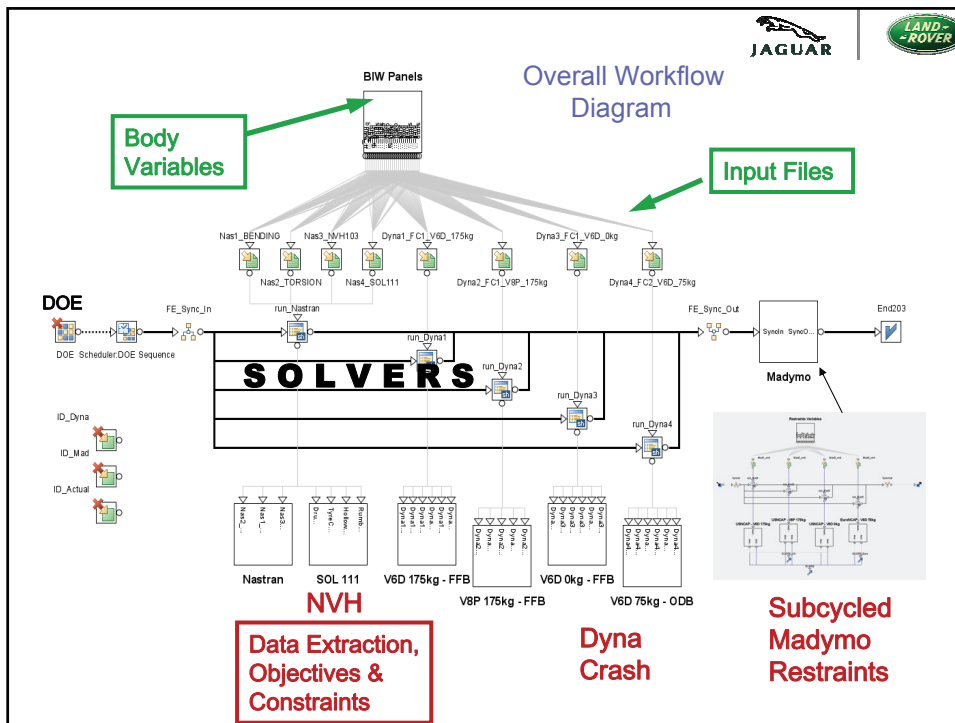

## Outputs Extracted from DYNA crash model

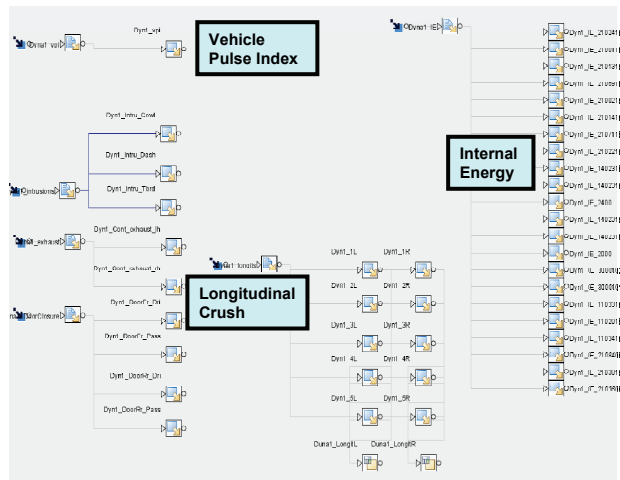

## Outputs Extracted from Nastran NVH model

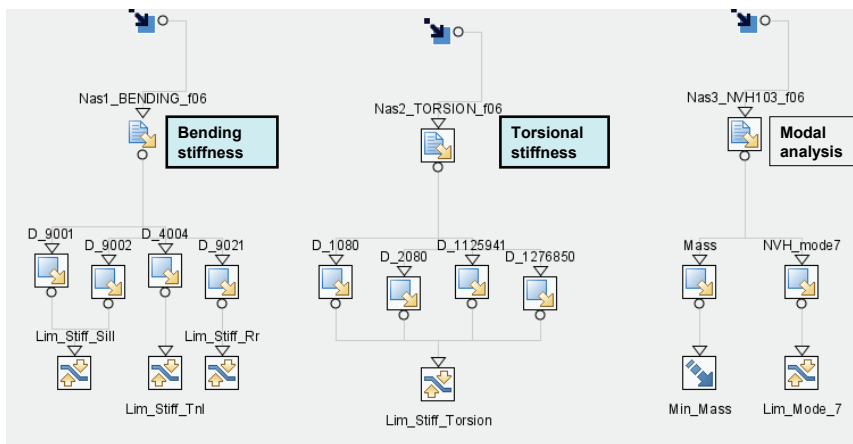

Dynamic stiffness (mobility) at chassis loading points was also calculated at 10 points through 4 frequency bands

## Variables used for Restraints models

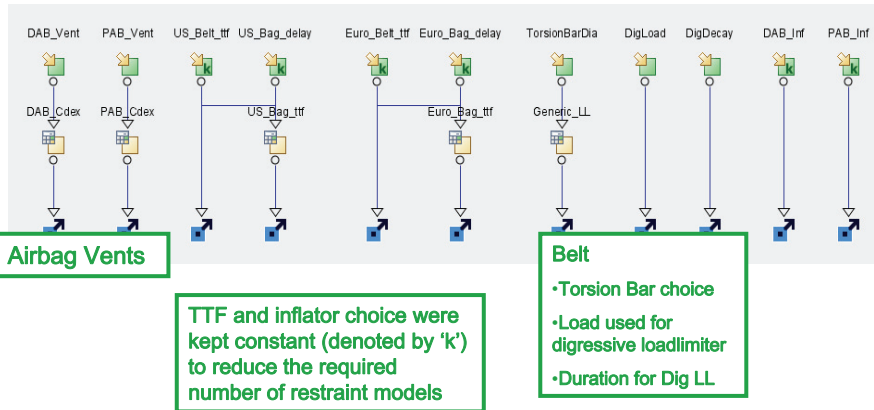

## Initial DOE

- Combining disciplines into such a study results in a large number of independent variables (n=82 in this first run).
- Even the simplest two level Full Factorial DOE would result in massive  $5e24$  runs!
- **Assuming very good distribution, a useful approximation for the number required is  $3xn = 246$ .**
- Selecting 246 well distributed points from this vast design space is a challenge. Many options were investigated; the best being adopted.



## Poor input correlation

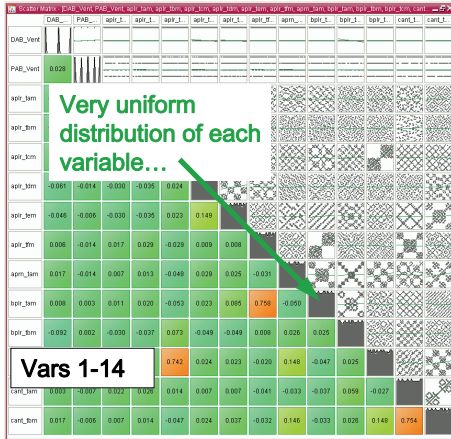

... but massive correlation can be seen between inputs - especially after the first few variables

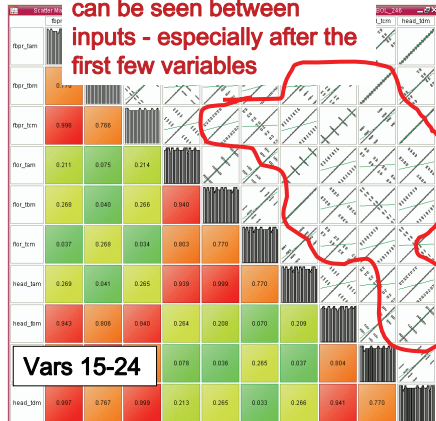

## Using D-Optimal criterion from a large random set





## Example of direct correlation between constraints

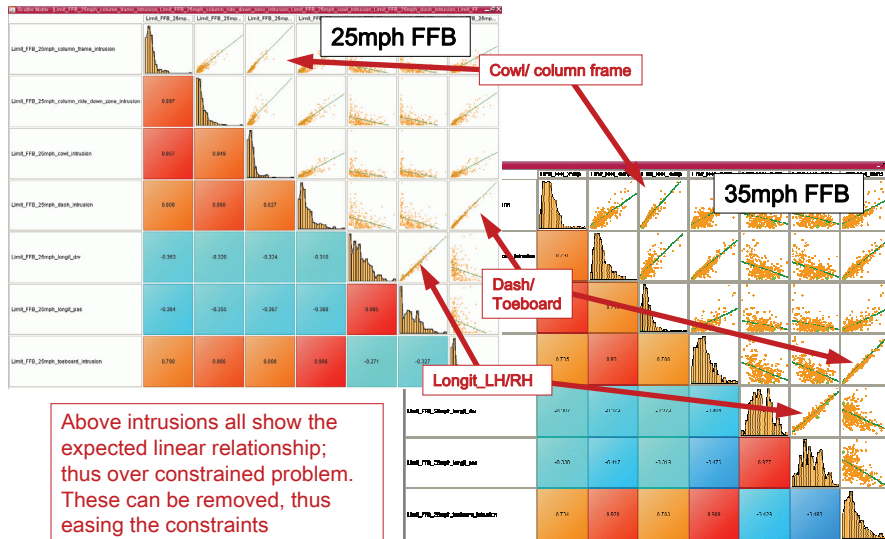

## Calculation of SCORE

For assessment of results and rating of 'best' variant

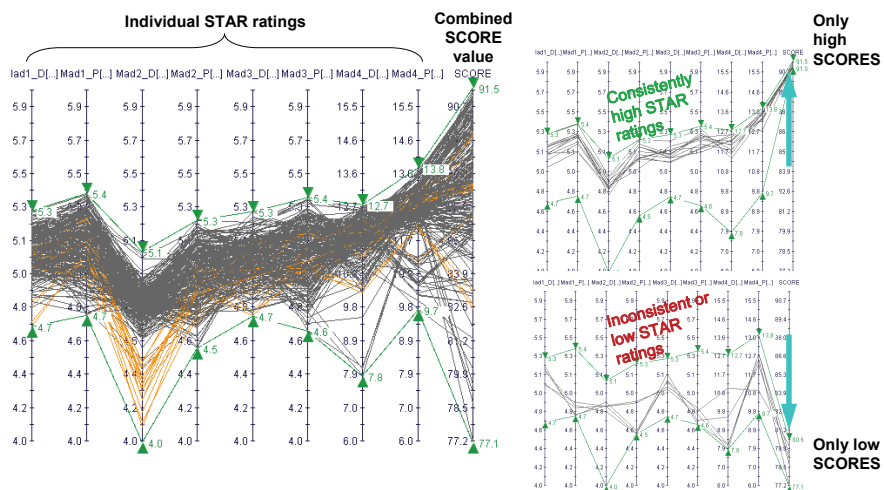



## Nastran results overview

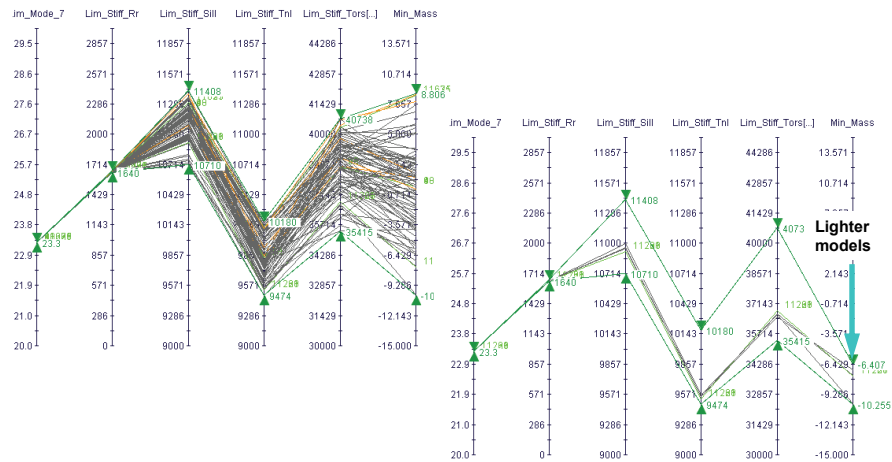

## Restraints performance v VPI

Vehicle Pulse Index as a measure of body performance

- VPI is a measure of the pulse severity.
- The target value of 63g should not be exceeded during the crash.
- VPI can not be used for EuroNCAP as these injuries are intrusion related.



## VPI Index is a valid measure of body crash performance

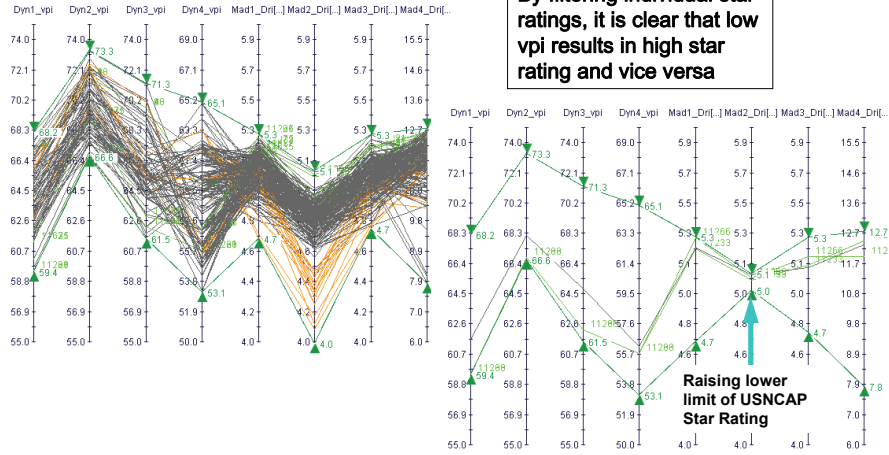

## V8P on USNCAP & V6D for EuroNCAP

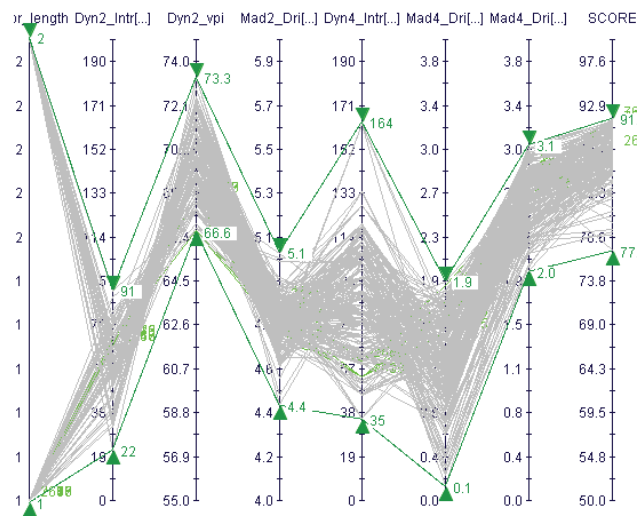

## Final filtering by SCORE and highlighting resulting models

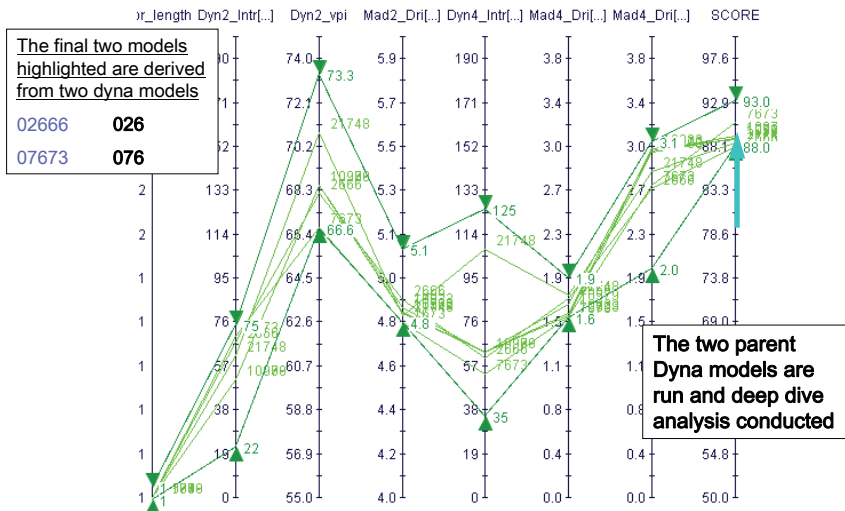

## RSM methods applied to find better solution

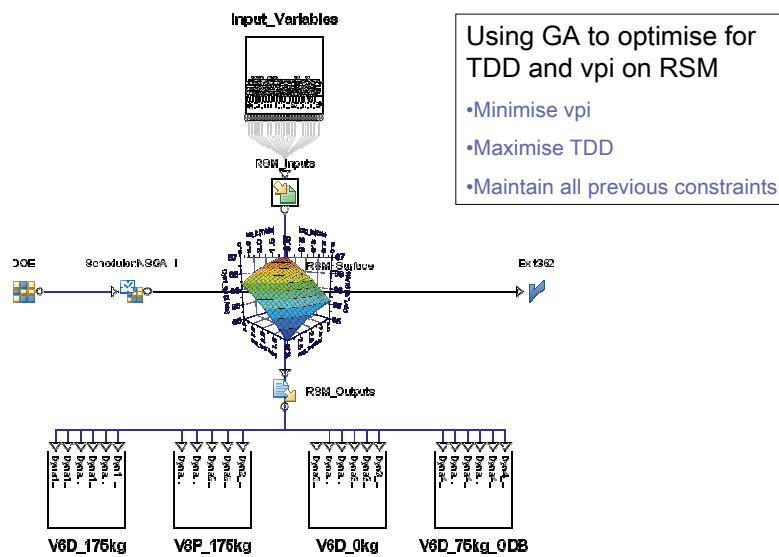

## Overview using vpi, TDD and ODB intrusions

Baseline, best of the DOE and actual DYNA models run to RSM best predictions

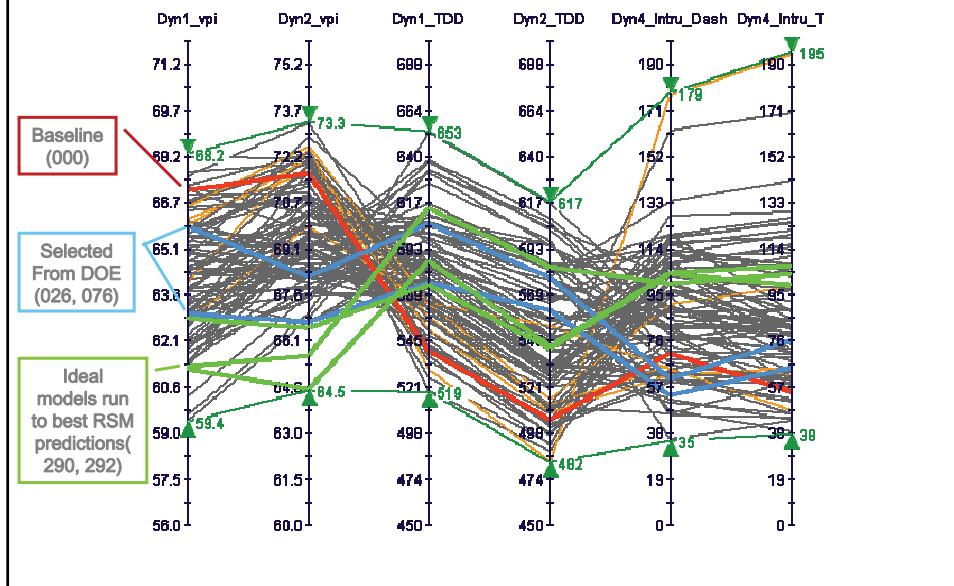

**While the MDO is running , CAE enabler can be developed**

**From 6 weeks to 2 hours  
Auto correlation on airbags**

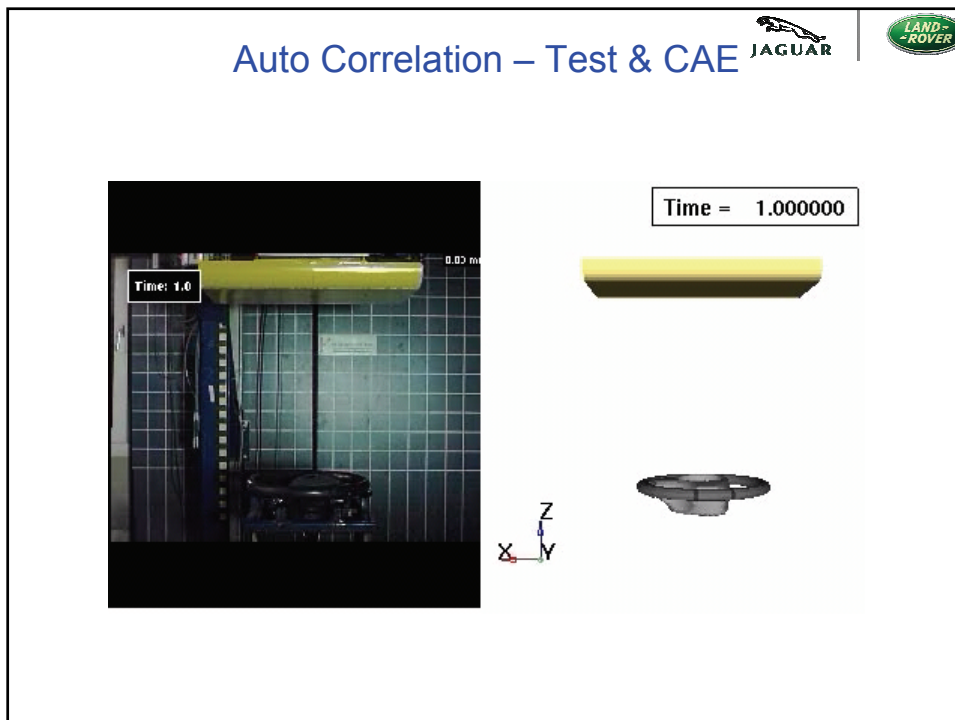
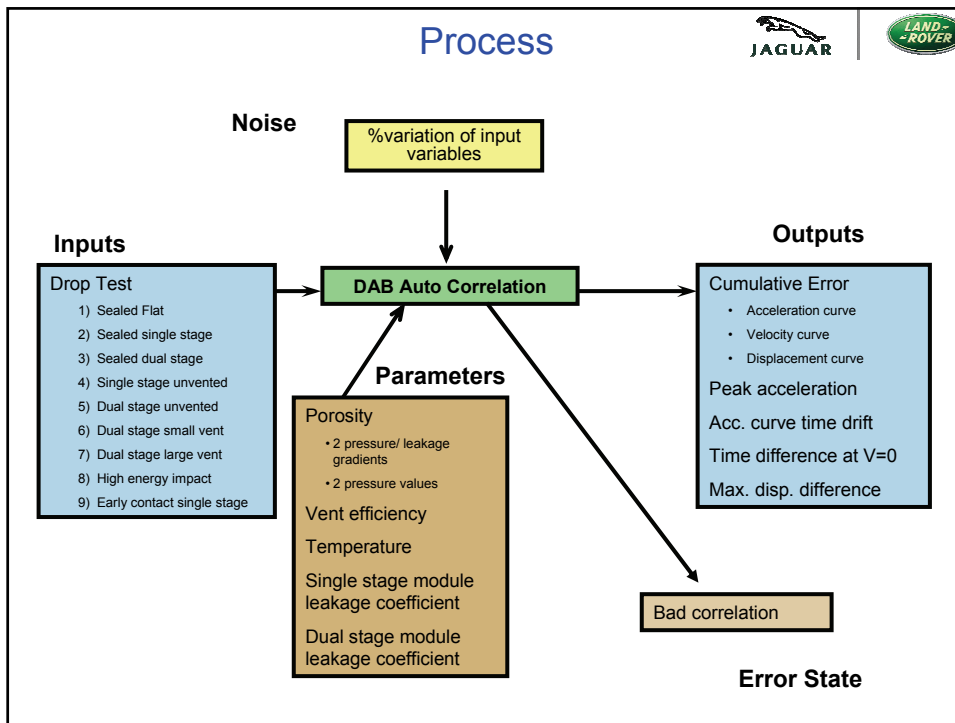

## Auto Correlation – Initial Values



After creating a model, checking the deployment visually and setting some nominal parameters the auto correlation process can begin.

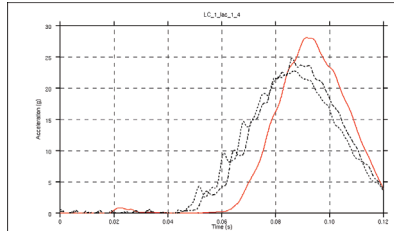

Load Case 1

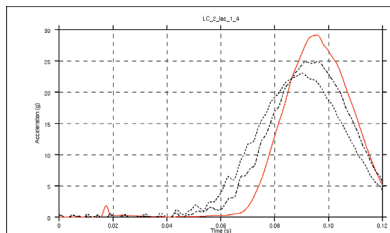

Load Case 2

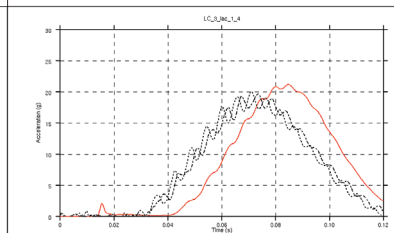

Load Case 3

## Parameters



Parameter	Lower Bound	Upper Bound
Temperature coefficient	0.6	1.0
Vent efficiency	0.6	1.0
Single stage module leakage	0.001	0.500
Dual stage module leakage	0.001	0.500
Porosity X2	0.01	0.06
Porosity dX3	0.01	0.03
Porosity gradient 1	0.5	5.0
Porosity gradient 2	0.5	5.0

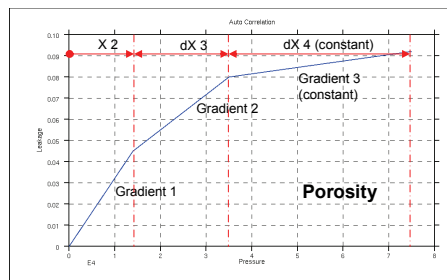

Porosity verses pressure curve defined by two gradients and 2 pressure values. A constant gradient tail is used to limit excessive gas los at the high pressures created in the airbag unfolding and so reduce the number of variables in the DOE.

## Objectives And Constraints



Peak values, time velocity equals zero and times of peaks are also used as constraints to control acceptable limits.

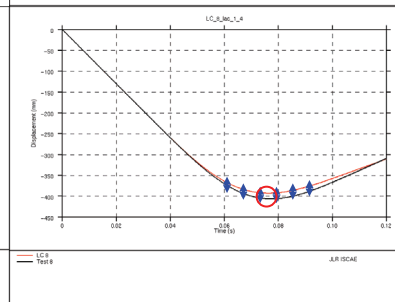
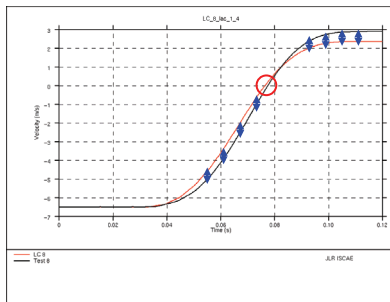
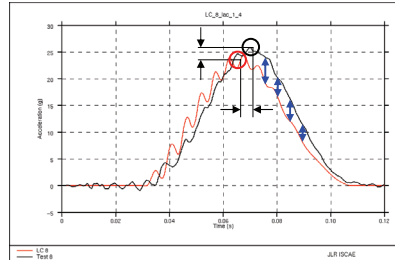

## Objective Function



Cumulative error function:

A modified least squares function normalised over the common range of the curves to give a total error score for the correlation of the test and simulation curve. No correlation gives a score of 1 while a perfect correlation gives a score of 0.

$$\xi = \frac{\sum_{i=1}^N (y_t - y_s)^2}{\sum_{i=1}^N y_t^2 + \sum_{i=1}^N y_s^2}$$

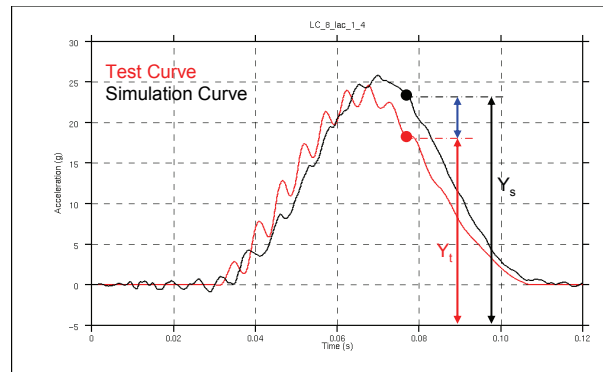

# Auto Correlation with multiple load cases



All load cases run in parallel with the same values of input and the output cumulative is then minimised for each load case.

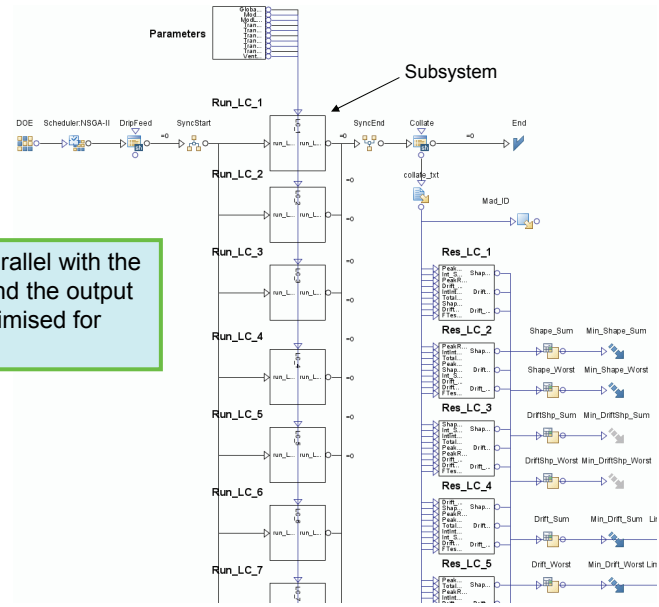

# Auto Correlation –Results



Excellent correlation against original test curves.

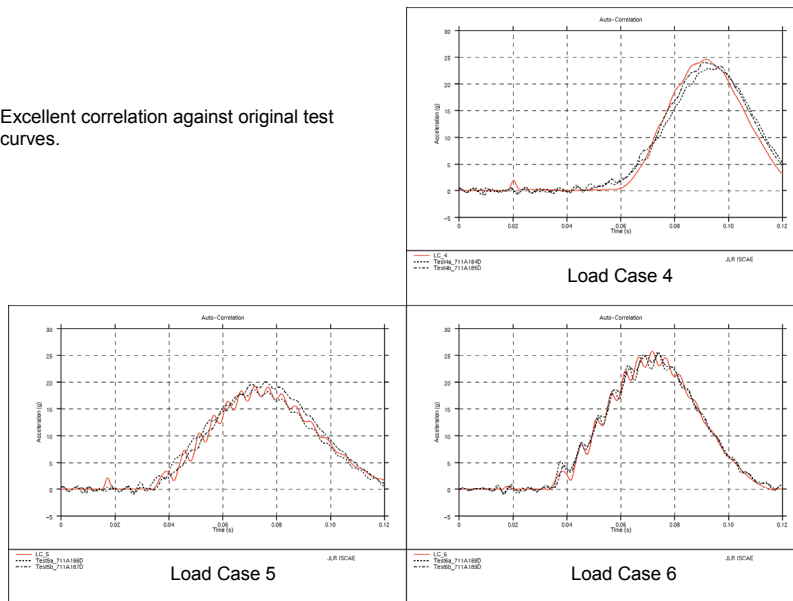



## Robustness Check



Reasonable variation of inputs have minimal effect on the quality of the correlation.

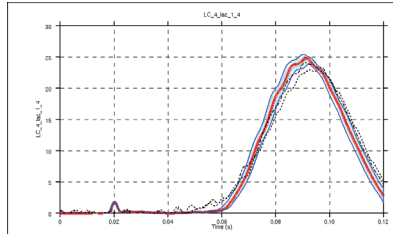

Load Case 4

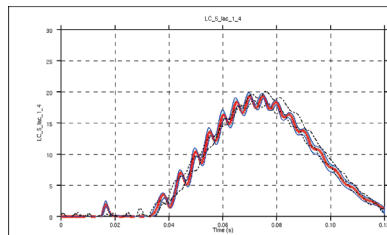

Load Case 5

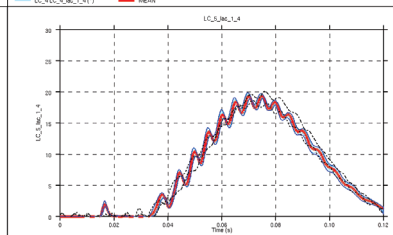

Load Case 6

## Conclusions



- MDO is a design by objective approach that is faster than traditional CAE that uses trial and error analysis to find satisfactory design.
- While MDO is running an auto correlate for a complex load cases was developed in a very short time from 6 weeks to 2 hours using the same MDO principle including robustness assessments.
- MDO has been successfully applied for Crash, NVH and Restraints in a very short time from 6 months to 6 weeks

## Conclusion



- Modefrontier has been successfully applied to auto correlate a complex load cases in a very short time from 6 weeks to 2 hours.
- Robustness assessment procedure has been included for the auto correlation.