

# A CONSTITUTIVE EQUATION FOR THE AGING OF ELASTOMER AND APPLICATION TO DUMMY IMPACT PROGRAMS <sup>1</sup>

William W. Feng  
John O. Hallquist  
Christoph Maurath  
Livermore Software Technology Corp.  
7374 Las Positas Road  
Livermore, CA 94551

## Introduction

A constitutive equation for chronorheologically simple materials that describes the aging and viscoelastic behaviors of elastomer is presented. A simulated numerical uniaxial relaxation test of a material at various aging stages has been performed. The simulated experimental results demonstrate the chronorheological effect and are used further to determine the material property functions in the constitutive equation. A test of an elastomer at various aging stages has been performed. It demonstrated the same effect as the simulated numerical example.

The applications of this constitutive equation to dummy impact programs are mentioned.

## Chronorheologically Constitutive Equation

For viscoelastic highly compressible constitutive equations, the principal Cauchy stresses are given by Feng and Hallquist [1]

$$t_i(t) = \frac{1}{J} \left\{ \sum_{j=1}^m \left[ C_j (\lambda_i^{b_j} - J^{-nb_j}) + \int_0^t g_j(t-\tau) \frac{\partial (\lambda_i^{b_j} - J^{-nb_j})}{\partial \tau} d\tau \right] \right\}, \quad i=1,2,3. \quad (1)$$

The material constants  $C_j$ ,  $b_j$  and  $n$  can be determined from long-term test data ( $t = \infty$ ) and  $g_j(t)$  can be determined from relaxation test data. For uniaxial tension or compression tests,  $t_2 = t_3 = 0$ , and  $\lambda_2 = \lambda_3$ , we have

$$\lambda_3 = \lambda_1^{-n/(2n+1)}. \quad (2)$$

---

<sup>1</sup> 8<sup>th</sup> European LS-DYNA Users Conference, Strasbourg - May 2011

Hence, the constant  $n$  can be easily determined from the relationships between stretch ratios test data. The material constants  $C_j$  and  $b_j$  can be determined from relationships between the Cauchy stress and stretch ratio.

The relaxation functions can be taken as a series of exponential functions. In order to reduce the number of constants that must be determined, the relaxation functions are assumed in the following form:

$$g_j(t) = C_j \left[ \sum_{m=1}^N R_m e^{-\gamma_m t} \right] = C_j G_j(t) \quad (3)$$

This equation also relates the viscoelastic properties with the elastic properties through the constants  $C_j$ . The material constants  $R_m$  are dimensionless and  $\gamma_m$  are decay constants. Hence,

$$t_i(t) = \frac{1}{J} \left\{ \sum_{j=1}^M C_j \left[ \lambda_i^{b_j} - J^{-nb_j} + \int_0^t G_j(t-\tau) \frac{\partial (\lambda_i^{b_j} - J^{-nb_j})}{\partial \tau} d\tau \right] \right\}, \quad i = 1, 2, 3. \quad (4)$$

In this paper it is postulated that the mathematical form is preserved in the constitutive equation for aging; however, two new material functions,  $C'_j(t_a)$  and  $G'_j(t_a, t)$  are introduced to replace  $C_j$  and  $G_j(t)$ . The aging time is denoted by  $t_a$ .

$$t_i(t_a, t) = \frac{1}{J} \left\{ \sum_{j=1}^M C'_j(t_a) \left[ \lambda_i^{b_j} - J^{-nb_j} + \int_0^t G'_j(t_a, t-\tau) \frac{\partial (\lambda_i^{b_j} - J^{-nb_j})}{\partial \tau} d\tau \right] \right\}, \quad i = 1, 2, 3 \quad (5)$$

These four functions are further related by:

$$\begin{aligned} C'_j(t_a) &= \alpha(t_a) C_j \\ G'_j(t_a, t) &= G_j[\beta(t_a)t] \end{aligned} \quad (6)$$

where  $\alpha(t_a)$  and  $\beta(t_a)$  are two new material properties that are functions of the aging time  $t_a$ . The material properties functions  $\alpha(t_a)$  and  $\beta(t_a)$  will be determined

with the experimental results. For determination of  $\alpha(t_a)$  and  $\beta(t_a)$ , Equation (2) can be written in the following form

$$\begin{aligned} \log t_i(t_a, t) &= \log \alpha(t_a) + \log t_i(t_a = 0, t \rightarrow \xi) \\ \log \xi &= \log \beta(t_a) + \log t \end{aligned} \quad (7)$$

Therefore, if one plots the stress versus time on log-log scales, with the vertical axis being the stress and the horizontal axis being the time, then the stress-relaxation curve for any aged time history can be obtained directly from the stress-relaxation curve at  $t_a = 0$  by imposing a vertical shift and a horizontal shift on the stress-relaxation curves. The vertical shift and the horizontal shift are  $\log \alpha(t_a)$  and  $\log \beta(t_a)$  respectively.

## Examples

Following are two examples, one for the numerical simulation, and one for the uniaxial test results of a softening material:

The first, a numerical simulation of aging tests, is shown in Figure 1.

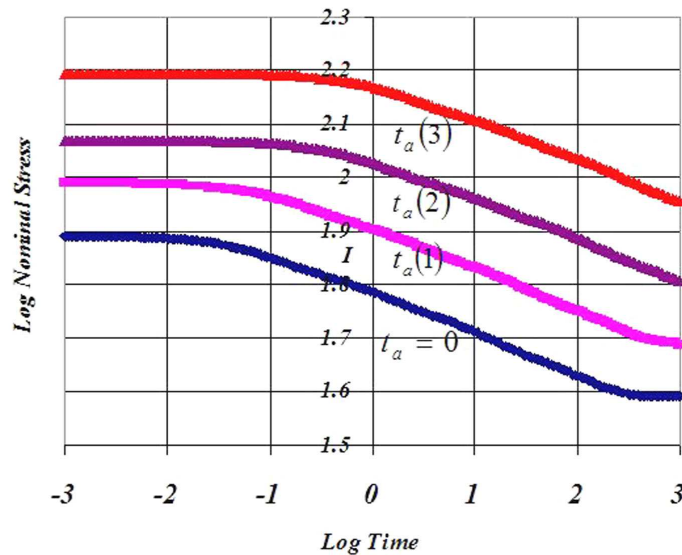

Figure 1, Numerical simulation of an aging test

After the vertical and horizontal shifts, the master curve where all aging test data collapse into a single curve, with  $t_a = 0$  as a reference, is shown in Figure 2.

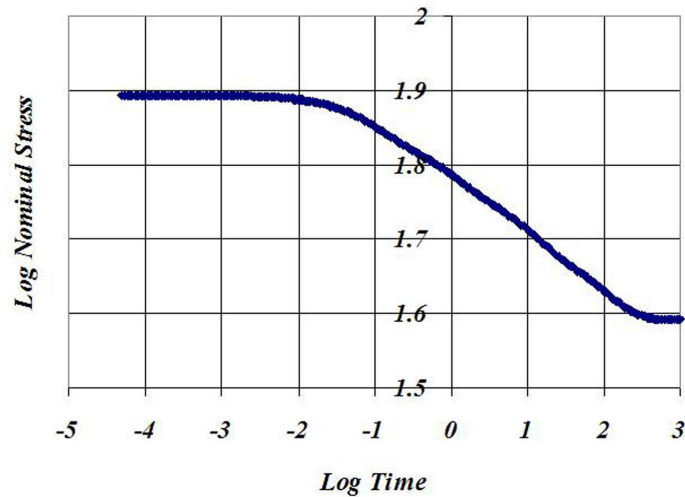

Figure 2, The master curve of the aging test, shown in Figure 1

The values for  $\alpha(t_a)$  and  $\beta(t_a)$  at various aging times are:

	$\alpha(t_a)$	$\beta(t_a)$
$t_a = 0$	1.00E+00	0.1000E+01
$t_a(1)$	1.25E+00	0.5000E+00
$t_a(2)$	1.50E+00	0.1000E+00
$t_a(3)$	2.00E+00	0.5000E-01

The values for  $\alpha(t_a)$  and  $\beta(t_a)$  between these aging times can be obtained from extrapolation between two adjacent values.

The second example is from uniaxial aging tests of a softening material; the material softens while aging. It is obtained from uniaxial-tension-relaxation tests. The force-time histories of these relaxation tests are shown in Figure 3. All test conditions are the same, except at various aging times.

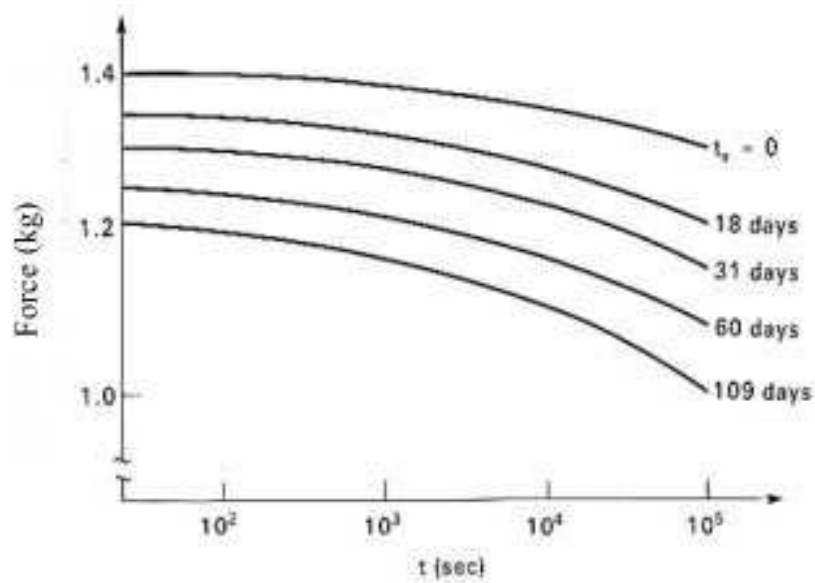

Figure 3, Uniaxial tensile tests of an elastomer at various aging times

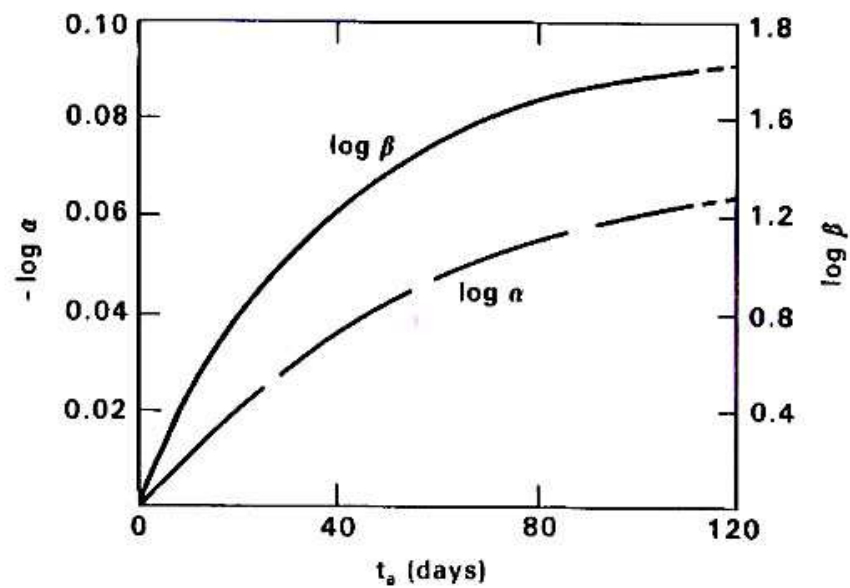

Figure 4, The values of the aging material properties,  $\log \alpha$  and  $\log \beta$ , versus the aging time  $t_a$

The same method illustrated in example 1 is applied here. The values of the aging material properties,  $\log \alpha$  and  $\log \beta$ , versus the aging time  $t_a$  are shown in Figure 4.

## Dummy program at LSTC

Examples of LSTC's dummy program are shown in Figures 5a and 5b. Both show the SID IIs dummy model. In Figure 5a the thorax impact calibration test is pictured. In Figure 5b the neck pendulum calibration test is shown.

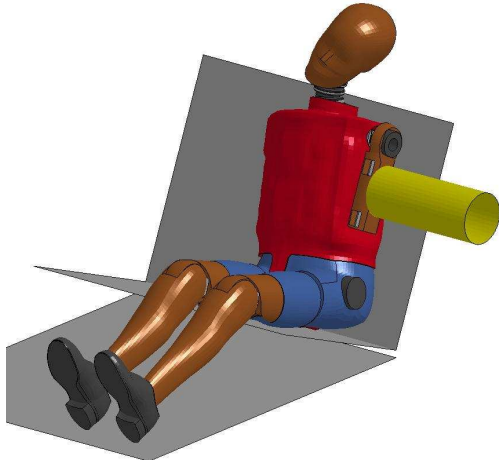

Figure 5a, Thorax impact test

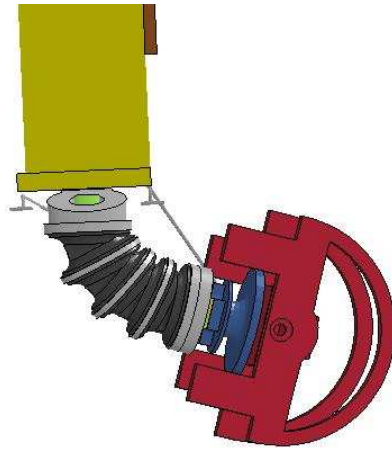

Figure 5b, Neck pendulum test

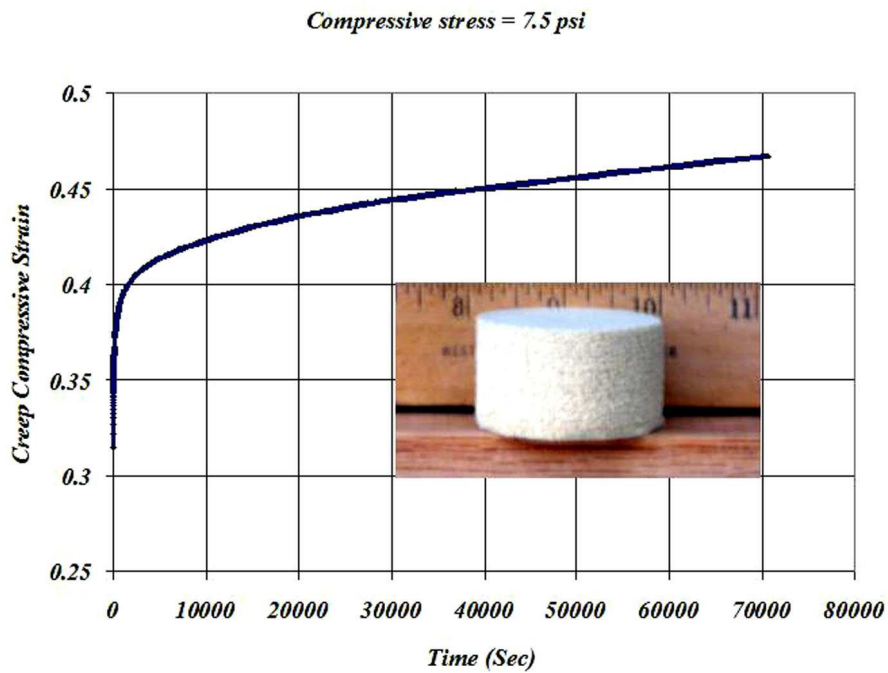

Figure 6, The creep test result of a foam used in the LSTC dummy program

The creep test result of a typical foam used in the LSTC dummy program is shown in Figure 6. It shows the viscoelastic behavior. Further analysis to determine the relaxation is shown in Figure 7. From the creep and relaxation phenomena the aging will affect these materials just as shown in examples 1 and 2.

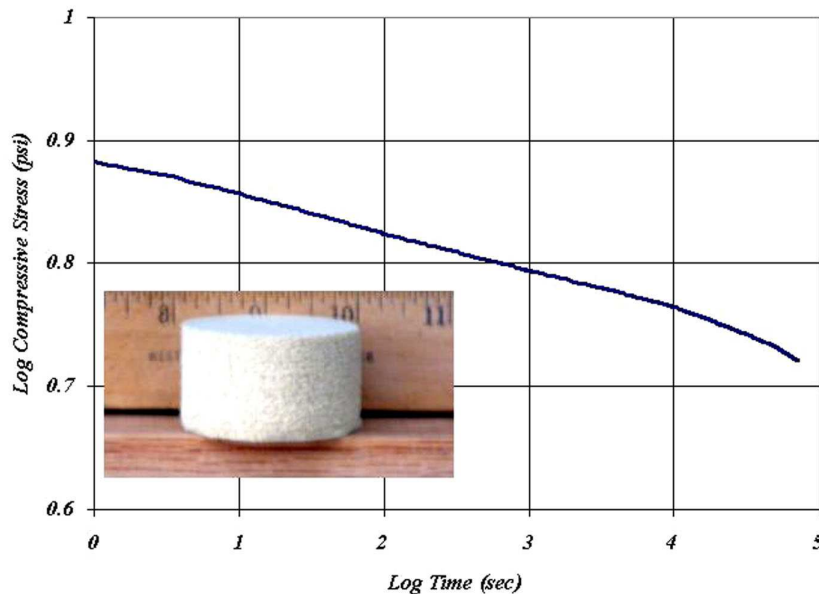

Figure 7, The relaxation of a foam, at 0.315 compressive strain, used in the LSTC dummy program

### **Future work**

Figure 8 displays sample comparisons of results from physical dummy calibration tests and calibration tests run with LSTC's SID IIs dummy model in LS-DYNA. The pictured results are from the neck pendulum calibration test shown in Figure 5b. They describe the angle between the pendulum arm and the headform replacement mass at the end of the neck, as well as the moment at the Occipital Condyle, the joint between the upper end of the spine and the head colored in blue in Figure 5b.

Although the correlations between LS-DYNA and the test for LSTC's dummy program are good as shown in Figure 8, the material used in constructing dummies will change with aging. Therefore it is important to know the aging properties of these materials.

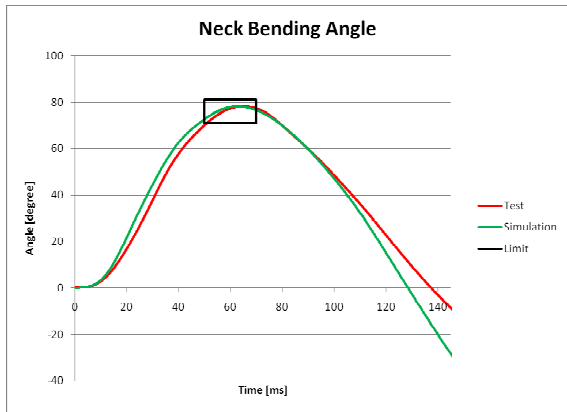

Figure 8a, Neck bending angle

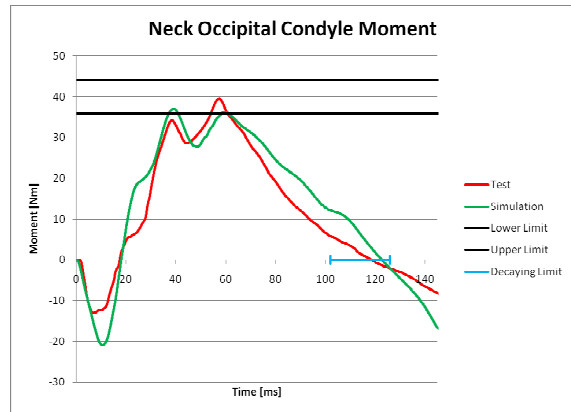

Figure 8b, Occipital Condyle moment

Several years ago, Toyota proposed studying the human dummy program. They proposed studying many human organs, as shown in Figure 9. Aging affects the mechanical properties of human organs greatly. Thus the chronorheological constitutive equation may be applied to that program as well.

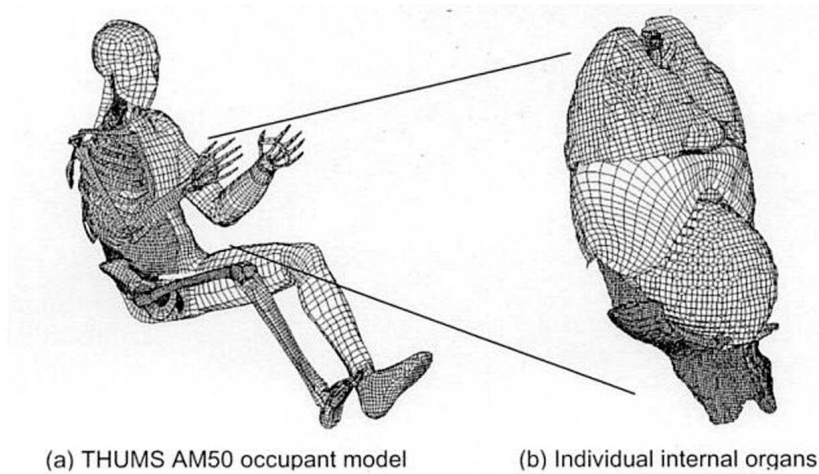

Figure 9, THUMS AM50 occupant model with individual internal organs

## Conclusions

The interpretation of the chronorheological properties of an elastomer has been obtained. The constitutive equation is shown in this report. A method for determining the aging properties is also presented. In the formulation, the geometric nonlinearity as well as the material nonlinearity is included.



The method described in this report can be extended readily to other types of aging and to other types of viscoelastic constitutive equations.

The beauty of this method is that the aging material functions  $\alpha(t_a)$  and  $\beta(t_a)$  can be obtained from any test method. They can be obtained from force-, or stress-relaxation curves for uniaxial tests; they can be obtained from pressure-relaxation biaxial tests; they can be obtained from other relaxation tests and creep tests as well.

## **References**

- [1] Feng, W. W. and J. O. Hallquist, "On Constitutive Equations for Elastomers and Elastomeric Foams," the 4<sup>th</sup> European LS-DYNA Conference, D-II-15, Ulm, Germany, May 22-23, 2003.